

COSMOS
s.r.l.

2017

**CABINE
DOCCIA**

SHOWER ENCLOSURES



Cosmos presenta la collezione di cabine doccia,
un essenziale complemento all'arredo dell'ambiente bagno.
Una gamma completa di modelli dal design moderno e lineare,
caratterizzati da una scelta di materiali e finiture di qualità
per rispondere ad un mercato sempre più esigente.

*Cosmos presents the shower boxes collection, an essential element in bath living.
A complete models range with modern and linear design, marked out by
material and finishing choices of quality, to correspond trade even more exigent.*



Consultazione Catalogo / Catalogue references

FINITURE ACRILICO
ACRYLIC GLASS FINISHING



Rugiada



Bollicine



Pioggia

FINITURE CRISTALLO
CRYSTALS FINISHING



(T)
Trasparente / Clear



(SA)
Satinato / Glazed



(GY)
Grey / Grey



(C)
Stampato / Printed



(SP)
**Specchio trasparente /
Transparent Mirror**



(SG)
Specchio grey / Grey mirror

new

SERIGRAFIE
SILK-SCREEN



(S1)
Oslo

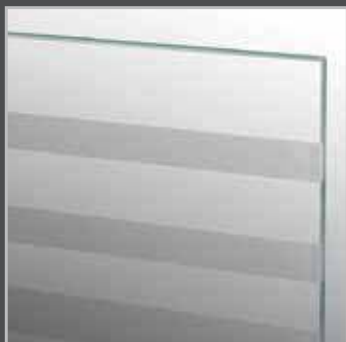

(S2)
Laguna



(S3)
Velo

COLORI DISPONIBILI
AVAILABLE COLOURS

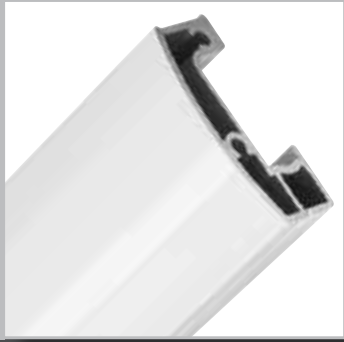

(BI)
Bianco / White

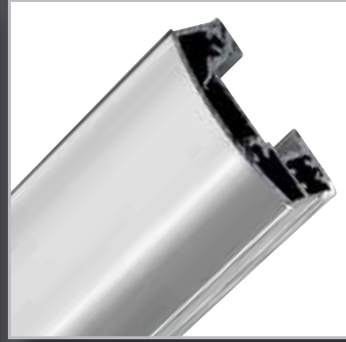

(ARL)
Argento lucido / Silver Polish

(ARGL)
Argento lucido Gloss 420 /
Gloss Silver Polish 420

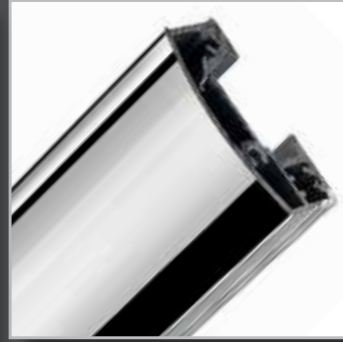

(CR)
Cromo lucido / Bright chrome



(ARS)
Argento satinato / Satin silver

I materiali / Materials

CRISTALLI / CRYSTALS

Vetro temperato:

Si ottiene tramite trattamento termico, prima di tutti i processi di taglio e lavorazione (forature, asole). Viene poi inserito nel forno di tempra a circa 640°C e successivamente raffreddato con aria fredda. Per questa ragione viene considerato vetro di sicurezza.

Temperated glass:

It's obtained with termic treatment, before processes of cutting and machining (drilling, slot). After it's put in a specific oven at 640°C and then refreshing with cold air. For this reason we can consider it security glass.

Tattamento idrorepellente:

Il procedimento viene effettuato sui cristalli nella parte interna della cabina doccia rendendo la superficie più resistente ai graffi e garantendo ai cristalli una brillantezza superiore. Durante l'utilizzo l'acqua scivola via più velocemente e con una semplice asciugatura dopo l'utilizzo si evita la formazione di macchie e aloni. Per la pulizia asciugare con un panno morbido, non utilizzare panni ruvidi per evitare di asportare il trattamento.

Water-repellent treatment:

This treatment it's carried out on crystals in the internal part of shower cabine and makes the surface more resistant to scratches, assuring the crystals a superior brightness. During the utilization water glide faster and with a little wiping after that is avoided from mark. Used a soft cloth for cleaning, don't use rough clothes.

ALLUMINIO / ALUMINIUM

I profili in alluminio utilizzati per la realizzazione delle cabine doccia Giava sono estrusi esclusivamente con materiale primario e si ottengono tramite matrici esclusive progettate da Giava. Il trattamento di verniciatura dei profili avviene con sgrassatura degli stessi e applicazione elettrostatica di polveri epossidiche, fissate tramite passaggio in forno, polimerizzando garantiscono la resistenza nel tempo. La brillantatura e la satinatura sono ottenute a mezzo processi di spazzolatura dei profili rendendoli lucidi. Il fissaggio della finitura viene effettuato tramite trattamenti chimici.

Aluminium profiles used for Giava shower cabines are exclusively extruded with primary material and they're obtained started from specific matrixes designed by Giava. Painting profiles treatment it's made by degreasing of them and electrostatic application of epoxy powders, fixed by a passage in a special oven, that polymerization guaranteed the resistance over time. Brightness and satinizing are obtained with brushing processing of profiles that rendered them polished. Finish fixing it's made with chemical treatment.

Tabella composizione codici articolo Composition table item codes

CODICE CODE	ESTENSIBILITÀ cm EXTENSIBILITY cm	APERTURA cm OPENING cm	FINITURA LASTRA GLASS	PROFILI - PREZZO € PROFILES - PRICE €			
				BIANCO (BI) WHITE (Bi)	ARGENTO SATINATO (ARS) SILVER SATIN (ARS)	ARGENTO LUCIDO (ARL) SILVER POLISH (ARL)	CROMO LUCIDO (CRL) CROME POLISH (ARL)
SS 01/S	63/68	53	ACRILICO/ACRYLIC BOLLICINE	218,00	-	-	-
SS 01	68/73	58		218,00	-	-	-
SS 02	73/78	63		218,00	-	-	-
SS 03	78/83	68		218,00	-	-	-
SS 04	83/88	73		218,00	-	-	-
SS 05	88/93	78		218,00	-	-	-
SS 06	93/98	83		218,00	-	-	-
SS 07	98/103	88		218,00	-	-	-
SS 08/S	63/68	53	C	244,00	275,00	-	-
			T	283,00	343,00	-	-
			S	311,00	377,00	-	-
			C	244,00	275,00	-	-
			T	283,00	343,00	-	-
			S	311,00	377,00	-	-

SS08/S

T

ARS

(DX)

DX o SX non sempre necessario
DX o SX not always necessary



3 STELLE
Grado tenuta acqua
OTTIMO

3 STARS
Able water holding
EXCELLENT

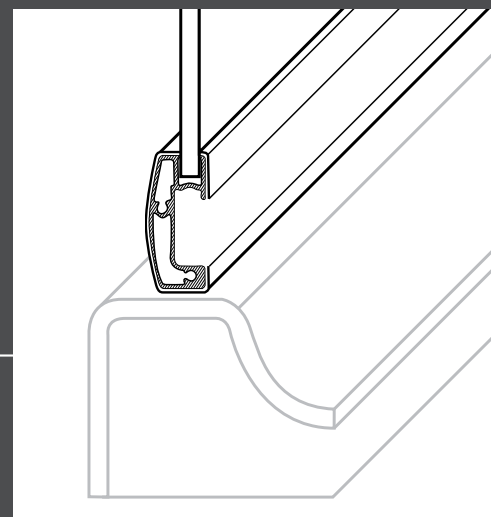

2 STELLE
Grado tenuta acqua
BUONO

2 STARS
Able water holding
GOOD

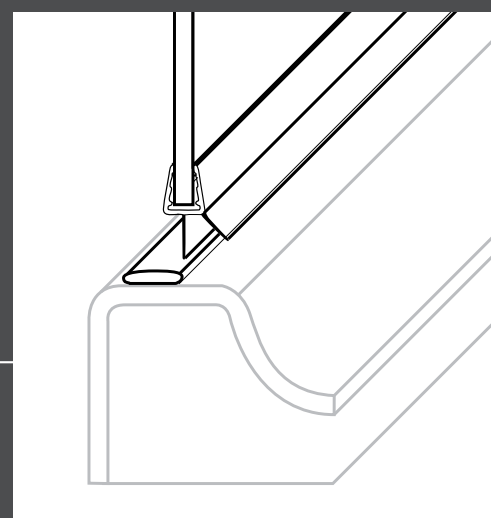

2 STELLE
Grado tenuta acqua
BUONO

2 STARS
Able water holding
GOOD

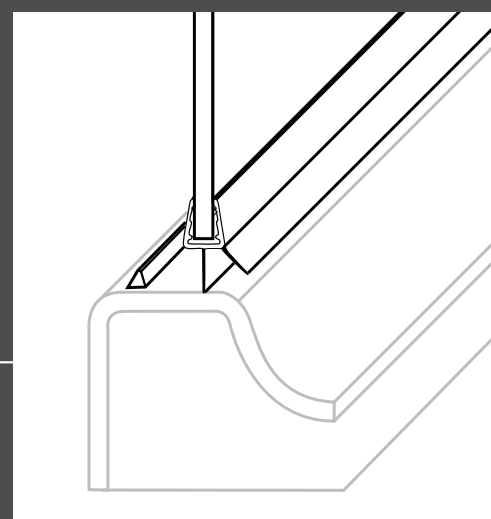

Legenda / Legend

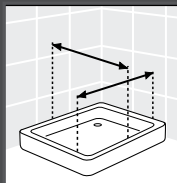

Misurare da muro bordo interno piatto doccia

Take measures
between wall and
interior tray edge

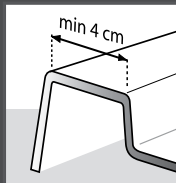

Larghezza del bordo piatto doccia ≥ 4 cm

Shower tray edge
 ≥ 4 cm width

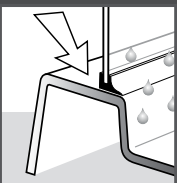

Allineare la parete al bordo interno del piatto doccia

Put shower wall in line with
interior shower tray edge

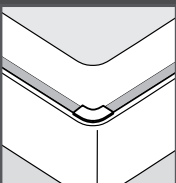

Profilo di tenuta supplementare per bordo piatto doccia

Additional water tight
profile for shower
tray edge

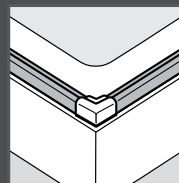

Profilo di tenuta supplementare per bordo piatto doccia

Additional water tight
profile for shower
tray edge

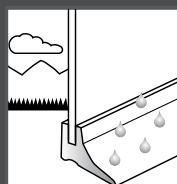

Guarnizione di tenuta acqua

Watertight gasket

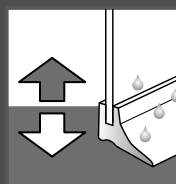

Porta con meccanismo saliscendi

Door with up and down
movement



Grado di tenuta all'acqua

Degree of water resistance

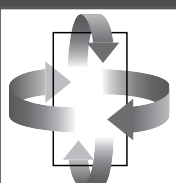

Articolo reversibile

Reversible
article



Chiusura magnetica

Magnetic closure



Trattamento idrorepellente

Water repellent
treatment

SOMMARIO / SUMMARY

PIATTI DOCCIA	6
ITACA	16
ITACA ELITE	34
FIJI	44
ALICUDI	58
TONGA	68
DOMINGO	82
LIPARI	92
CRETA	108
MIAMI 4 (fino a termine scorte)	120
SMERALDA	128
SOPRAVASCA	140
SPECIAL	151
MOVE	154
PROFILI & RICAMBI	158
CONDIZIONI GENERALI	170



PIATTI DOCCIA

SIENA

Mineral Marmo e resine, finitura effetto bugnato
Profondità 70-80-90 spessore 3 cm

*Mineral Marble and resins, finishing ashlar
effect depth 70-80-90 thickness 3 cm*

FIRENZE

Mineral Marmo e resine, finitura effetto pietra
Profondità 70-80-90 spessore 3,5 cm

*Mineral Marble and resins, finishing stone effect,
depth 70-80-90 thickness 3,5 cm*





SIENA



I piatti doccia SIENA, posati in appoggio o filo pavimento creano armonia nel vostro ambiente bagno. Vengono realizzati in conformità alla norma UNI EN 14527, quali requisiti di svuotamento d'acqua, stabilità del fondo, resistenza agli agenti chimici macchianti e alla durabilità. Adattabile ad ogni spazio, possibilità di taglio in cantiere, mediante utensili idonei.

Shower trays SIENA, simply put on the floor or in line they create a particula harmony in your bathroom. Produced in conformity with norm UNI EN 14527, that includes requirements for water emptying, floor bed stability, chimical staining agents resistance and lastingness.

Suitable with every space, possibility to cut them on the building yard thanks to suitable cutting tools.

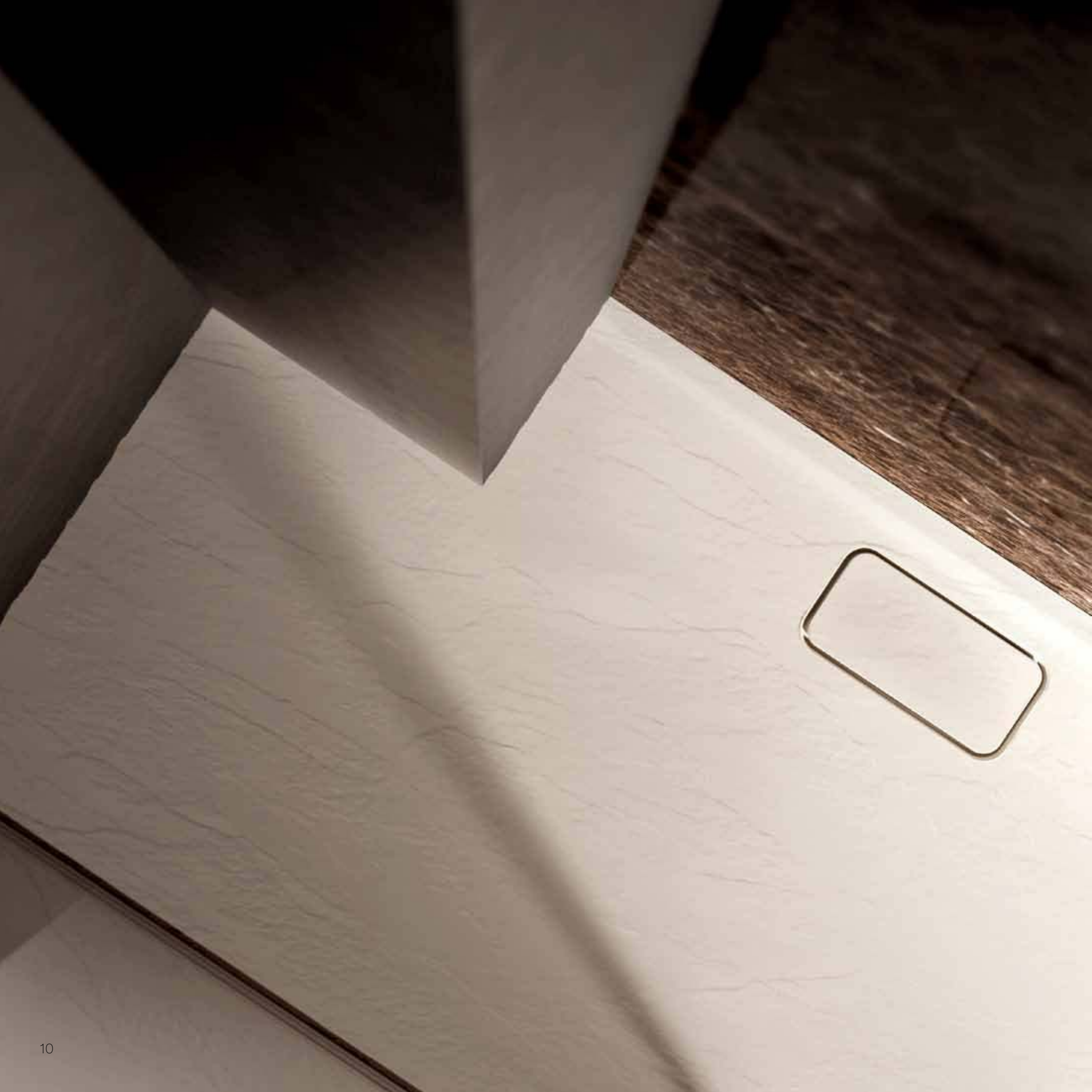

FIRENZE



I piatti doccia FIRENZE, sono personalizzati nella forma e nella loro dimensione, adattabili alle più svariate esigenze del vostro ambiente bagno. Realizzati in conformità alla norma UNI EN 14527.

Shower trays FIRENZE are customized because of form and dimension, suitable with every different needs of your personal bathroom. Produced in conformity with norm UNI EN 14527.

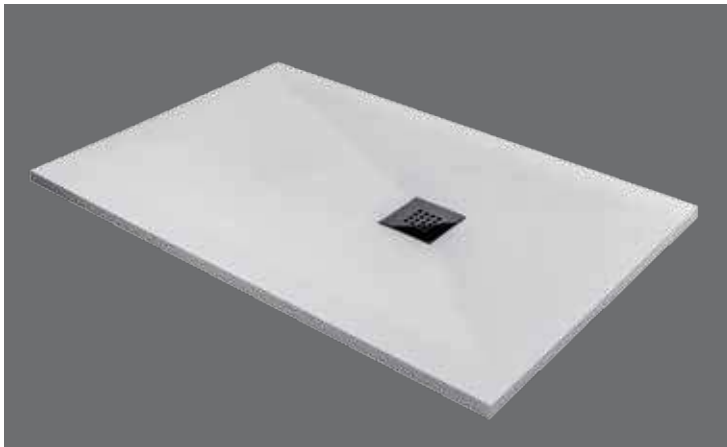

SIENA

Mineral Marmo e resine, finitura effetto bugnato
Profondità 70-80-90 spessore 3 cm

*Mineral Marble and resins, finishing ashlar
effect depth 70-80-90 thickness 3 cm*



(BI)
Bianco / White



(AN)
Antracite / Antracite



(GR)
Grigio / Grey



(AV)
Avorio / Ivory

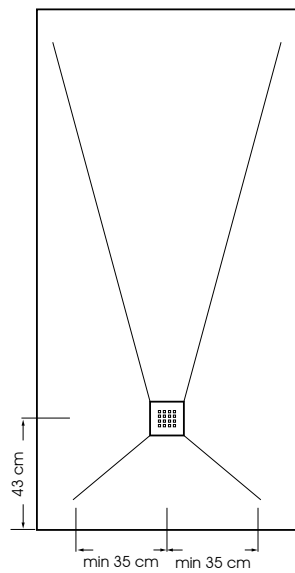

CODICE CODE	DIMENSIONI cm DIMENSIONS cm	PROFILI - PREZZO € PROFILES - PRICE €
		BIANCO (BI) - ANTRACITE (AN) - GRIGIO (GR) - AVORIO (AV) WHITE (BI) - ANTRACITE (AN) - GREY (GR) - IVORY (AV)
SE7 01	70X90	528,00
SE7 02	70X100	585,00
SE7 03	70X120	703,00

CODICE CODE	DIMENSIONI cm DIMENSIONS cm	PROFILI - PREZZO € PROFILES - PRICE €
		BIANCO (BI) - ANTRACITE (AN) - GRIGIO (GR) - AVORIO (AV) WHITE (BI) - ANTRACITE (AN) - GREY (GR) - IVORY (AV)
SE8 02	80X100	668,00
SE8 03	80X120	802,00
SE8 04	80X140	934,00
SE8 05	80X150	1003,00
SE8 06	80X160	1070,00
SE8 07	80X170	1135,00
SE8 08	80X180	1204,00
SE8 09	80X200	1336,00

CODICE CODE	DIMENSIONI cm DIMENSIONS cm	PROFILI - PREZZO € PROFILES - PRICE €
		BIANCO (BI) - ANTRACITE (AN) - GRIGIO (GR) - AVORIO (AV) WHITE (BI) - ANTRACITE (AN) - GREY (GR) - IVORY (AV)
SE9 02	90X100	829,00
SE9 03	90X120	954,00
SE9 04	90X140	1066,00
SE9 05	90X150	1127,00
SE9 06	90X160	1205,00
SE9 07	90X170	1267,00
SE9 08	90X180	1355,00
SE9 09	90X200	1506,00

Forme e dimensioni adattabili
Adaptable shapes and sizes

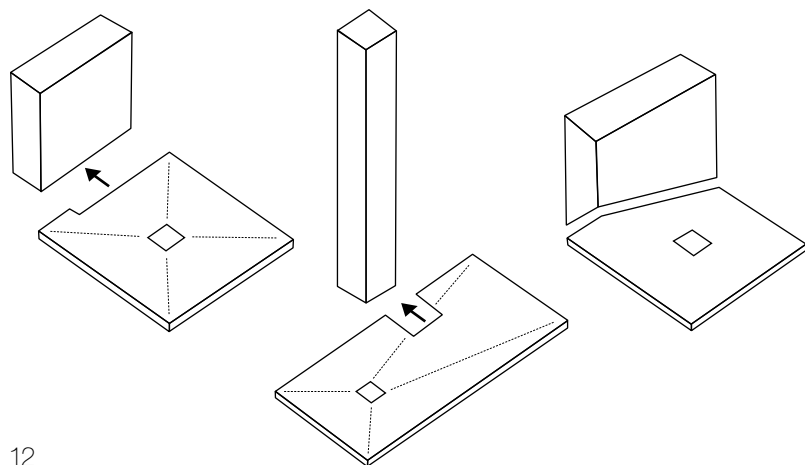

Il Piatto è fornito con piletta diam 90 mm copripiletta in inox a griglia. Imballo singolo, peso 47 kg. al mq.
Taglio a misura passo 5 cm € 85,00 tempi di resa 4 settimane impasto piatto TUTTO COLORE.

*The shower tray is supplied with a 90 mm diameter drain, inox drain hat with grille. One packaging, weight 47 Kilos/sm.
Cutting to size pitch 5 cm. €85,00 - delivery time 4 weeks. Shower tray mixture completely coloured.*

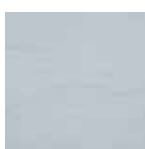
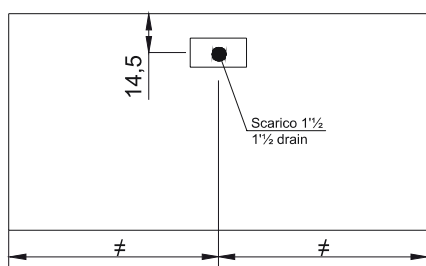

(BI)
Bianco / White

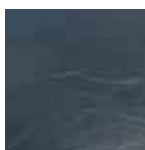

(AN)
Antracite / Anthracite

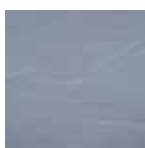

(GR)
Grigio / Grey



(AV)
Avorio / Ivory

FIRENZE

Mineral Marmo e resine, finitura effetto pietra
Profondità 70-80-90 spessore 3,5 cm

Mineral Marble and resins, finishing stone effect,
depth 70-80-90 thickness 3,5 cm

CODICE CODE	DIMENSIONI cm DIMENSIONS cm	PROFILI - PREZZO € PROFILES - PRICE €
		BIANCO (BI) - ANTRACITE (AN) - GRIGIO (GR) - AVORIO (AV) WHITE (BI) - ANTRACITE (AN) - GREY (GR) - IVORY (AV)
FR7 01	70X90	480,00
FR7 02	70X100	535,00
FR7 03	70X120	640,00
FR7 04	70X140	745,00
FR7 05	70X150	800,00

CODICE CODE	DIMENSIONI cm DIMENSIONS cm	PROFILI - PREZZO € PROFILES - PRICE €
		BIANCO (BI) - ANTRACITE (AN) - GRIGIO (GR) - AVORIO (AV) WHITE (BI) - ANTRACITE (AN) - GREY (GR) - IVORY (AV)
FR8 02	80X100	610,00
FR8 03	80X120	735,00
FR8 04	80X140	855,00
FR8 05	80X150	915,00
FR8 06	80X160	975,00
FR8 07	80X170	1040,00
FR8 08	80X180	1100,00

CODICE CODE	DIMENSIONI cm DIMENSIONS cm	PROFILI - PREZZO € PROFILES - PRICE €
		BIANCO (BI) - ANTRACITE (AN) - GRIGIO (GR) - AVORIO (AV) WHITE (BI) - ANTRACITE (AN) - GREY (GR) - IVORY (AV)
FR9 02	90X100	735,00
FR9 03	90X120	860,00
FR9 04	90X140	955,00
FR9 05	90X150	1025,00
FR9 06	90X160	1095,00
FR9 07	90X170	1160,00
FR9 08	90X180	1230,00

Il Piatto è fornito con piletta diam 90 mm copri piletta in resina minerale tinta piatto. Imballo singolo, peso 61 kg. al mq. Taglio a misura passo 5 cm € 85,00 tempi di resa 4 settimane impasto piatto TUTTO COLORE.

The shower tray is supplied with a 90 mm diameter drain, mineral resin drain hat with the same color of shower tray. One packaging, weight 61 Kilos sm. Cutting to size pitch 5 cm. € 85,00 - delivery time 4 weeks. Shower tray mixture completely coloured.

PIATTI DOCCIA

SHOWER TRAYS

I piatti doccia SIENA / FIRENZE sono il risultato di una ricerca continua e di un'esigenza di qualità al massimo livello. Tutti i nostri prodotti sono realizzati a stampo, rispettando le norme antiscivolo-assorbimento-sbalzi termici nonché le norme UNE-EN14257 / UNE-EN251.

DATI TECNICI

I piatti doccia SIENA / FIRENZE sono fabbricati in resina poliestere, la massa è di colore uguale alla finitura dello stesso anche se può avere piccole variazioni. La finitura finale è realizzata in gel coat poliestere di massima qualità che conferisce ai nostri piatti doccia proprietà di durezza, resistenza, durata e impermeabilità. Le griglie dei piatti doccia sono in acciaio inox AISI 316.

INSTALLAZIONE

L'installazione dei nostri piatti doccia è molto importante, deve essere realizzata da personale qualificato e sempre seguendo le istruzioni di installazione che si trovano all'interno della confezione di ogni prodotto.

COLLOCAZIONE DEL PIATTO DOCCIA

1. Preparazione del supporto. La base dove poggia il piatto doccia deve essere perfettamente livellata e asciutta per impedire, con il passare del tempo, al piatto di deformarsi. Il materiale di supporto deve essere ad alta resistenza (cemento, pavimento in grès, ecc.), è necessario lasciare lo spazio per l'impianto idraulico per l'installazione della valvola di scarico.
2. Disimballare il piatto doccia. Aprire l'imballo contenente il piatto doccia avendo cura di non danneggiarne la superficie e capovolgere il cartone per estrarlo. Fare molta attenzione durante queste operazioni per evitare il rischio di danneggiare il piatto doccia o infortuni. Prima di posizionare il piatto, accertarsi che sia in perfetto stato dopodiché occorre lasciarlo "riposare" su una superficie perfettamente piana per un tempo minimo di 20 minuti prima della collocazione.
3. Prima di posare il piatto doccia, applicare una striscia di silicone lungo le pareti e gli angoli contro i quali deve essere installato, per assicurarne la tenuta. Applicare una quantità sufficiente, anche sulla base in modo da assicurare il fissaggio del piatto, vi consigliamo Sikaflex® (adesivo strutturale per applicazioni nautiche).
4. Collocazione del piatto doccia. Posizionare il piatto sulla base, facendo coincidere il foro dello scarico con la valvola installata in precedenza sulla base, poi inserire la piastra decorativa. Proteggere il piatto una volta completato il montaggio. N.B.: prima di piastrellare e posare pareti doccia o qualsiasi altro prodotto sul piatto, verificarne la corretta posa in opera e accertarsi che lo scarico funzioni perfettamente.

TOLLERANZE DIMENSIONALI

A causa delle caratteristiche con cui sono realizzati i piatti doccia, questi hanno una tolleranza di max +/- 5 mm.

CONDIZIONI DI USO E MANTENIMENTO

Per pulire il piatto doccia in profondità, sciacquarlo con acqua e sapone (o altri prodotti non abrasivi usati per pulire il bagno) utilizzando una spugna non abrasiva. Evitare nella pulizia prodotti che contengono acidi e solventi o strumenti abrasivi come carta vetrata, spazzole, ecc., soprattutto nei piatti colorati (ad eccezione del bianco e del crema).

Nel caso siano stati utilizzati prodotti abrasivi (aceto, varechina, viacal, ecc.) sciacquare immediatamente con abbondante acqua e non lasciare i prodotti seccare per un tempo superiore a 2/3 minuti. Eventualmente utilizzare questi prodotti diluiti nell'acqua. **GARANZIA** La garanzia ha durata 2 anni a partire dalla data di fatturazione del prodotto. Il fabbricante copre la riparazione e/o sostituzione dei componenti considerati difettati nel materiale o nel processo di fabbricazione. La garanzia sarà valida solo se accompagnata dalla fattura di acquisto e non copre i danni causati dalla ditta che lo ha trasportato, da un'installazione errata e/o dal mal utilizzo da parte del cliente.

Tutta l'informazione tecnica riportata è puramente orientativa, GIAVA si riserva il diritto di modificare tutto quello che considera opportuno per migliorare il prodotto, sempre che non modifichi le caratteristiche essenziali dello stesso.

SCHEMA TECNICA PIATTI DOCCIA

TECHNICAL SCHEDULE SHOWER TRAYS

SIENA

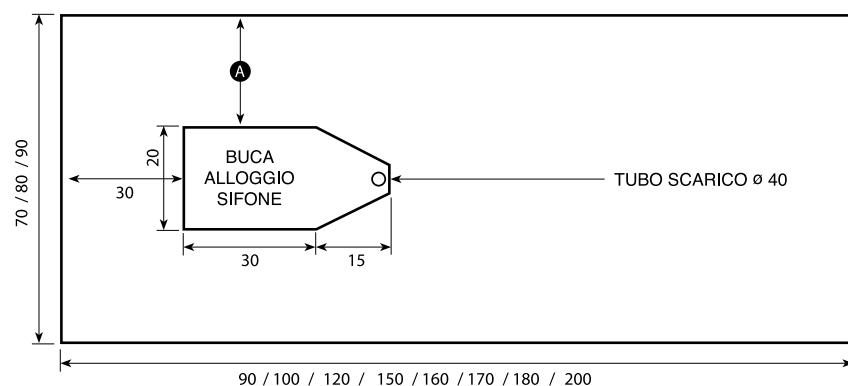

Distanza va iabile per larghezze	70	80	90	100
A	25	30	35	40

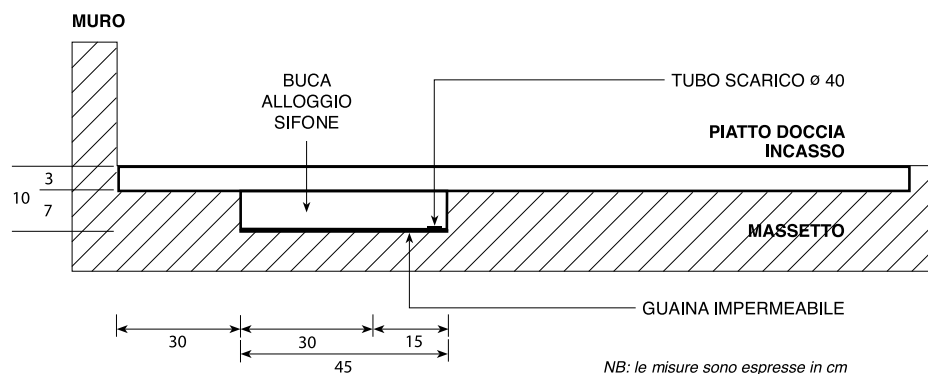
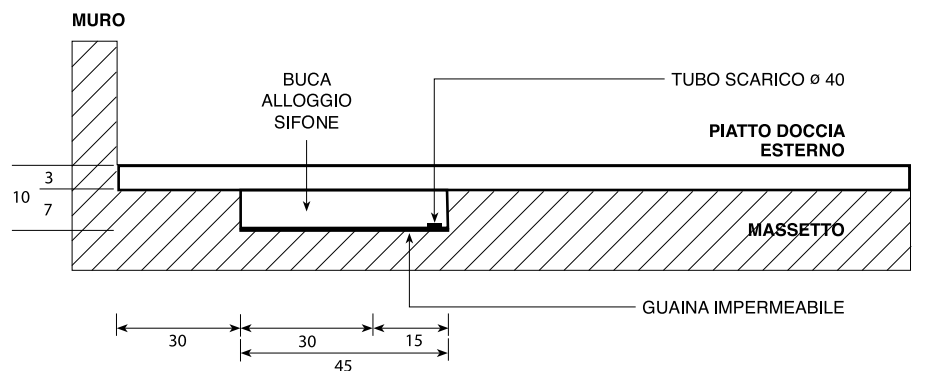

NB: le misure sono espresse in cm

FIRENZE

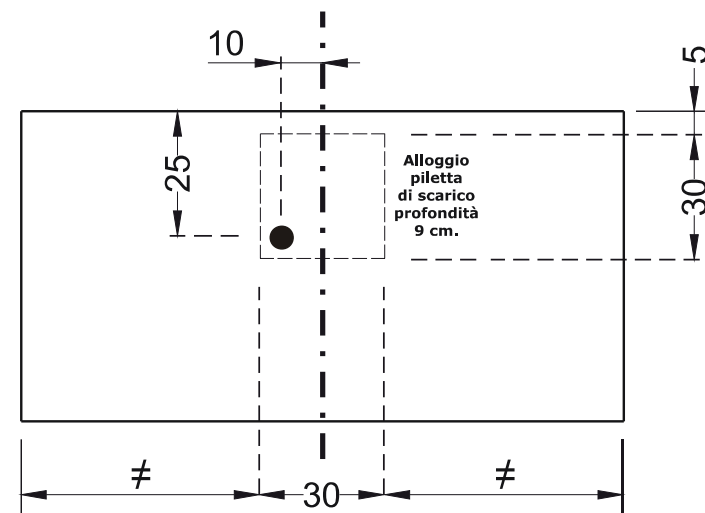
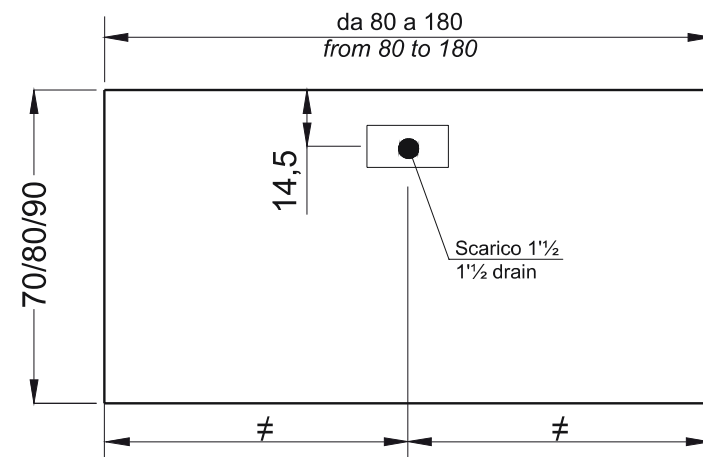

ITACA



- Lato per box angolare a due ante scorrevoli
- Porta ad un'anta scorrevole e una fissa
- Porta a due ante scorrevoli e due fisse
- Porta a due ante a soffietto (con apertura di sicurezza)
- Porta a due ante a saloon
- Parete fissa

- *Side for corner entry shower enclosure two sliding sections*
- *Two-section door, 1 sliding + 1 fixed*
- *Shower enclosure door, 2 sliding + 2 fixed*
- *Folding door (safety opening)*
- *Saloon door*
- *Fixed side panel*











ITACA



CARRELLO DI SCORRIMENTO
A SGANCIO RAPIDO

SLIDING SYSTEM WITH FAST RELEASE



ITA
CA



IP2S15













ITA
CA



ITACA

ITACA

Lato per box angolare a due ante scorrevoli
Side for corner entry shower enclosure two sliding sections

CODICE CODE	ESTENSIBILITÀ cm EXTENSIBILITY cm	APERTURA cm*	FINITURA LASTRA CRISTALLO 6 mm GLASS 6 mm CRYSTAL	PROFILI - PREZZO € PROFILES - PRICE €
				ARGENTO LUCIDO GLOSS 420 (ARGL) SILVER POLISH GLOSS 420 (ARGL)
IA 70	67,5/70	36	T	341,00
IA 75	72,5/75	36	T	341,00
IA 80	77,5/80	43	T	366,00
IA 90	87,5/90	50	T	388,00
IA 100	97,5/100	57	T	420,00
IA 120	117,5/120	71	T	455,00

* Apertura determinata con due lati della stessa misura.

* Opening is calculated with two sides of the same measure

- Scorrimento su cuscinetti a sfera regolabili a sgancio rapido
- Cristallo temperato 6 mm

FINITURA LASTRA

- Trasparente (T)

COLORI PROFILO

- Argento lucido gloss 420 (ARGL)

Abbinabile con il lato fisso IF per trasformarsi in una cabina tre lati

- Sliding on ball bearings fast release
- Tempered glass 6 mm

GLASS

- Clear (T)

TRIM COLORS

- Silver polish gloss 420 (ARGL)

Combinabile con IF fisso side to create a three sections shower cubicle

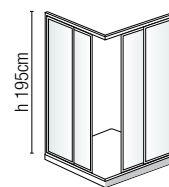

OTTIMO
EXCELLENT



Disponibile su richiesta a € 50,00
Available on request at € 50,00



Dai prezzi sono esclusi: IVA e spese di trasporto. Per articoli su misura considerare i prezzi di listino maggiorati del 40%

Prices do not include: VAT and freight costs.
Custom products +40% on price list.

ITACA

Porta ad un'anta scorrevole e una fissa
Two-section door, 1 sliding + 1 fixed

CODICE CODE	ESTENSIBILITÀ cm EXTENSIBILITY cm	APERTURA cm OPENING cm	FINITURA LASTRA CRISTALLO 6 mm GLASS 6 mm CRYSTAL	PROFILI - PREZZO € PROFILES - PRICE €
				ARGENTO LUCIDO GLOSS 420 (ARGL) SILVER POLISH GLOSS 420 (ARGL)
IPS 05/S	92/97	34	T	547,00
IPS 06	97/102	39	T	547,00
IPS 06/S	102/107	39	T	565,00
IPS 07/S	107/112	44	T	565,00
IPS 10	112/117	44	T	565,00
IPS 07	117/122	49	T	591,00
IPS 08/S	122/127	49	T	591,00
IPS 08	127/132	54	T	617,00
IPS 09/S	132/137	54	T	617,00
IPS 09	137/142	59	T	638,00
IPS 11/S	142/147	59	T	638,00
IPS 12	147/152	64	T	662,00
IPS 12/S	152/157	64	T	662,00
IPS 13	157/162	69	T	674,00
IPS 13/S	167/172	69	T	674,00

new

- Scorrimento su cuscinetti a sfera regolabili a sgancio rapido
- Cristallo temperato 6 mm

FINITURA LASTRA

- Trasparente (T)

COLORI PROFILO

- Argento lucido gloss 420 (ARGL)

Abbinabile con il lato fisso IF per trasformarsi in una cabina a due o tre lati

- Sliding on ball bearings fast release
- Tempered glass 6 mm

GLASS

- Clear (T)

TRIM COLORS

- Silver polish gloss 420 (ARGL)

Combinabile con IF fisso side to create a two or three sections shower cubicle

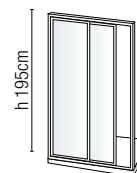

OTTIMO
EXCELLENT



Disponibile su richiesta a € 80,00
Available on request at € 80,00



Dai prezzi sono esclusi: IVA e spese di trasporto. Per articoli su misura considerare i prezzi di listino maggiorati del 40%

Prices do not include: VAT and freight costs.
Custom products +40% on price list.

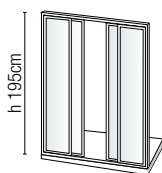

OTTIMO
EXCELLENT



Disponibile
su richiesta
a € 100,00
Available
on request
at € 100,00

- Scorrimento su cuscinetti a sfera regolabili a sgancio rapido
- Cristallo temperato 6 mm

FINITURA LASTRA

- Trasparente (T)

COLORI PROFILO

- Argento lucido gloss 420 (ARGL)

Abbinabile con il lato fisso IF per trasformarsi in una cabina a due o tre lati

- Sliding on ball bearings fast release
- Tempered glass 6 mm

GLASS

- Clear (T)

TRIM COLORS

- Silver polish gloss 420 (ARGL)

Combinable with IF fixed side to create a two or three sections shower cubicle

ITACA

Porta due ante scorrevoli e due fisse
Shower enclosure door, 2 sliding + 2 fixed

CODICE CODE	ESTENSIBILITÀ cm EXTENSIBILITY cm	APERTURA cm OPENING cm	FINITURA LASTRA CRISTALLO 6 mm GLASS 6 mm CRYSTAL	PROFILI - PREZZO € PROFILES - PRICE €
				ARGENTO LUCIDO GLOSS 420 (ARGL) SILVER POLISH GLOSS 420 (ARGL)
IP2S 14	137/142	56	T	768,00
IP2S 14/S	142/147	56	T	768,00
IP2S 15	147/152	61	T	768,00
IP2S 16	152/157	61	T	875,00
IP2S 17	157/162	66	T	875,00
IP2S 18	162/167	66	T	875,00
IP2S 19	167/172	81	T	922,00
IP2S 20	172/177	81	T	922,00
IP2S 21	177/182	86	T	922,00
IP2S 22	182/187	86	T	922,00
IP2S 23	187/192	86	T	1080,00
IP2S 24	192/197	86	T	1080,00

Dai prezzi sono esclusi: IVA e spese di trasporto.
Per articoli su misura considerare i prezzi di listino maggiorati del 40%

Prices do not include: VAT and freight costs.
Custom products +40% on price list.

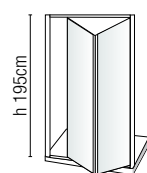
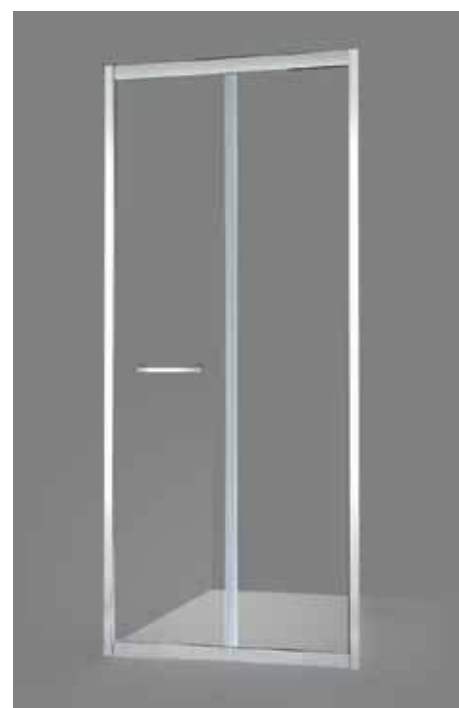

OTTIMO
EXCELLENT



Disponibile
su richiesta
a € 80,00
Available
on request
at € 80,00

- Sistema apertura esterna antipanico
- Cristallo temperato 6 mm

FINITURA LASTRA

- Trasparente (T)

COLORI PROFILO

- Argento lucido gloss 420 (ARGL)

Abbinabile con il lato fisso IF per trasformarsi in una cabina a due o tre lati

- Safety opening system
- Tempered glass 6 mm

GLASS

- Clear (T)

TRIM COLORS

- Silver polish gloss 420 (ARGL)

Combinable with IF fixed side to create a two or three sections shower cubicle

new

ITACA

Porta a due ante a soffietto
(con apertura di sicurezza)
Folding door (safety opening)

CODICE CODE	ESTENSIBILITÀ cm EXTENSIBILITY cm	APERTURA cm OPENING cm	FINITURA LASTRA CRISTALLO 6 mm GLASS 6 mm CRYSTAL	PROFILI - PREZZO € PROFILES - PRICE €
				ARGENTO LUCIDO GLOSS 420 (ARGL) SILVER POLISH GLOSS 420 (ARGL)
ISS 01	63/68	39	T	565,00
ISS 02	68/73	44	T	565,00
ISS 03	73/78	49	T	585,00
ISS 04	78/83	54	T	585,00
ISS 05	83/88	59	T	605,00
ISS 06	88/93	64	T	605,00
ISS 07	93/98	69	T	625,00
ISS 08	98/103	74	T	645,00
ISS 09	103/108	79	T	665,00

Dai prezzi sono esclusi: IVA e spese di trasporto.
Per articoli su misura considerare i prezzi di listino maggiorati del 40%

Prices do not include: VAT and freight costs.
Custom products +40% on price list.

ITACA new

Porta a due ante a saloon Saloon door

CODICE CODE	ESTENSIBILITÀ cm EXTENSIBILITY cm	APERTURA cm* OPENING cm	FINITURA LASTRA CRISTALLO 6 mm GLASS 6 mm CRYSTAL	PROFILI - PREZZO € PROFILES - PRICE €
				ARGENTO LUCIDO GLOSS 420 (ARGL) SILVER POLISH GLOSS 420 (ARGL)
I2S 01	73/78	52	T	565,00
I2S 02	78/83	57	T	565,00
I2S 03	83/88	62	T	580,00
I2S 04	88/93	67	T	580,00
I2S 05	93/98	72	T	595,00
I2S 06	98/102	77	T	595,00

· Cristallo temperato 6 mm

FINITURA LASTRA

• Trasparente (T)

COLORI PROFILO

• Argento lucido
gloss 420 (ARGL)

Abbinabile con il lato fisso IF
per trasformarsi in una cabina
a due o tre lati

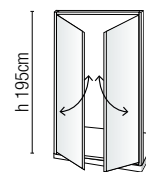

OTTIMO
EXCELLENT



· Tempered glass 6 mm

GLASS

• Clear (T)

TRIM COLORS

• Silver polish gloss 420 (ARGL)



Combinabile with IF fixed side to create a
two or three sections shower cubicle



Disponibile
su richiesta
a € 75,00
Available
on request
at € 75,00

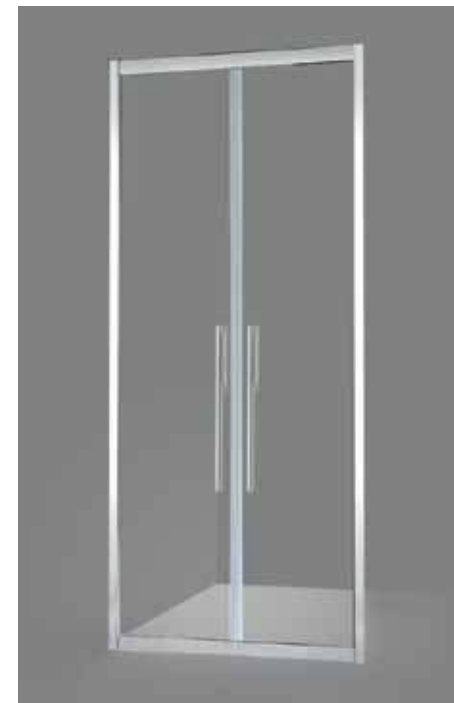

Dai prezzi sono esclusi: IVA e spese di trasporto. Per articoli su
misura considerare i prezzi di listino maggiorati del 40%

Prices do not include: VAT and freight costs.
Custom products +40% on price list.

ITACA

Parete fissa Fixed side panel

CODICE CODE	ESTENSIBILITÀ cm EXTENSIBILITY cm	FINITURA LASTRA CRISTALLO 6 mm GLASS 6 mm CRYSTAL	PROFILI - PREZZO € PROFILES - PRICE €
			ARGENTO LUCIDO GLOSS 420 (ARGL) SILVER POLISH GLOSS 420 (ARGL)
IF 03	67,5/69,5	T	355,00
IF 04	70,5/72,5	T	355,00
IF 05	72,5/74,5	T	355,00
IF 06	77,5/79,5	T	365,00
IF 07	87,5/89,5	T	365,00
IF 08	97,5/99,5	T	375,00

· Parete fissa per Itaca
IA - IPS - IP2S - ISS - I2S
· Cristallo temperato 6 mm

FINITURA LASTRA

• Trasparente (T)

COLORI PROFILO

• Argento lucido
gloss 420 (ARGL)

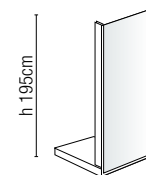

OTTIMO
EXCELLENT



· Fixed panel
for Tonga IA - IPS - IP2S - ISS - I2S
· Tempered glass 6 mm

GLASS

• Clear (T)

TRIM COLORS

• Silver polish gloss 420 (ARGL)



Disponibile
su richiesta
a € 60,00
Available
on request
at € 60,00



Dai prezzi sono esclusi: IVA e spese di trasporto. Per articoli su
misura considerare i prezzi di listino maggiorati del 40%

Prices do not include: VAT and freight costs.
Custom products +40% on price list.

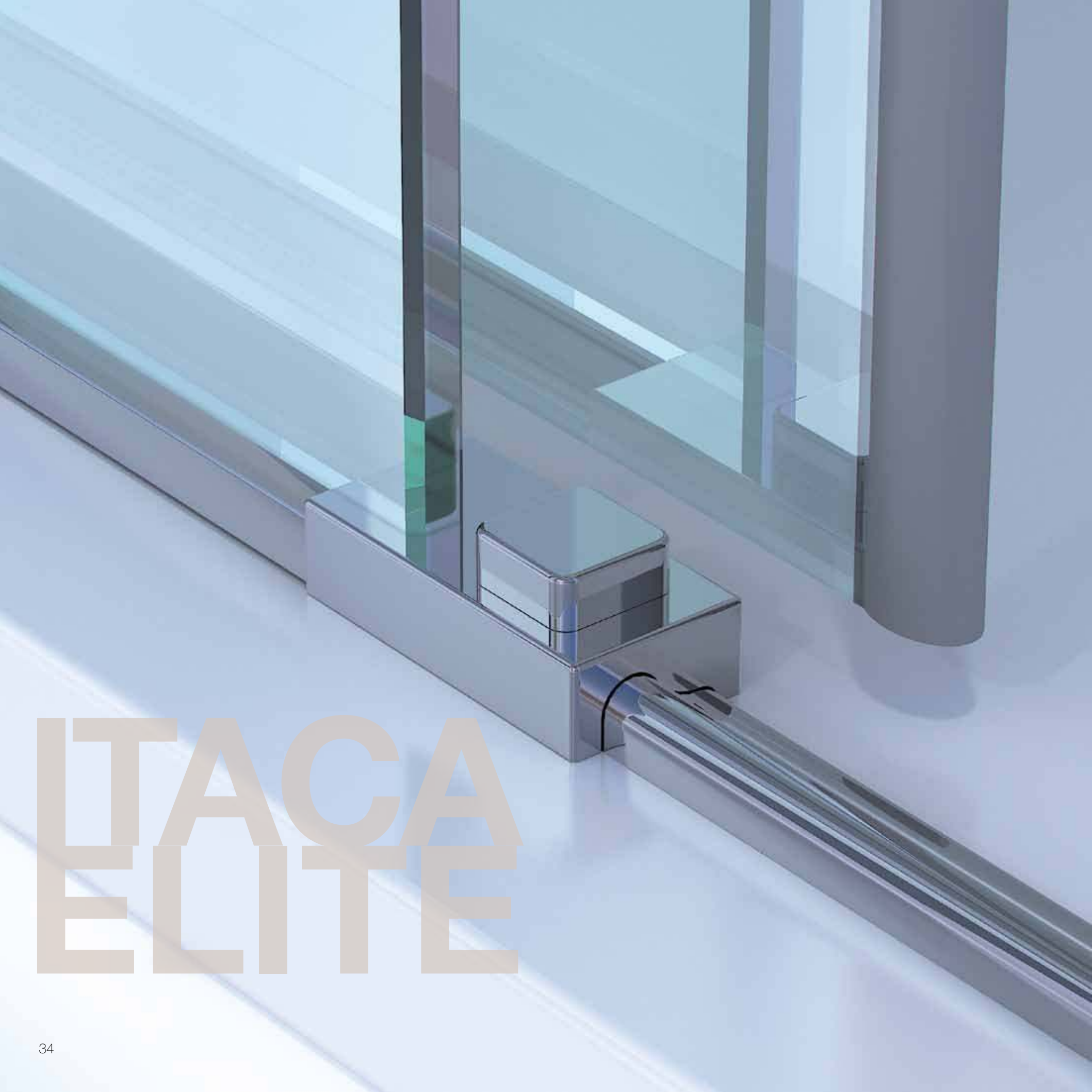

ITACA ELITE

- Lato per box angolare a due ante scorrevoli
 - Porta ad un'anta scorrevole e una fissa
 - Parete fissa
-
- *Side for corner entry shower enclosure two sliding sections*
 - *Two-section door, 1 sliding + 1 fixed*
 - *Fixed side panel*

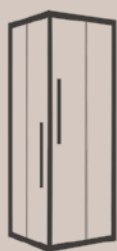



ITACA ELITE



IAE70/90

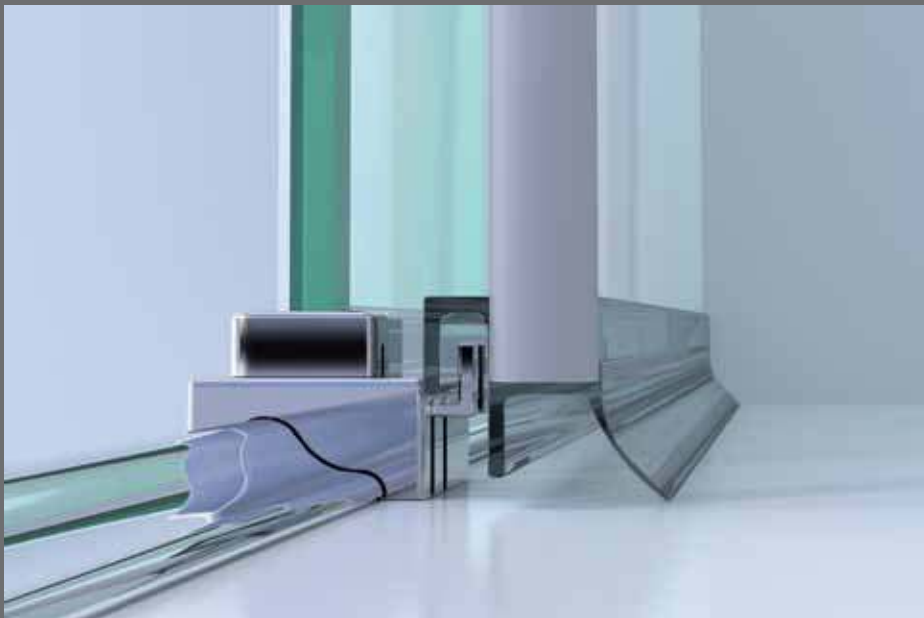







ITACA
ELITE

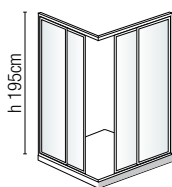

OTTIMO
EXCELLENT



Di serie,
compreso
nel prezzo
Standard,
including
in the price

- Scorrimento superiore su cuscinetti a sfera regolabili
- Sgancio rapido ante
- Cristallo temperato 6 mm

FINITURA LASTRA

- Trasparente (T)

COLORI PROFILO

- Argento lucido gloss 420 (ARGL)

- Sliding on ball bearings
- Fast release
- Tempered glass 6 mm

GLASS

- Clear (T)

TRIM COLORS

- Silver polish gloss 420 (ARGL)

- Sliding on ball bearings fast release
- Tempered glass 6 mm

GLASS

- Clear (T)

TRIM COLORS

- Silver polish gloss 420 (ARGL)

Combinabile with IF fixed side to create a three sections shower cubicle

Dai prezzi sono esclusi: IVA e spese di trasporto. Per articoli su misura considerare i prezzi di listino maggiorati del 40%

Prices do not include: VAT and freight costs.
Custom products +40% on price list.

ITACA ELITE

Lato per box angolare a due ante scorrevoli
Side for corner entry shower enclosure two sliding sections

CODICE CODE	ESTENSIBILITÀ cm EXTENSIBILITY cm	APERTURA cm* OPENING cm	FINITURA LASTRA CRISTALLO 6 mm GLASS 6 mm CRYSTAL	PROFILI - PREZZO € PROFILES - PRICE €
				ARGENTO LUCIDO GLOSS 420 (ARGL) SILVER POLISH GLOSS 420 (ARGL)
IAE 70	67,5/69,5	35	T	430,00
IAE 75	72,5/74,5	35	T	430,00
IAE 80	77,5/79,5	42	T	460,00
IAE 90	87,5/89,5	49	T	480,00
IAE 100	97,5/99,5	56	T	502,00
IAE 120	117,5/119,5	70	T	532,00

* Apertura determinata con due lati della stessa misura.

* Opening is calculated with two sides of the same measure

Versione SX

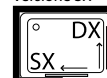

Versione DX



Per piatto doccia rettangolare
indicare se il lato lungo va a sx o a dx
In case of rectangular shower tray indicate
if the long side is on the left or on the right

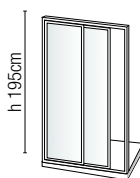

OTTIMO
EXCELLENT



Di serie,
compreso
nel prezzo
Standard,
including
in the price

- Scorrimento superiore su cuscinetti a sfera regolabili
- Sgancio rapido ante
- Cristallo temperato 6 mm

FINITURA LASTRA

- Trasparente (T)

COLORI PROFILO

- Argento lucido gloss 420 (ARGL)

Abbinabile con il lato fisso IFE
per trasformarsi in una cabina
a due lati

- Sliding on ball bearings
- Fast release
- Tempered glass 6 mm

GLASS

- Clear (T)

TRIM COLORS

- Silver polish gloss 420 (ARGL)

Combinabile with IF fixed side to create a three sections shower cubicle

Dai prezzi sono esclusi: IVA e spese di trasporto. Per articoli su misura considerare i prezzi di listino maggiorati del 40%

Prices do not include: VAT and freight costs.
Custom products +40% on price list.

ITACA ELITE

Porta ad un'anta scorrevole e una fissa
Two-section door, 1 sliding + 1 fixed

CODICE CODE	ESTENSIBILITÀ cm EXTENSIBILITY cm	APERTURA cm OPENING cm	FINITURA LASTRA CRISTALLO 6 mm GLASS 6 mm CRYSTAL	PROFILI - PREZZO € PROFILES - PRICE €
				ARGENTO LUCIDO GLOSS 420 (ARGL) SILVER POLISH GLOSS 420 (ARGL)
IPSE 06	97/100	39	T	635,00
IPSE 07/S	107/110,5	39	T	652,00
IPSE 07	117/120,5	49	T	678,00
IPSE 08	127/130,5	59	T	705,00
IPSE 09	137/140,5	68	T	725,00
IPSE 10	147/150,5	68	T	757,00
IPSE 11	157/160,5	70	T	770,00
IPSE 12	167/170,5	75	T	798,00

Versione SX



Versione sx con parete
fissa laterale dx

Left version with a fixed
panel on the right side

Versione DX



Versione dx con parete
fissa laterale sx

Right version with a fixed
panel on the left side

ITACA ELITE

Parete fissa
Fixed side panel

CODICE CODE	ESTENSIBILITÀ cm EXTENSIBILITY cm	FINITURA LASTRA CRISTALLO 6 mm GLASS 6 mm CRYSTAL	PROFILI - PREZZO € PROFILES - PRICE €
			ARGENTO LUCIDO GLOSS 420 (ARGL) SILVER POLISH GLOSS 420 (ARGL)
IFE 03	67,5/69,5	T	360,00
IFE 04	70,5/72,5	T	360,00
IFE 05	72,5/74,5	T	360,00
IFE 06	77,5/79,5	T	371,00
IFE 07	87,5/89,5	T	371,00
IFE 08	97,5/99,5	T	385,00

Versione DX



Versione SX



- Parete fissa per Itaca Elite IPSE
- Cristallo temperato 6 mm

FINITURA LASTRA

- Trasparente (T)

COLORI PROFILO

- Argento lucido
gloss 420 (ARGL)

- Fixed panel for Itaca Elite IPSE
- Tempered glass 6 mm

GLASS

- Clear (T)

TRIM COLORS

- Silver polish gloss 420 (ARGL)

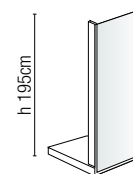

OTTIMO
EXCELLENT



Di serie,
compreso
nel prezzo
Standard,
including
in the price



Dai prezzi sono esclusi: IVA e spese di trasporto.
Per articoli su misura considerare i prezzi di listino maggiorati del 40%

Prices do not include: VAT and transport costs.
For custom orders considering the list prices increased by +40%

FIJI

A photograph of a modern bathroom interior. The scene is dominated by a glass shower enclosure with a wooden-look floor. Sunlight streams in from a window with vertical blinds, casting long, soft shadows across the floor. The overall aesthetic is clean, minimalist, and bright.

- Parete frontale
- Parete frontale da abbinare con due laterali
(comporre con art. FILAF)
- Parete frontale con fissaggio a muro
(comporre con art. FIFM)
- Parete frontale da abbinare al lato fisso
a muro e al laterale fisso (comporre con art. FIFM-FILAF)
- Parete frontale da abbinare al lato fisso a muro
(comporre con art. FIFM)
- Parete frontale con fissaggio a muro da
abbinare al laterale fisso (comporre con art. FILAF)
- Parete frontale con fissaggio a muro da
abbinare al laterale fisso e al lato fisso separato
(comporre con art. FILAF-FIFM)
- Laterale fisso
- Lato fisso a muro

- *Freestanding walk-in*
- *Freestanding walk-in combine with FILAF panels*
- *Free standing side panel*
- *Freestanding walk-in (combine with freestanding side panel
FIFM + FILAF)*
- *Freestanding walk-in (combine with freestanding side panel
FIFM)*
- *Freestanding side panel (combine with FILAF)*
- *Double freestanding side panel (combine with FILAF + FIFM)*
- *FILAF*
- *Fixed side panel*





FIJI







FIJI



FIL 04

FIJI

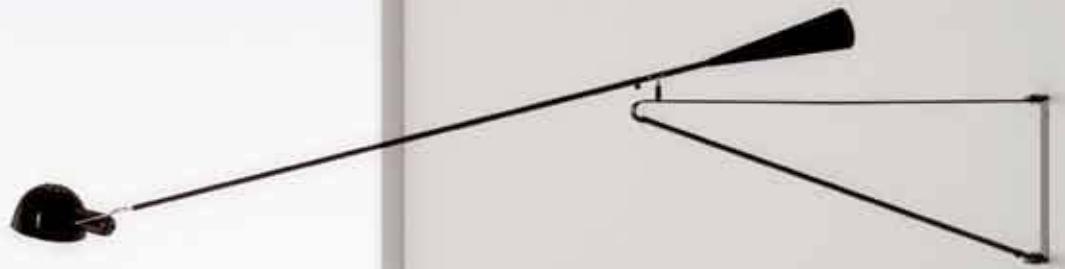



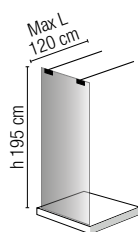

· Cristallo temperato 8 mm

FINITURA LASTRA

- Trasparente (T)
- Grey (GY)
- Serigrafato (S3)
- Specchio trasparente (ST)
- Specchio grey (SGY)

COLORI PROFILO

- Cromo lucido (CR)
- Barre di sostegno cromo

N° 2 barre di sostegno cm 120 comprese nel prezzo



MEDIO
MIDDLE



· Tempered 8 mm crystal

GLASS

- Clear (T)
- Grey (GY)
- Silk-screen (S3)
- Transparent Mirror (ST)
- Grey mirror (SGY)

TRIM COLORS

- Bright chrome (CR)
- Support chromed bars

N° 2 support bars cm 120 included in the price



Di serie,
compreso
nel prezzo
Standard,
including
in the price

FIJI

Parete frontale Freestanding walk-in

CODICE CODE	ESTENSIBILITÀ cm EXTENSIBILITY cm	FINITURA LASTRA CRISTALLO 8 mm	PROFILI - PREZZO € PROFILES - PRICE €
		GLASS 8 MM CRYSTAL	CROMO LUCIDO (CR) BRIGHT CHROME (CR)
FI 01	117	T	700,00
		GY	832,00
		ST	915,00
		SGY	1068,00
		S3	775,00
FI 02	137	T	700,00
		GY	832,00
		ST	915,00
		SGY	1068,00
		S3	775,00
FI 03	147	T	821,00
		GY	963,00
		ST	1080,00
		SGY	1240,00
		S3	-
FI 04	157	T	821,00
		GY	963,00
		ST	1080,00
		SGY	1240,00
		S3	-
FI 05	167	T	889,00
		GY	1031,00
		ST	1210,00
		SGY	1367,00
		S3	-

Dai prezzi sono esclusi: IVA e spese di trasporto. Per articoli su misura considerare i prezzi di listino maggiorati del 40%

Prices do not include: VAT and freight costs.
Custom products +40% on price list.

FIJI

Parete frontale da abbinare con due laterali (comporre con art. FILAF)

Freestanding walk-in combine with FILAF panels

CODICE CODE	ESTENSIBILITÀ cm EXTENSIBILITY cm	LATERALE FISSO ABBINABILE FIXED LATERAL TO COUPLE	FINITURA LASTRA CRISTALLO 8 mm	PROFILI - PREZZO € PROFILES - PRICE €
			GLASS 8 MM CRYSTAL	CROMO LUCIDO (CR) BRIGHT CHROME (CR)
FI2F 01	117,5		T	752,00
			GY	905,00
			ST	968,00
			SGY	1140,00
			S3	854,00
FI2F 02	137,5		T	752,00
			GY	905,00
			ST	968,00
			SGY	1140,00
			S3	854,00
FI2F 03	147,5	FILAF 01-02-03	T	884,00
			GY	1037,00
			ST	1144,00
			SGY	1314,00
			S3	-
FI2F 04	157,5		T	884,00
			GY	1037,00
			ST	1144,00
			SGY	1314,00
			S3	-
FI2F 05	167,5		T	947,00
			GY	1111,00
			ST	1268,00
			SGY	1446,00
			S3	-

· Cristallo temperato
8 mm / 6 mm

FINITURA LASTRA

- Trasparente (T)
- Grey (GY)
- Serigrafato (S3)
- Specchio trasparente (ST)
- Specchio grey (SGY)

COLORI PROFILO

- Cromo lucido (CR)
- Barre di sostegno cromo

N° 2 barre di sostegno cm 120 comprese nel prezzo

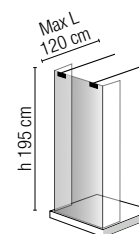

MEDIO
MIDDLE



· Tempered 8 mm / 6 mm crystal

GLASS

- Clear (T)
- Grey (GY)
- Silk-screen (S3)
- Transparent Mirror (ST)
- Grey mirror (SGY)

TRIM COLORS

- Bright chrome (CR)
- Support chromed bars

N° 2 support bars cm 120 included in the price



Di serie,
compreso
nel prezzo
Standard,
including
in the price



Dai prezzi sono esclusi: IVA e spese di trasporto. Per articoli su misura considerare i prezzi di listino maggiorati del 40%
Prices do not include: VAT and freight costs.
Custom products +40% on price list.

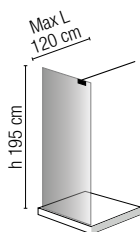

- Cristallo temperato 8 mm / 6 mm
- FINITURA LASTRA**
- Trasparente (T)
 - Grey (GY)
 - Serigrafato (S3)
 - Specchio trasparente (ST)
 - Specchio grey (SGY)

COLORI PROFILO

- Cromo lucido (CR)
- Barre di sostegno cromo

N° 1 barra di sostegno cm 120 compresa nel prezzo



MEDIO
MIDDLE



• Tempered 8 mm / 6 mm crystal

GLASS

- Clear (T)
- Grey (GY)
- Silk-screen (S3)
- Transparent Mirror (ST)
- Grey mirror (SGY)

TRIM COLORS

- Bright chrome (CR)
- Support chromed bars

N° 1 support bar cm 120 included in the price



Di serie,
compreso
nel prezzo
Standard,
including
in the price

Dai prezzi sono esclusi: IVA e spese di trasporto. Per articoli su misura considerare i prezzi di listino maggiorati del 40%

Prices do not include: VAT and freight costs.
Custom products +40% on price list.

CODICE CODE	ESTENSIBILITÀ cm EXTENSIBILITY cm	FINITURA LASTRA CRISTALLO 8 mm	PROFILI - PREZZO € PROFILES - PRICE €
		GLASS 8 MM CRYSTAL	CROMO LUCIDO (CR) BRIGHT CHROME (CR)
FIM 01	117,5/118,5	T	659,00
		GY	786,00
		ST	874,00
		SGY	1022,00
		S3	729,00
FIM 02	137,5/138,5	T	659,00
		GY	786,00
		ST	874,00
		SGY	1022,00
		S3	729,00
FIM 03	147,5/148,5	T	775,00
		GY	906,00
		ST	1035,00
		SGY	1193,00
		S3	-
FIM 04	157,5/158,5	T	775,00
		GY	906,00
		ST	1035,00
		SGY	1193,00
		S3	-
FIM 05	167,5/168,5	T	865,00
		GY	1002,00
		ST	1152,00
		SGY	1303,00
		S3	-

FIJI

Parete frontale con fissaggio a muro
Free standing side panel

CODICE CODE	ESTENSIBILITÀ cm EXTENSIBILITY cm	FINITURA LASTRA CRISTALLO 6 mm	PROFILI - PREZZO € PROFILES - PRICE €
		GLASS 6 MM CRYSTAL	CROMO LUCIDO (CR) BRIGHT CHROME (CR)
FIM 10	66/67	T	400,00
		GY	447,00
		ST	503,00
		SGY	532,00
		S3	-
FIM 11	72/73	T	400,00
		GY	447,00
		ST	503,00
		SGY	532,00
		S3	-
FIM 12	77/78	T	451,00
		GY	496,00
		ST	574,00
		SGY	605,00
		S3	-
FIM 13	87/88	T	451,00
		GY	496,00
		ST	574,00
		SGY	605,00
		S3	-
FIM 14	97/98	T	472,00
		GY	516,00
		ST	635,00
		SGY	678,00
		S3	-
FIM 15	107/108	T	472,00
		GY	516,00
		ST	635,00
		SGY	678,00
		S3	-
FIM 16	117/118	T	500,00
		GY	545,00
		ST	663,00
		SGY	707,00
S3	-		

FIJI

Parete frontale da abbinare al lato fisso a muro e al laterale fisso (comporre con art. FIFM-FILAF)

Freestanding walk-in (combine with freestanding side panel FIFM + FILAF)

CODICE CODE	ESTENSIBILITÀ cm EXTENSIBILITY cm	LATO FISSO A MURO + LATERALE FISSO ABBINABILE WALL FIXED SIDE + FIXED LATERAL TO COUPLE	FINITURA LASTRA CRISTALLO 8 mm GLASS 8 MM CRYSTAL	PROFILI - PREZZO € PROFILES - PRICE €
				CROMO LUCIDO (CR) BRIGHT CHROME (CR)
FILF 01	117,5		T	752,00
			GY	905,00
			ST	968,00
			SGY	1140,00
			S3	854,00
FILF 02	137,5		T	752,00
			GY	905,00
			ST	968,00
			SGY	1140,00
			S3	854,00
FILF 03	147,5	FIFM 01-02-03-04/ FILAF 01-02-03	T	884,00
			GY	1037,00
			ST	1144,00
			SGY	1314,00
			S3	-
FILF 04	157,5		T	884,00
			GY	1037,00
			ST	1144,00
			SGY	1314,00
			S3	-
FILF 05	167,5		T	947,00
			GY	1111,00
			ST	1268,00
			SGY	1446,00
			S3	-

· Cristallo temperato 8 mm / 6 mm

FINITURA LASTRA

- Trasparente (T)
- Grey (GY)
- Serigrafato (S3)
- Specchio trasparente (ST)
- Specchio grey (SGY)

COLORI PROFILO

- Cromo lucido (CR)
- Barra di sostegno cromo

N° 1 barra di sostegno cm 120 compresa nel prezzo

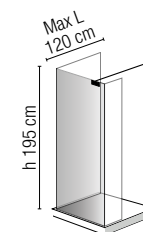

MEDIO MIDDLE



· Tempered 8 mm / 6 mm crystal

GLASS

- Clear (T)
- Grey (GY)
- Silk-screen (S3)
- Transparent Mirror (ST)
- Grey mirror (SGY)

TRIM COLORS

- Bright chrome (CR)
- Support chromed bar

N° 1 support bar cm 120 included in the price



Di serie, compreso nel prezzo Standard, including in the price



Dai prezzi sono esclusi: IVA e spese di trasporto. Per articoli su misura considerare i prezzi di listino maggiorati del 40%
Prices do not include: VAT and freight costs.
Custom products +40% on price list.

FIJI

Parete frontale da abbinare al lato fisso a muro (comporre con art. FIFM)

Freestanding walk-in (combine with freestanding side panel FIFM)

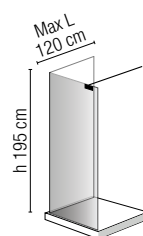

· Cristallo temperato 8 mm / 6 mm

FINITURA LASTRA

- Trasparente (T)
- Grey (GY)
- Serigrafato (S3)
- Specchio trasparente (ST)
- Specchio grey (SGY)

COLORI PROFILO

- Cromo lucido (CR)
- Barra di sostegno cromo

N° 1 barra di sostegno cm 120 compresa nel prezzo



MEDIO MIDDLE



· Tempered 8 mm / 6 mm crystal

GLASS

- Clear (T)
- Grey (GY)
- Silk-screen (S3)
- Transparent Mirror (ST)
- Grey mirror (SGY)

TRIM COLORS

- Bright chrome (CR)
- Support chromed bar

N° 1 support bar cm 120 included in the price



Di serie, compreso nel prezzo Standard, including in the price

CODICE CODE	ESTENSIBILITÀ cm EXTENSIBILITY cm	LATO FISSO A MURO WALL FIXED SIDE	FINITURA LASTRA CRISTALLO 8 mm GLASS 8 MM CRYSTAL	PROFILI - PREZZO € PROFILES - PRICE €
				CROMO LUCIDO (CR) BRIGHT CHROME (CR)
FIL 01	117,3		T	724,00
			GY	865,00
			ST	939,00
			SGY	1100,00
			S3	802,00
FIL 02	137,3		T	724,00
			GY	865,00
			ST	939,00
			SGY	1100,00
			S3	802,00
FIL 03	147,3	FIFM 01-02-03-04	T	852,00
			GY	996,00
			ST	1112,00
			SGY	1273,00
			S3	-
FIL 04	157,3		T	852,00
			GY	996,00
			ST	1112,00
			SGY	1273,00
			S3	-
FIL 05	167,3		T	915,00
			GY	1070,00
			ST	1196,00
			SGY	1369,00
			S3	-

Dai prezzi sono esclusi: IVA e spese di trasporto. Per articoli su misura considerare i prezzi di listino maggiorati del 40%
Prices do not include: VAT and freight costs.
Custom products +40% on price list.

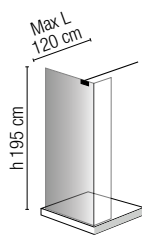

MEDIO
MIDDLE



Di serie,
compreso
nel prezzo
Standard,
including
in the price

- Cristallo temperato
8 mm / 6 mm

FINITURA LASTRA

- Trasparente (T)
- Grey (GY)
- Serigrafato (S3)
- Specchio trasparente (ST)
- Specchio grey (SGY)

COLORI PROFILO

- Cromo lucido (CR)
- Barra di sostegno cromo

N° 1 barra di sostegno cm 120
compresa nel prezzo

- Tempered 8 mm / 6 mm crystal

GLASS

- Clear (T)
- Grey (GY)
- Silk-screen (S3)
- Transparent Mirror (ST)
- Grey mirror (SGY)

TRIM COLORS

- Bright chrome (CR)
- Support chromed bar

N° 1 support bar cm 120 included in
the price

Dai prezzi sono esclusi: IVA e spese di trasporto. Per articoli su misura considerare i prezzi di listino maggiorati del 40%

Prices do not include: VAT and freight costs.
Custom products +40% on price list.

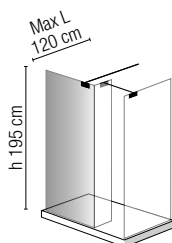

MEDIO
MIDDLE



Di serie,
compreso
nel prezzo
Standard,
including
in the price

- Cristallo temperato
8 mm / 6 mm

FINITURA LASTRA

- Trasparente (T)
- Grey (GY)
- Serigrafato (S3)
- Specchio trasparente (ST)
- Specchio grey (SGY)

COLORI PROFILO

- Cromo lucido (CR)
- Barre di sostegno cromo

N° 1 barra di sostegno cm 120
comprese nel prezzo

N° 1 barra di vetro-vetro cm 90
compresa nel prezzo

- Tempered 8 mm / 6 mm crystal

GLASS

- Clear (T)
- Grey (GY)
- Silk-screen (S3)
- Transparent Mirror (ST)
- Grey mirror (SGY)

TRIM COLORS

- Bright chrome (CR)
- Support chromed bar

N° 1 support bar cm 120 included in
the price

N° 1 glass-glass bar cm 90 included
in the price

A richiesta porta-salviette L 42 CM € 75,00

On demand towel holder L 42 CM € 75,00

Dai prezzi sono esclusi: IVA e spese di trasporto. Per articoli su misura considerare i prezzi di listino maggiorati del 40%

Prices do not include: VAT and freight costs.
Custom products +40% on price list.

FIJI

Parete frontale con fissaggio a muro
da abbinare al laterale fisso
(comporre con art. FILAF)

Freestanding side panel (combine with FILAF)

CODICE CODE	ESTENSIBILITÀ cm EXTENSIBILITY cm	LATERALE FISSO ABBINABILE FIXED SIDE WITH	FINITURA LASTRA CRISTALLO 8 mm GLASS 8 MM CRYSTAL	PROFILI - PREZZO € PROFILES - PRICE €
				CROMO LUCIDO (CR) BRIGHT CHROME (CR)
FIMF 01	117,5/118,5		T	687,00
			GY	818,00
			ST	847,00
			SGY	980,00
			S3	760,00
FIMF 02	137,5/138,5		T	687,00
			GY	818,00
			ST	847,00
			SGY	980,00
			S3	760,00
FIMF 03	147,5/148,5	FILAF 01-02-03	T	801,00
			GY	940,00
			ST	963,00
			SGY	1102,00
			S3	-
FIMF 04	157,5/158,5		T	801,00
			GY	940,00
			ST	963,00
			SGY	1102,00
			S3	-
FIMF 05	167,5/168,5		T	882,00
			GY	1021,00
			ST	1034,00
			SGY	1173,00
			S3	-

FIJI

Parete frontale con fissaggio a muro
da abbinare al laterale fisso e al lato fisso
separato (comporre con art. FILAF-FIFM)

Double freestanding side panel
(combine with FILAF + FIFM)

CODICE CODE	ESTENSIBILITÀ cm EXTENSIBILITY cm	LATO FISSO A MURO + LATERALE FISSO ABBINABILE WALL FIXED SIDE + COMBINABLE FIXED SIDE	FINITURA LASTRA CRISTALLO 8 / 6 mm GLASS 8 / 6 mm CRYSTAL	PROFILI - PREZZO € PROFILES - PRICE €
				CROMO LUCIDO (CR) BRIGHT CHROME (CR)
FIMFL 01	86/88	FILAF 01-02-03 / FIFM 01-02-03-04	T	520,00
			GY	656,00
			ST	682,00
			SGY	818,00
			S3	-
FIMFL 02	104/106		T	627,00
			GY	764,00
			ST	789,00
			SGY	925,00
			S3	-

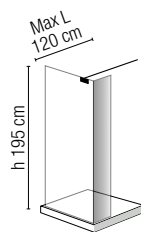
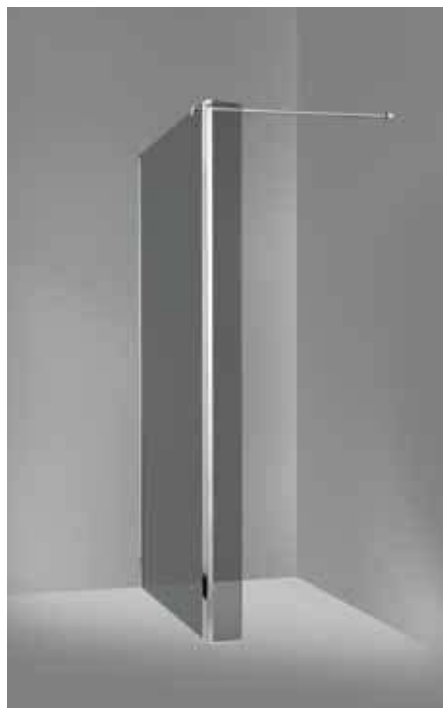

· Cristallo temperato 6 mm

FINITURA LASTRA

- Trasparente (T)
- Grey (GY)
- Serigrafato (S3)
- Specchio trasparente (ST)
- Specchio grey (SGY)

COLORI PROFILO

- Cromo lucido (CR)



MEDIO
MIDDLE



Di serie,
compreso
nel prezzo
Standard,
including
in the price

· Tempered 6 mm crystal

GLASS

- Clear (T)
- Grey (GY)
- Silk-screen (S3)
- Transparent Mirror (ST)
- Grey mirror (SGY)

TRIM COLORS

- Bright chrome (CR)

FIJI

Laterale fisso

FILAF

CODICE CODE	ESTENSIBILITÀ cm EXTENSIBILITY cm	DA ABBINARE CON TO COMBINE WITH	FINITURA LASTRA CRISTALLO 6 mm GLASS 6 mm CRYSTAL	
			PROFILI - PREZZO € PROFILES - PRICE €	CROMO LUCIDO (CR) BRIGHT CHROME (CR)
FILAF 01	15X195		T	174,00
			GY	205,00
			ST	191,00
			SGY	226,00
FILAF 02	20X195	FI2F / FIMF / FILF / FIMFL	S3	188,00
			T	199,00
			GY	234,00
			ST	217,00
FILAF 03	35X195		SGY	254,00
			S3	214,00
			T	236,00
			GY	274,00
			ST	253,00
			SGY	294,00
			S3	247,00

Dai prezzi sono esclusi: IVA e spese di trasporto. Per articoli su misura considerare i prezzi di listino maggiorati del 40%

Prices do not include: VAT and freight costs.

Custom products +40% on price list.

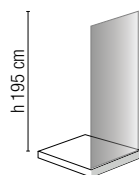

· Cristallo temperato 6 mm

FINITURA LASTRA

- Trasparente (T)
- Grey (GY)
- Serigrafato (S3)
- Specchio trasparente (ST)
- Specchio grey (SGY)

COLORI PROFILO

- Cromo lucido (CR)



MEDIO
MIDDLE



Di serie,
compreso
nel prezzo
Standard,
including
in the price

· Tempered 6 mm crystal

GLASS

- Clear (T)
- Grey (GY)
- Silk-screen (S3)
- Transparent Mirror (ST)
- Grey mirror (SGY)

TRIM COLORS

- Bright chrome (CR)

FIJI

Lato fisso a muro

Fixed side panel

CODICE CODE	ESTENSIBILITÀ cm EXTENSIBILITY cm	DA ABBINARE CON TO COMBINE WITH	FINITURA LASTRA CRISTALLO 6 mm GLASS 6 mm CRYSTAL	
			PROFILI - PREZZO € PROFILES - PRICE €	CROMO LUCIDO (CR) BRIGHT CHROME (CR)
FIFM 01	66/67		T	376,00
			GY	424,00
			ST	48,00
			SGY	509,00
FIFM 02	72/73		S3	-
			T	376,00
			GY	424,00
			ST	48,00
FIFM 03	77/78	FIL / FILF / FIMFL	SGY	509,00
			S3	-
			T	429,00
			GY	473,00
			ST	552,00
FIFM 04	87/88		SGY	582,00
			S3	-
			T	429,00
			GY	473,00
			ST	552,00
FIFM 05	97/98		SGY	582,00
			S3	-
			T	449,00
			GY	493,00
			ST	612,00
			SGY	655,00
			S3	-

A richiesta porta-salviette L 42 CM € 75,00

On demand towel holder L 42 CM € 75,00

Dai prezzi sono esclusi: IVA e spese di trasporto. Per articoli su misura considerare i prezzi di listino maggiorati del 40%

Prices do not include: VAT and freight costs.

Custom products +40% on price list.



ALICUDI

- Lato per box angolare a due ante scorrevoli
- Porta ad un'anta scorrevole e una fissa da abbinare alla parete fissa laterale (comporre con articolo AF)
- Porta ad un'anta scorrevole per nicchia
- Parete fissa laterale (comporre con art. APSF)

- *Side for corner entry shower enclosure two sliding sections*
- *Two-section door, 1 sliding + 1 fixed to combine with fixed side AF*
- *Two-section door, 1 sliding + 1 fixed for niche*
- *Fixed panel to combine with APSF*

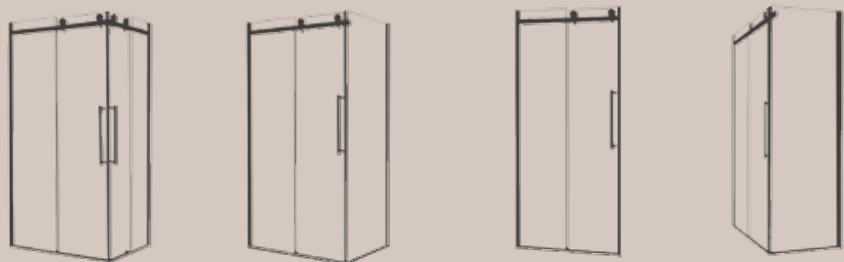

ALICUDI



APSF 01 + AF 02





APS 04



ALI
CUDI

Come per un orologio di pregio,
la collezione Alicudi è design da
mostrare in tutta la sua precisione;
la maniglia si adatta alla sua
personalità aggressiva ed estroversa
per non passare inosservata.

*Like a fine watch, Alicudi collection is
design to show in all its accuracy;
the handle reflects its aggressive and
outgoing personality not to go unnoticed.*





AA 03 + AA 03

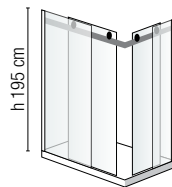

- Scorrimento superiore
- Perno di sicurezza
- Cristallo temperato 8 mm

FINITURA LASTRA

- Trasparente (T)

COLORI PROFILO

- Cromo lucido (CR)



BUONO
GOOD

- Upper sliding
- Safety hinge
- Tempered 8 mm crystal

GLASS

- Clear (T)

TRIM COLORS

- Bright chrome (CR)

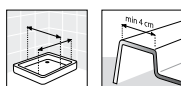

Di serie, compreso
nel prezzo
Standard,
including in the price

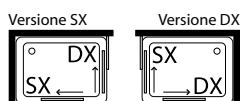

Per piatto doccia rettangolare
indicare se il lato lungo va a sx o a dx
In case of rectangular shower tray indicate
if the long side is on the left or on the right

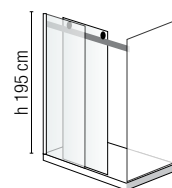

- Scorrimento superiore
- Perno di sicurezza
- Cristallo temperato 8 mm

FINITURA LASTRA

- Trasparente (T)

COLORI PROFILO

- Cromo lucido (CR)



BUONO
GOOD

- Upper sliding
- Safety hinge
- Tempered 8 mm crystal

GLASS

- Clear (T)

TRIM COLORS

- Bright chrome (CR)



Di serie, compreso
nel prezzo
Standard,
including in the price



Versione sx con parete
fissa laterale dx
Left version with a fixed
panel on the right side

Versione dx con parete
fissa laterale sx
Right version with a fixed
panel on the left side

ALICUDI

Lato per angolo a due ante scorrevoli
Side for corner entry shower enclosure two sliding sections

CODICE CODE	ESTENSIBILITÀ cm EXTENSIBILITY cm	APERTURA cm* OPENING cm	FINITURA LASTRA CRISTALLO 8 mm GLASS 8 mm CRYSTAL	PROFILI - PREZZO € PROFILES - PRICE €
				CROMO LUCIDO (CR) BRIGHT CHROME (CR)
AA 70	68/69,5	34	T	902,00
AA 80	78/79,5	39	T	902,00
AA 90	88/89,5	44	T	915,00
AA 100	98/99,5	44	T	935,00
AA 120	118/119,5	52	T	979,00

*Apertura determinata con due lati della stessa misura.

*Opening is calculated with two sides of the same measure

Indicare la versione sx o dx.

Specify version SX (left) - DX (right).

Profilo di tenuta di serie in alluminio da sigillare L 14 x h 10,5 mm.

Issued aluminium profile to seal, 14 mm largex 10,5 mm high.

Dai prezzi sono esclusi: IVA e spese di trasporto. Per articoli su misura considerare i prezzi di listino maggiorati del 40%

Prices do not include: VAT and freight costs.

Custom products +40% on price list.

ALICUDI

Porta ad un'anta scorrevole e una fissa
da abbinare alla parete fissa laterale
(comporre con art. AF)

Two-section door, 1 sliding + 1 fixed to combine
with fixed side AF

CODICE CODE	ESTENSIBILITÀ cm EXTENSIBILITY cm	APERTURA cm OPENING cm	FINITURA LASTRA CRISTALLO 8 mm GLASS 8 mm CRYSTAL	PROFILI - PREZZO € PROFILES - PRICE €
				CROMO LUCIDO (CR) BRIGHT CHROME (CR)
APSF 01	118/120	50	T	1399,00
APSF 02	128/130	50	T	1399,00
APSF 03	138/140	60	T	1486,00
APSF 04	148/150	60	T	1486,00
APSF 05	158/160	60	T	1541,00
APSF 06	168/170	70	T	1541,00
APSF 07	178/181	70	T	1541,00
APSF 08	188/190	70	T	1651,00
APSF 09	198/200	70	T	1651,00

Il prezzo è della sola porta scorrevole.

Price is referred to the only sliding door.

Profilo di tenuta di serie in alluminio da sigillare L 14 x h 10,5 mm.

Issued aluminium profile to seal, 14 mm largex 10,5 mm high.

Dai prezzi sono esclusi: IVA e spese di trasporto. Per articoli su misura considerare i prezzi di listino maggiorati del 40%

Prices do not include: VAT and freight costs.

Custom products +40% on price list.



- Scorrimento superiore
- Perno di sicurezza
- Cristallo temperato 8 mm

FINITURA LASTRA

- Trasparente (T)

COLORI PROFILO

- Cromo lucido (CR)



BUONO
GOOD

- Upper sliding
- Safety hinge
- Tempered 8 mm crystal

GLASS

- Clear (T)

TRIM COLORS

- Bright chrome (CR)

Versione SX

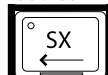

Versione DX

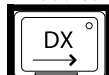

Indicare il senso di apertura
Indicate the opening direction



Di serie, compreso
nel prezzo
Standard,
including in the price

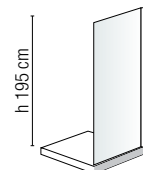

- Cristallo temperato 8 mm

FINITURA LASTRA

- Trasparente (T)

COLORI PROFILO

- Cromo lucido (CR)



BUONO
GOOD

- Tempered 8 mm crystal

GLASS

- Clear (T)

TRIM COLORS

- Bright chrome (CR)



Di serie, compreso
nel prezzo
Standard,
including in the price

ALICUDI

Porta ad un'anta scorrevole per nicchia
Two-section door, 1 sliding + 1 fixed for niche

CODICE CODE	ESTENSIBILITÀ cm EXTENSIBILITY cm	APERTURA cm OPENING cm	FINITURA LASTRA CRISTALLO 8 mm GLASS 8 mm CRYSTAL	PROFILI - PREZZO € PROFILES - PRICE €
				CROMO LUCIDO (CR) BRIGHT CHROME (CR)
APS 01	118/121	48	T	1454,00
APS 02	128/131	48	T	1454,00
APS 03	138/141	58	T	1541,00
APS 04	148/151	58	T	1541,00
APS 05	158/161	58	T	1601,00
APS 06	168/171	68	T	1601,00
APS 07	178/181	68	T	1601,00
APS 08	188/191	68	T	1717,00
APS 09	198/201	68	T	1717,00

Profilo di tenuta di serie in alluminio da sigillare L 14 x h 10,5 mm.

Optional aluminium profile to seal, 14 mm largex 10,5 mm high.

Dai prezzi sono esclusi: IVA e spese di trasporto. Per articoli su misura considerare i prezzi di listino maggiorati del 40%

Prices do not include: VAT and freight costs.

Custom products +40% on price list.

ALICUDI

Parete fissa laterale
(comporre con art. APSF)
Fixed panel to combine with APSF

CODICE CODE	ESTENSIBILITÀ cm EXTENSIBILITY cm	FINITURA LASTRA CRISTALLO 8 mm GLASS 8 mm CRYSTAL	PROFILI - PREZZO € PROFILES - PRICE €
			CROMO LUCIDO (CR) BRIGHT CHROME (CR)
AF 01	68/69,5	T	423,00
AF 02	73/74,5	T	423,00
AF 03	78/79,5	T	423,00
AF 04	88/89,5	T	462,00
AF 05	98/99,5	T	462,00

Dai prezzi sono esclusi: IVA e spese di trasporto. Per articoli su misura considerare i prezzi di listino maggiorati del 40%

Prices do not include: VAT and freight costs.

Custom products +40% on price list.

TONGA

- Lato per box angolare a due ante scorrevoli
- Semicircolare a due ante scorrevoli
- Porta ad un'anta scorrevole e una fissa
- Porta a due ante scorrevoli e due fisse
- Parete fissa

- *Side for corner entry shower enclosure two sliding sections*
- *Quadrant shower enclosure 2 sliding sections*
- *Two-section door, 1 sliding + 1 fixed*
- *Shower enclosure door, 2 sliding + 2 fixed*
- *Fixed side panel*

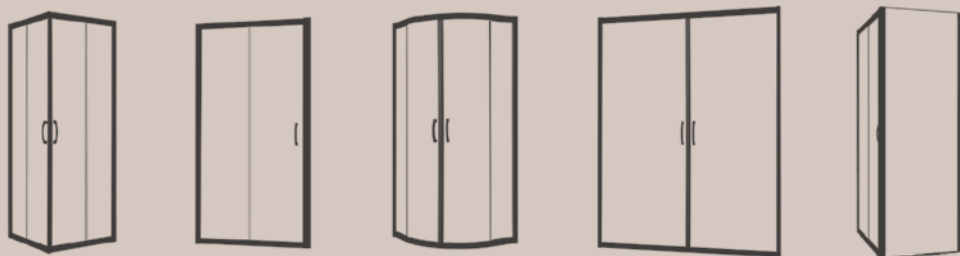



TON GA



TON GA

Carrello di scorrimento
a sgancio rapido

Sliding system with fast release





TS 05



TA80+TA100



Solidità e leggerezza allo stesso tempo; scorrimento preciso ed affidabile regolabile grazie al sistema eccentrico, giunti ed estrusi minimal per non rinunciare alla grazia del prodotto Made in Italy.

Solidity and lightness at the same time; accurate and reliable sliding thanks to the eccentric system, minimal trimmings not to give up the charm of Made in Italy product.

TON GA





TON GA

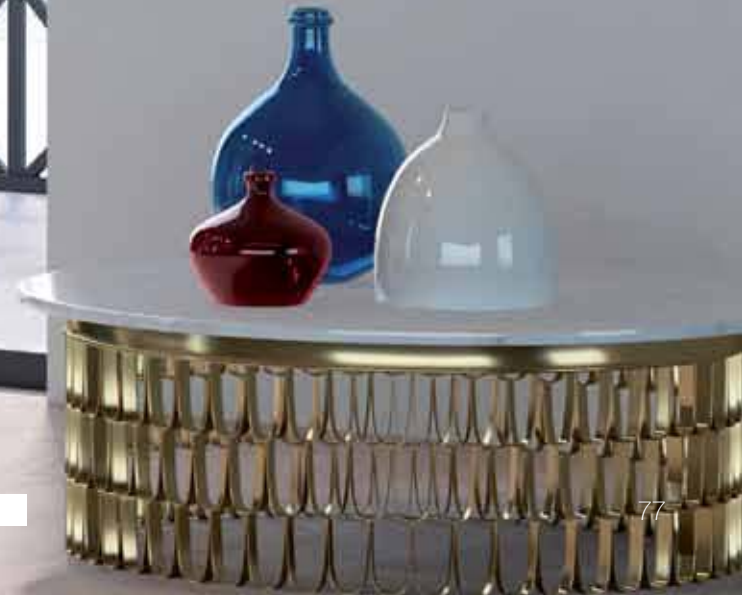
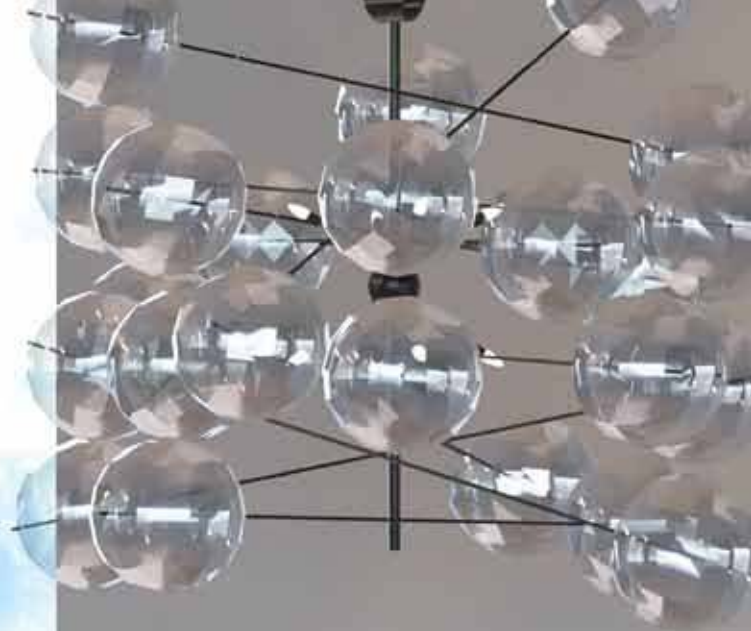

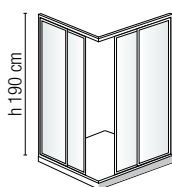

OTTIMO
EXCELLENT



Disponibile
su richiesta
a € 66,00
Available
on request
at € 66,00

- Scorrimento su cuscinetti a sfera regolabili a sgancio rapido
- Cristallo temperato 6 mm

FINITURA LASTRA

- Stampato (C)
- Trasparente (T)
- Satinato (SA)
- Serigrafato (S1)

COLORI PROFILO

- Bianco (BI)
- Argento lucido gloss 420 (ARGL)
- Argento satinato (ARS)

Abbinabile con il lato fisso TF per trasformarsi in una cabina tre lati

- Sliding on ball bearings fast release
- Tempered glass 6 mm

GLASS

- Printed (C)
- Clear (T)
- Glazed (SA)
- Screen printed (S1)

TRIM COLORS

- White (BI)
- Silver polish gloss 420 (ARGL)
- Silver satin (ARS)

Couppable with fixed side TF to become a three sides shower unit

Dai prezzi sono esclusi: IVA e spese di trasporto. Per articoli su misura considerare i prezzi di listino maggiorati del 40%

Prices do not include: VAT and freight costs. Custom products +40% on price list.

TONGA

Lato per box angolare a due ante scorrevoli
Side for corner entry shower enclosure two sliding sections

CODICE CODE	ESTENSIBILITÀ cm EXTENSIBILITY cm	APERTURA cm* OPENING cm	FINITURA LASTRA CRISTALLO 6 mm GLASS 6 mm CRYSTAL	PROFILI - PREZZO € PROFILES - PRICE €		
				BIANCO (BI) WHITE (BI)	ARGENTO LUCIDO (ARL) SILVER POLISH (ARL)	ARGENTO SATINATO (ARS) SILVER SATIN (ARS)
TA 70	68,5/71	38	C	225,00	256,00	256,00
			T	225,00	256,00	256,00
			S1	252,00	287,00	287,00
			SA	252,00	287,00	287,00
TA 75	72,5/75	39	C	225,00	256,00	256,00
			T	225,00	256,00	256,00
			S1	252,00	287,00	287,00
			SA	252,00	287,00	287,00
TA 80	77,5/80	42	C	243,00	276,00	276,00
			T	243,00	276,00	276,00
			S1	272,00	309,00	309,00
			SA	272,00	309,00	309,00
TA 90	87,5/90	49	C	257,00	293,00	293,00
			T	257,00	293,00	293,00
			S1	288,00	327,00	327,00
			SA	288,00	327,00	327,00
TA 100	97,5/100	52	C	278,00	316,00	316,00
			T	278,00	316,00	316,00
			S1	312,00	353,00	353,00
			SA	312,00	353,00	353,00
TA 120	117,5/120	59	C	300,00	342,00	342,00
			T	300,00	342,00	342,00
			S1	336,00	383,00	383,00
			SA	336,00	383,00	383,00

* Apertura determinata con due lati della stessa misura.

* Opening is calculated with two sides of the same measure

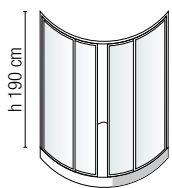

OTTIMO
EXCELLENT



Disponibile
su richiesta
a € 135,00
Available
on request
at € 135,00

- Scorrimento su cuscinetti a sfera regolabili a sgancio rapido
- Cristallo temperato 6 mm

FINITURA LASTRA

- Stampato (C)
- Trasparente (T)
- Satinato (SA)
- Serigrafato (S1)

COLORI PROFILO

- Bianco (BI)
- Argento lucido gloss 420 (ARGL)
- Argento satinato (ARS)

- Sliding on ball bearings fast release
- Tempered glass 6 mm

CRYSTAL FINISHING

- Printed (C)
- Clear (T)
- Glazed (SA)
- Screen printed (S1)

TRIM COLORS

- White (BI)
- Silver polish gloss 420 (ARGL)
- Silver satin (ARS)

Dai prezzi sono esclusi: IVA e spese di trasporto. Non si producono articoli su misura della serie semicircolare.

Prices do not include: VAT and transport costs. Does not produce articles of semi-circular extent of the series.

TONGA

Semicircolare a due ante scorrevoli
Quadrant shower enclosure 2 sliding sections

CODICE CODE	ESTENSIBILITÀ cm EXTENSIBILITY cm	APERTURA cm OPENING cm	FINITURA LASTRA CRISTALLO 6 mm GLASS 6 mm CRYSTAL	PROFILI - PREZZO € PROFILES - PRICE €		
				BIANCO (BI) WHITE (BI)	ARGENTO LUCIDO (ARL) SILVER POLISH (ARL)	ARGENTO SATINATO (ARS) SILVER SATIN (ARS)
TS 04	77,5/80	42	C	544,00	612,00	612,00
			T	544,00	612,00	612,00
			S1	-	-	-
			SA	617,00	685,00	685,00
TS 05	87,5/90	42	C	609,00	631,00	631,00
			T	609,00	631,00	631,00
			S1	-	-	-
			SA	682,00	704,00	704,00
TS 06	72,5/75	35	C	640,00	720,00	720,00
			T	640,00	720,00	720,00
			S1	-	-	-
			SA	713,00	793,00	793,00
TS 07	67,5/70+87,5/90	45	C	689,00	774,00	774,00
			T	689,00	774,00	774,00
			S1	-	-	-
			SA	762,00	847,00	847,00

TONGA

Porta ad un'anta scorrevole e una fissa
Two-section door, 1 sliding + 1 fixed

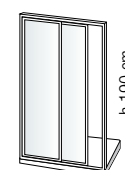

OTTIMO
EXCELLENT



Disponibile
su richiesta
a € 106,00
Available
on request
at € 106,00

CODICE CODE	ESTENSIBILITÀ cm EXTENSIBILITY cm	APERTURA cm OPENING cm	FINITURA LASTRA CRISTALLO 6 mm GLASS 6 mm CRYSTAL	PROFILI - PREZZO € PROFILES - PRICE €		
				BIANCO (BI) WHITE (BI)	ARGENTO LUCIDO (AGL) SILVER POLISH (ARL)	ARGENTO SATINATO (ARS) SILVER SATIN (ARS)
TPS 05/S	92/97	35	C	423,00	477,00	477,00
			T	423,00	477,00	477,00
			S1	499,00	552,00	552,00
			SA	499,00	552,00	552,00
TPS 06	97/102	39	C	423,00	477,00	477,00
			T	423,00	477,00	477,00
			S1	499,00	552,00	552,00
			SA	499,00	552,00	552,00
TPS 06/S	102/107	35	C	437,00	492,00	492,00
			T	437,00	492,00	492,00
			S1	513,00	568,00	568,00
			SA	513,00	568,00	568,00
TPS 07/S	107/112	39	C	437,00	492,00	492,00
			T	437,00	492,00	492,00
			S1	513,00	568,00	568,00
			SA	513,00	568,00	568,00
TPS 10	112/117	39	C	437,00	492,00	492,00
			T	437,00	492,00	492,00
			S1	513,00	568,00	568,00
			SA	513,00	568,00	568,00
TPS 07	117/122	49	C	437,00	492,00	492,00
			T	437,00	492,00	492,00
			S1	513,00	568,00	568,00
			SA	513,00	568,00	568,00
TPS 08/S	122/127	49	C	478,00	538,00	538,00
			T	478,00	538,00	538,00
			S1	546,00	614,00	614,00
			SA	546,00	614,00	614,00
TPS 08	127/132	59	C	478,00	538,00	538,00
			T	478,00	538,00	538,00
			S1	546,00	614,00	614,00
			SA	546,00	614,00	614,00
TPS 09/S	132/137	55	C	487,00	548,00	548,00
			T	487,00	548,00	548,00
			S1	563,00	624,00	624,00
			SA	563,00	624,00	624,00
TPS 09	137/142	68	C	487,00	548,00	548,00
			T	487,00	548,00	548,00
			S1	563,00	624,00	624,00
			SA	563,00	624,00	624,00



Dai prezzi sono esclusi: IVA e spese di trasporto. Per articoli su misura considerare i prezzi di listino maggiorati del 40%

Prices do not include: VAT and freight costs.
Custom products +40% on price list.

- Scorrimento su cuscinetti a sfera regolabili a sgancio rapido
- Cristallo temperato 6 mm

FINITURA LASTRA

- Stampato (C)
- Trasparente (T)
- Satinato (SA)
- Serigrafato (S1)

COLORI PROFILO

- Bianco (BI)
- Argento lucido gloss 420 (ARGL)
- Argento satinato (ARS)

Abbinabile con il lato fisso TF per trasformarsi in una cabina a due o tre lati

- Sliding on ball bearings fast release
- Tempered glass 6 mm

GLASS

- Printed (C)
- Clear (T)
- Glazed (SA)
- Screen printed (S1)

TRIM COLORS

- White (BI)
- Silver polish gloss 420 (ARGL)
- Silver satin (ARS)

Couppable with fixed side TF to become a two or three sides shower unit

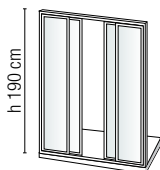

OTTIMO
EXCELLENT



Disponibile
su richiesta
a € 135,00
Available
on request
at € 135,00

Dai prezzi sono esclusi: IVA e spese di trasporto.
Per articoli su misura considerare i prezzi di listino maggiorati del 40%

Prices do not include: VAT and transport costs.
For custom orders considering the list prices increased by +40%

- Scorrimento
su cuscinetti a sfera
regolabili a sgancio rapido
- Cristallo temperato 6 mm

FINITURA LASTRA

- Stampato (C)
- Trasparente (T)
- Satinato (SA)
- Serigrafato (S1)

COLORI PROFILO

- Bianco (BI)
- Argento lucido
gloss 420 (ARGL)
- Argento satinato (ARS)

Abbinabile con il lato fisso TF
per trasformarsi in una cabina
a due o tre lati

- Ball bearings sliding system, adjustable with fast release
- Tempered glass 6 mm

GLASS

- Printed (C)
- Clear (T)
- Glazed (SA)
- Screen printed (S1)

TRIM COLORS

- White (BI)
- Silver polish gloss 420 (ARGL)
- Silver satin (ARS)

Couppable with fixed side TF to become
a two or three sides shower unit

TONGA

Porta due ante scorrevoli e due fisse
Shower enclosure door, 2 sliding + 2 fixed

CODICE CODE	ESTENSIBILITÀ cm EXTENSIBILITY cm	APERTURA cm OPENING cm	FINITURA LASTRA CRISTALLO 6 mm GLASS 6 mm CRYSTAL	PROFILI - PREZZO € PROFILES - PRICE €		
				BIANCO (BI) WHITE (BI)	ARGENTO LUCIDO (ARL) SILVER POLISH (ARL)	ARGENTO SATINATO (ARS) SILVER SATIN (ARS)
TP2S 14	137/142	50	C	616,00	693,00	693,00
			T	616,00	693,00	693,00
			S1	692,00	768,00	768,00
			SA	692,00	768,00	768,00
TP2S 14/S	142/147	50	C	616,00	693,00	693,00
			T	616,00	693,00	693,00
			S1	692,00	768,00	768,00
			SA	692,00	768,00	768,00
TP2S 15	147/152	55	C	616,00	693,00	693,00
			T	616,00	693,00	693,00
			S1	692,00	768,00	768,00
			SA	692,00	768,00	768,00
TP2S 16	152/157	55	C	709,00	798,00	798,00
			T	709,00	798,00	798,00
			S1	785,00	873,00	873,00
			SA	785,00	873,00	873,00
TP2S 17	157/162	65	C	709,00	798,00	798,00
			T	709,00	798,00	798,00
			S1	785,00	873,00	873,00
			SA	785,00	873,00	873,00
TP2S 18	162/167	65	C	709,00	798,00	798,00
			T	709,00	798,00	798,00
			S1	785,00	873,00	873,00
			SA	785,00	873,00	873,00
TP2S 19	167/172	75	C	753,00	846,00	846,00
			T	753,00	846,00	846,00
			S1	828,00	922,00	922,00
			SA	828,00	922,00	922,00
TP2S 20	172/177	75	C	753,00	846,00	846,00
			T	753,00	846,00	846,00
			S1	828,00	922,00	922,00
			SA	828,00	922,00	922,00
TP2S 21	177/182	80	C	753,00	846,00	846,00
			T	753,00	846,00	846,00
			S1	828,00	922,00	922,00
			SA	828,00	922,00	922,00
TP2S 22	182/187	80	C	753,00	846,00	846,00
			T	753,00	846,00	846,00
			S1	828,00	922,00	922,00
			SA	828,00	922,00	922,00
TP2S 23	187/192	80	C	846,00	951,00	951,00
			T	846,00	951,00	951,00
			S1	922,00	1027,00	1027,00
			SA	922,00	1027,00	1027,00
TP2S 24	192/197	80	C	846,00	951,00	951,00
			T	846,00	951,00	951,00
			S1	922,00	1027,00	1027,00
			SA	922,00	1027,00	1027,00

TONGA

Parete fissa
Fixed side panel

CODICE CODE	ESTENSIBILITÀ cm EXTENSIBILITY cm	FINITURA LASTRA CRISTALLO 6 mm GLASS 6 mm CRYSTAL	PROFILI - PREZZO € PROFILES - PRICE €		
			BIANCO (BI) WHITE (BI)	ARGENTO LUCIDO (ARGL) SILVER POLISH (ARGL)	ARGENTO SATINATO (ARS) SILVER SATIN (ARS)
TF 03	66/71	C	295,00	325,00	325,00
		T	295,00	325,00	325,00
		S1	372,00	407,00	407,00
		SA	372,00	407,00	407,00
TF 04	71/76	C	295,00	325,00	325,00
		T	295,00	325,00	325,00
		S1	372,00	407,00	407,00
		SA	372,00	407,00	407,00
TF 05	76/81	C	295,00	325,00	325,00
		T	295,00	325,00	325,00
		S1	372,00	407,00	407,00
		SA	372,00	407,00	407,00
TF 06	81/86	C	301,00	335,00	335,00
		T	301,00	335,00	335,00
		S1	380,00	413,00	413,00
		SA	380,00	413,00	413,00
TF 07	86/91	C	301,00	335,00	335,00
		T	301,00	335,00	335,00
		S1	380,00	413,00	413,00
		SA	380,00	413,00	413,00
TF 08	91/96	C	311,00	348,00	348,00
		T	311,00	348,00	348,00
		S1	390,00	426,00	426,00
		SA	390,00	426,00	426,00
TF 09	96/101	C	311,00	348,00	348,00
		T	311,00	348,00	348,00
		S1	390,00	426,00	426,00
		SA	390,00	426,00	426,00

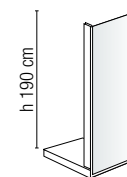

OTTIMO
EXCELLENT



Disponibile
su richiesta
a € 80,00
Available
on request
at € 80,00



Dai prezzi sono esclusi: IVA e spese di trasporto.
Per articoli su misura considerare i prezzi di listino
maggiorati del 40%

Prices do not include: VAT and transport costs.
For custom orders considering the list prices increased by +40%

- Parete fissa per Tonga
TA - TPS - TP2S
- Cristallo temperato 6 mm

FINITURA LASTRA

- Stampato (C)
- Trasparente (T)
- Satinato (SA)
- Serigrafato (S1)

COLORI PROFILO

- Bianco (BI)
- Argento lucido
gloss 420 (ARGL)
- Argento satinato (ARS)

- Fixed panel
for Tonga TA - TPS - TP2S
- Tempered glass 6 mm

GLASS

- Printed (C)
- Clear (T)
- Glazed (SA)
- Screen printed (S1)

TRIM COLORS

- White (BI)
- Silver polish gloss 420 (ARGL)
- Silver satin (ARS)

DOMINGO



- Porta ad un'anta battente apertura esterna e parete fissa in linea
- Porta ad un'anta battente apertura esterna
- Parete fissa
- Porta a 2 ante battenti apertura esterna

- *Shower door, 1 hinged door and fixed panel in line*
- *Shower door, 1 hinged door*
- *Fixed side panel*
- *Shower door, two hinged doors*





DBM 11

DOMI NINGO



DOMINGO

DB 07





D2B 12 + DF 03



L'apertura risulta morbida grazie al sistema di rotazione su perno e alla maniglia pratica ed essenziale.

A soft opening thanks to the rotation system based on pivot and the essential and practical handle.

DOMINGO

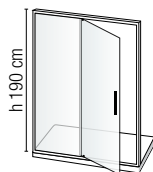

OTTIMO
EXCELLENT



Disponibile
su richiesta
a € 135,00
Available
on request
at € 135,00

· Cristallo temperato 6 mm

FINITURA LASTRA

- Trasparente (T)
- Satinato (SA)

COLORI PROFILO

- Bianco (BI)
- Cromo lucido (CR)

Abbinabile con il lato fisso DF per trasformarsi in una cabina a due o tre lati

· Tempered 6 mm crystal

GLASS

- Clear (T)
- Glazed (SA)

TRIM COLORS

- White (BI)
- Bright chrome (CR)

Combinabile with fixed side DF to become a cabin two or three sides

Dai prezzi sono esclusi: IVA e spese di trasporto. Per articoli su misura considerare i prezzi di listino maggiorati del 40%

Prices do not include: VAT and freight costs.
Custom products +40% on price list.



OTTIMO
EXCELLENT



Disponibile
su richiesta
a € 106,00
Available
on request
at € 106,00

· Cristallo temperato 6 mm

FINITURA LASTRA

- Trasparente (T)
- Satinato (SA)

COLORI PROFILO

- Bianco (BI)
- Cromo lucido (CR)

Abbinabile con il lato fisso DF per trasformarsi in una cabina a due o tre lati

· Tempered 6 mm crystal

GLASS

- Clear (T)
- Glazed (SA)

TRIM COLORS

- White (BI)
- Bright chrome (CR)

Combinabile with fixed side DF to become a cabin two or three sides

Dai prezzi sono esclusi: IVA e spese di trasporto. Per articoli su misura considerare i prezzi di listino maggiorati del 40%

Prices do not include: VAT and freight costs.
Custom products +40% on price list.

DOMINGO

Porta ad un'anta battente
apertura esterna e parete fissa in linea
Shower door, 1 hinged door and fixed panel in line

CODICE CODE	ESTENSIBILITÀ cm EXTENSIBILITY cm	APERTURA cm OPENING cm	FINITURA LASTRA CRISTALLO 6 mm GLASS 6 mm CRYSTAL	PROFILI - PREZZO € PROFILES - PRICE €	
				BIANCO (BI) WHITE (BI)	CROMO LUCIDO (CR) BRIGHT CHROME (CR)
DBM 01	117/122	50	T	678,00	826,00
			SA	860,00	1009,00
DBM 02	122/127	50	T	678,00	826,00
			SA	860,00	1009,00
DBM 03	127/132	50	T	678,00	826,00
			SA	860,00	1009,00
DBM 04	132/137	50	T	709,00	857,00
			SA	891,00	1039,00
DBM 05	137/142	50	T	709,00	857,00
			SA	891,00	1039,00
DBM 06	142/147	60	T	709,00	857,00
			SA	891,00	1039,00
DBM 07	147/152	60	T	737,00	886,00
			SA	920,00	1068,00
DBM 08	152/157	60	T	737,00	886,00
			SA	920,00	1068,00
DBM 09	157/162	60	T	737,00	886,00
			SA	920,00	1068,00
DBM 10	162/167	60	T	766,00	914,00
			SA	948,00	1096,00
DBM 11	167/172	60	T	766,00	914,00
			SA	948,00	1096,00
DBM 12	172/177	60	T	791,00	939,00
			SA	973,00	1121,00
DBM 13	177/182	60	T	791,00	939,00
			SA	973,00	1121,00

DOMINGO

Porta ad un'anta battente
apertura esterna
Shower door, 1 hinged door

CODICE CODE	ESTENSIBILITÀ cm EXTENSIBILITY cm	APERTURA cm OPENING cm	FINITURA LASTRA CRISTALLO 6 mm GLASS 6 mm CRYSTAL	PROFILI - PREZZO € PROFILES - PRICE €	
				BIANCO (BI) WHITE (BI)	CROMO LUCIDO (CR) BRIGHT CHROME (CR)
DB 03	67/72	40	T	451,00	540,00
			SA	561,00	650,00
DB 04	72/77	50	T	451,00	540,00
			SA	561,00	650,00
DB 05	77/82	50	T	451,00	540,00
			SA	561,00	650,00
DB 06	82/87	60	T	486,00	574,00
			SA	595,00	684,00
DB 07	87/92	60	T	486,00	574,00
			SA	595,00	684,00
DB 08	97/102	60	T	508,00	597,00
			SA	618,00	707,00

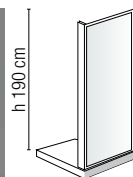

OTTIMO
EXCELLENT



Disponibile
su richiesta
a € 80,00
Available
on request
at € 80,00

- Parete fissa per Domingo
DA - DBM - DB - D2B
- Cristallo temperato 6 mm

FINITURA LASTRA

- Trasparente (T)
- Satinato (SA)

COLORI PROFILO

- Bianco (BI)
- Cromo lucido (CR)

- Fixed side for Domingo
DA - DBM - DB - D2B
- Tempered 6 mm crystal

GLASS

- Clear (T)
- Glazed (SA)

TRIM COLORS

- White (BI)
- Bright chrome (CR)

DOMINGO

Parete fissa
Fixed side panel

CODICE CODE	ESTENSIBILITÀ cm EXTENSIBILITY cm	FINITURA LASTRA CRISTALLO 6 mm GLASS 6 mm CRYSTAL	PROFILI - PREZZO € PROFILES - PRICE €	
			BIANCO (BI) WHITE (BI)	CROMO LUCIDO (CR) BRIGHT CHROME (CR)
DF 03	66/71	T	338,00	402,00
		SA	423,00	448,00
DF 04	71/76	T	338,00	402,00
		SA	423,00	448,00
DF 05	76/81	T	338,00	402,00
		SA	423,00	448,00
DF 06	81/86	T	347,00	410,00
		SA	431,00	456,00
DF 07	86/91	T	347,00	410,00
		SA	431,00	456,00
DF 08	91/96	T	358,00	421,00
		SA	442,00	467,00
DF 09	96/101	T	358,00	421,00
		SA	442,00	467,00

Dai prezzi sono esclusi: IVA e spese di trasporto. Per articoli su misura considerare i prezzi di listino maggiorati del 40%
Prices do not include: VAT and freight costs.
Custom products +40% on price list.

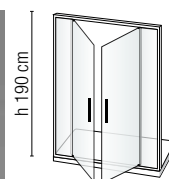

OTTIMO
EXCELLENT



Disponibile
su richiesta
a € 135,00
Available
on request
at € 135,00

- Cristallo temperato 6 mm

FINITURA LASTRA

- Trasparente (T)
- Satinato (SA)

COLORI PROFILO

- Bianco (BI)
- Cromo lucido (CR)

Abbinabile con il lato fisso DF per
trasformarsi in una cabina a due
o tre lati

- Tempered 6 mm crystal

GLASS

- Clear (T)
- Glazed (SA)

TRIM COLORS

- White (BI)
- Bright chrome (CR)

Combinabile with fixed side DF
to become a cabin two or three sides

DOMINGO

Porta a due ante battenti
apertura esterna
Shower door, two hinged doors

CODICE CODE	ESTENSIBILITÀ cm EXTENSIBILITY cm	APERTURA cm OPENING cm	FINITURA LASTRA CRISTALLO 6 mm GLASS 6 mm CRYSTAL	PROFILI - PREZZO € PROFILES - PRICE €	
				BIANCO (BI) WHITE (BI)	CROMO LUCIDO (CR) BRIGHT CHROME (CR)
D2B 01	117/122	87	T	712,00	860,00
			SA	895,00	1043,00
D2B 02	122/127	87	T	712,00	860,00
			SA	895,00	1043,00
D2B 03	127/132	87	T	712,00	860,00
			SA	895,00	1043,00
D2B 04	132/137	87	T	747,00	895,00
			SA	932,00	1077,00
D2B 05	137/142	98	T	747,00	895,00
			SA	932,00	1077,00
D2B 06	142/147	98	T	747,00	895,00
			SA	932,00	1077,00
D2B 07	147/152	98	T	775,00	923,00
			SA	957,00	1106,00
D2B 08	152/157	98	T	775,00	923,00
			SA	957,00	1106,00
D2B 09	157/162	118	T	775,00	923,00
			SA	957,00	1106,00
D2B 10	162/167	118	T	803,00	952,00
			SA	986,00	1134,00
D2B 11	167/172	118	T	803,00	952,00
			SA	986,00	1134,00
D2B 12	172/177	118	T	803,00	952,00
			SA	986,00	1134,00
D2B 13	177/182	118	T	803,00	952,00
			SA	986,00	1134,00

Dai prezzi sono esclusi: IVA e spese di trasporto. Per articoli su
misura considerare i prezzi di listino maggiorati del 40%

Prices do not include: VAT and freight costs.
Custom products +40% on price list.



LIPARI

- Lato per angolo a due ante battenti esterno/interno
 - Porta ad un'anta battente esterna (abbinabile alla parete fissa art. LFF)
 - Porta ad un'anta battente esterna
 - Porta a due ante battenti
 - Porta ad un'anta battente esterna + fisso per nicchia (abbinabile alla parete fissa art. LFL)
 - Semicircolare a due ante a battente
 - Parete fissa per L2B
 - Parete fissa per LBF
 - Parete fissa per LBFL
-
- *Side for corner entry shower enclosure 2 hinged doors*
 - *Shower door, 1 hinged door (combinable with fixed panel LFF)*
 - *Shower door, 1 hinged door*
 - *Shower door, two hinged doors*
 - *Shower door, 1 hinged door + fixed panel in line for niche (combinable with fixed panel LFL)*
 - *Quadrant shower enclosure 2 hinged doors*
 - *Fixed panel for L2B*
 - *Fixed panel for LBF*
 - *Fixed panel for LBFL*







LIPARI









LIPARI





LB 05

LIPARI



GP 066

Opzionale nuova maniglia.
New optional handle

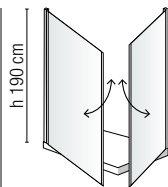

BUONO
GOOD

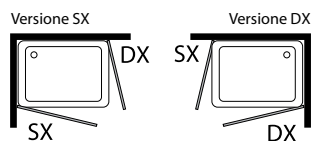

Per piatto doccia rettangolare indicare se il lato lungo va a sx o a dx
In case of rectangular shower tray indicate if the long side is on the left or on the right

· Cristallo temperato 6 mm

FINITURA LASTRA

- Stampato (C)
- Trasparente (T)
- Satinato (SA)
- Serigrafato (S3)

COLORI PROFILO

- Bianco (BI)
- Argento lucido (ARL)

· Tempered 6 mm crystal

GLASS

- Printed (C)
- Clear (T)
- Glazed (SA)
- Screen printed (S3)

TRIM COLORS

- White (BI)
- Silver polish (ARL)



Disponibile
su richiesta
a € 66,00
Available
on request
at € 66,00

LIPARI

Lato per angolo a due ante battenti
esterno/interno

Side for corner entry shower enclosure 2 hinged
doors

CODICE CODE	ESTENSIBILITÀ cm EXTENSIBILITY cm	APERTURA cm* OPENING cm	FINITURA LASTRA CRISTALLO 6 mm GLASS 6 mm CRYSTAL	PROFILI - PREZZO € PROFILES - PRICE €	
				BIANCO (BI) WHITE (BI)	ARGENTO LUCIDO (ARL) SILVER POLISH (ARL)
LA 70	66/68,5	54	C	260,00	306,00
			T	260,00	306,00
			S3	288,00	338,00
			SA	288,00	338,00
LA 75	71/73,5	64	C	260,00	306,00
			T	260,00	306,00
			S3	288,00	338,00
			SA	288,00	338,00
LA 80	76/78,5	69	C	260,00	306,00
			T	260,00	306,00
			S3	288,00	338,00
			SA	288,00	338,00
LA 85	81/83,5	75	C	277,00	326,00
			T	277,00	326,00
			S3	306,00	359,00
			SA	306,00	359,00
LA 90	86/88,5	79	C	277,00	326,00
			T	277,00	326,00
			S3	306,00	359,00
			SA	306,00	359,00
LA 100	96/98,5	80	C	281,00	331,00
			T	281,00	331,00
			S3	310,00	364,00
			SA	310,00	364,00
LA 120	116/118,5	100	C	281,00	331,00
			T	281,00	331,00
			S3	310,00	364,00
			SA	310,00	364,00

*Apertura determinata con due lati della stessa misura.
*Opening is calculated with two sides of the same measure

Indicare la versione sx o dx.
Specify version SX (left) - DX (right).

Profilo di tenuta di serie in alluminio da sigillare L 14 x h 10,5 mm.
Issued aluminium profile to seal, 14 mm largex 10,5 mm high.

Dai prezzi sono esclusi: IVA e spese di trasporto. Per articoli su misura considerare i prezzi di listino maggiorati del 40%
Prices do not include: VAT and freight costs.
Custom products +40% on price list.

Opzionale nuova maniglia
New optional handle



CODICE CODE	PREZZO € PRICE €
GP 066	54,00 cad.

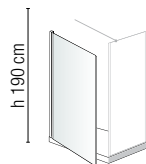

- Barra di sostegno
- Cristallo temperato 6 mm

FINITURA LASTRA

- Stampato (C)
- Trasparente (T)
- Satinato (SA)
- Serigrafato (S3)

COLORI PROFILO

- Bianco (BI)
- Argento lucido (ARL)



BUONO
GOOD



- Support bar
- Tempered 6 mm crystal

GLASS

- Printed (C)
- Clear (T)
- Glazed (SA)
- Screen printed (S3)



TRIM COLORS

- White (BI)
- Silver polish (ARL)



Dai prezzi sono esclusi:
IVA e spese di trasporto. Per articoli su
misura considerare i prezzi di listino
maggiorati del 40%



Prices do not include: VAT and freight costs.
Custom products +40% on price list.



Indicare la versione sx o dx.
Specify version SX (left) - DX (right).

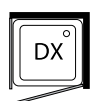

Indicare il senso di apertura
Indicate the opening direction



Disponibile
su richiesta
a € 66,00
Available
on request
at € 66,00

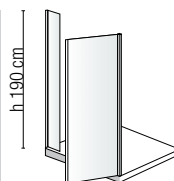

- Cristallo temperato 6 mm

FINITURA LASTRA

- Stampato (C)
- Trasparente (T)
- Satinato (SA)
- Serigrafato (S3)

COLORI PROFILO

- Bianco (BI)
- Argento lucido (ARL)



BUONO
GOOD



- Tempered 6 mm crystal

GLASS

- Printed (C)
- Clear (T)
- Glazed (SA)
- Screen printed (S3)



TRIM COLORS

- White (BI)
- Silver polish (ARL)



Dai prezzi sono esclusi:
IVA e spese di trasporto. Per articoli su
misura considerare i prezzi di listino
maggiorati del 40%



Prices do not include: VAT and freight costs.
Custom products +40% on price list.



Indicare la versione sx o dx.
Specify version SX (left) - DX (right).



Indicare il senso di apertura
Indicate the opening direction



Disponibile
su richiesta
a € 106,00
Available
on request
at € 106,00

LIPARI

Porta ad un'anta battente esterna
(abbinabile alla parete fissa art. LFF)

Shower door, 1 hinged door (combinable with fixed
panel LFF)

CODICE CODE	ESTENSIBILITÀ cm* EXTENSIBILITY cm	APERTURA cm OPENING cm	FINITURA LASTRA CRISTALLO 6 mm GLASS 6 mm CRYSTAL	PROFILI - PREZZO € PROFILES - PRICE €	
				BIANCO (BI) WHITE (BI)	ARGENTO LUCIDO (ARL) SILVER POLISH (ARL)
LBF 01	66/68,5	56	C	450,00	525,00
			T	450,00	525,00
			S3	474,00	552,00
			SA	474,00	552,00
LBF 02	71/73,5	63	C	450,00	525,00
			T	450,00	525,00
			S3	474,00	552,00
			SA	474,00	552,00
LBF 03	76/78,5	69	C	450,00	525,00
			T	450,00	525,00
			S3	474,00	552,00
			SA	474,00	552,00
LBF 04	86/88,5	79	C	487,00	564,00
			T	487,00	564,00
			S3	513,00	595,00
			SA	513,00	595,00

Profilo di tenuta di serie in alluminio da sigillare L 14 x h 10,5 mm.
Issued aluminium profile to seal, 14 mm largex 10,5 mm high.

LIPARI

Porta ad un'anta battente esterna
Shower door, 1 hinged door

CODICE CODE	ESTENSIBILITÀ cm EXTENSIBILITY cm	APERTURA cm OPENING cm	FINITURA LASTRA CRISTALLO 6 mm GLASS 6 mm CRYSTAL	PROFILI - PREZZO € PROFILES - PRICE €	
				BIANCO (BI) WHITE (BI)	ARGENTO LUCIDO (ARL) SILVER POLISH (ARL)
LB 01	67/72	54	C	465,00	542,00
			T	465,00	542,00
			S3	489,00	569,00
			SA	489,00	569,00
LB 02	72/77	59	C	465,00	542,00
			T	465,00	542,00
			S3	489,00	569,00
			SA	489,00	569,00
LB 03	77/82	64	C	465,00	542,00
			T	465,00	542,00
			S3	489,00	569,00
			SA	489,00	569,00
LB 04	87/92	74	C	499,00	575,00
			T	499,00	575,00
			S3	528,00	608,00
			SA	528,00	608,00
LB 05	97/102	84	C	499,00	575,00
			T	499,00	575,00
			S3	528,00	608,00
			SA	528,00	608,00

Profilo di tenuta di serie in alluminio da sigillare L 14 x h 10,5 mm.
Issued aluminium profile to seal, 14 mm largex 10,5 mm high.

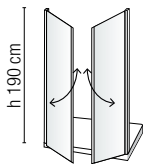

BUONO
GOOD



Disponibile
su richiesta
a € 135,00
Available
on request
at € 135,00

· Cristallo temperato 6 mm

FINITURA LASTRA

- Stampato (C)
- Trasparente (T)
- Satinato (SA)
- Serigrafato (S3)

COLORI PROFILO

- Bianco (BI)
- Argento lucido (ARL)

· Tempered 6 mm crystal

GLASS

- Printed (C)
- Clear (T)
- Glazed (SA)
- Screen printed (S3)

TRIM COLORS

- White (BI)
- Silver polish (ARL)

Dai prezzi sono esclusi:
IVA e spese di trasporto. Per articoli su
misura considerare i prezzi di listino
maggiorati del 40%

Prices do not include: VAT and freight costs.
Custom products +40% on price list.

LIPARI

Porta a due ante a battenti
Shower door, two hinged doors

CODICE CODE	ESTENSIBILITÀ cm EXTENSIBILITY cm	APERTURA cm OPENING cm	FINITURA LASTRA CRISTALLO 6 mm GLASS 6 mm CRYSTAL	PROFILI - PREZZO € PROFILES - PRICE €	
				BIANCO (BI) WHITE (BI)	ARGENTO LUCIDO (ARL) SILVER POLISH (ARL)
L2B 01	67/72	54	C	474,00	551,00
			T	474,00	551,00
			S3	503,00	575,00
			SA	503,00	575,00
L2B 02	72/77	59	C	474,00	551,00
			T	474,00	551,00
			S3	503,00	575,00
			SA	503,00	575,00
L2B 03	77/82	64	C	474,00	551,00
			T	474,00	551,00
			S3	503,00	575,00
			SA	503,00	575,00
L2B 03/S	82/87	69	C	509,00	586,00
			T	509,00	586,00
			S3	539,00	611,00
			SA	539,00	611,00
L2B 04	87/92	74	C	509,00	586,00
			T	509,00	586,00
			S3	539,00	611,00
			SA	539,00	611,00
L2B 04/S	92/97	79	C	509,00	586,00
			T	509,00	586,00
			S3	539,00	611,00
			SA	539,00	611,00
L2B 05	97/102	84	C	523,00	605,00
			T	523,00	605,00
			S3	554,00	636,00
			SA	554,00	636,00
L2B 09	102/107	84	C	523,00	605,00
			T	523,00	605,00
			S3	554,00	636,00
			SA	554,00	636,00
L2B 05/S	107/112	94	C	523,00	605,00
			T	523,00	605,00
			S3	554,00	636,00
			SA	554,00	636,00
L2B 05/S1	112/117	99	C	523,00	605,00
			T	523,00	605,00
			S3	554,00	636,00
			SA	554,00	636,00
L2B 06	117/122	104	C	523,00	605,00
			T	523,00	605,00
			S3	554,00	636,00
			SA	554,00	636,00
L2B 06/S	122/127	109	C	566,00	643,00
			T	566,00	643,00
			S3	600,00	675,00
			SA	600,00	675,00
L2B 07	127/132	114	C	566,00	643,00
			T	566,00	643,00
			S3	600,00	675,00
			SA	600,00	675,00
L2B 07/S	132/137	119	C	566,00	643,00
			T	566,00	643,00
			S3	600,00	675,00
			SA	600,00	675,00
L2B 08	137/142	124	C	566,00	643,00
			T	566,00	643,00
			S3	600,00	675,00
			SA	600,00	675,00

Profilo di tenuta di serie in alluminio da sigillare L 14 x h 10,5 mm.
Issued aluminium profile to seal, 14 mm largex 10,5 mm high.

LIPARI

Porta ad un'anta battente esterna
+ fisso per nicchia
(abbinabile alla parete fissa art. LFL)

Shower door, 1 hinged door + fixed panel in line for
niche (combinable with fixed panel LFL)

CODICE CODE	ESTENSIBILITÀ cm EXTENSIBILITY cm	APERTURA cm OPENING cm	FINITURA LASTRA CRISTALLO 6 mm GLASS 6 mm CRYSTAL	PROFILI - PREZZO € PROFILES - PRICE €	
				BIANCO (BI) WHITE (BI)	ARGENTO LUCIDO (ARL) SILVER POLISH (ARL)
LBFL 01	117/121	65	C	621,00	687,00
			T	621,00	687,00
			S3	656,00	728,00
			SA	656,00	728,00
LBFL 02	122/126	65	C	621,00	687,00
			T	621,00	687,00
			S3	656,00	728,00
			SA	656,00	728,00
LBFL 03	127/131	65	C	656,00	728,00
			T	656,00	728,00
			S3	695,00	771,00
			SA	695,00	771,00
LBFL 04	132/136	65	C	656,00	728,00
			T	656,00	728,00
			S3	695,00	771,00
			SA	695,00	771,00
LBFL 05	137/141	65	C	682,00	754,00
			T	682,00	754,00
			S3	723,00	798,00
			SA	723,00	798,00

- Barra di sostegno 1400 mm
- Cristallo temperato 6 mm

FINITURA LASTRA

- Stampato (C)
- Trasparente (T)
- Satinato (SA)
- Serigrafato (S3)

COLORI PROFILO

- Bianco (BI)
- Argento lucido (ARL)

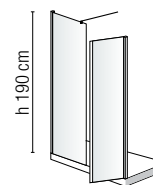

BUONO
GOOD

- Support bar 1400 mm
- Tempered 6 mm crystal

GLASS

- Printed (C)
- Clear (T)
- Glazed (SA)
- Screen printed (S3)

TRIM COLORS

- White (BI)
- Silver polish (ARL)

Dai prezzi sono esclusi:
IVA e spese di trasporto. Per articoli su
misura considerare i prezzi di listino
maggiorati del 40%

Prices do not include: VAT and freight costs.
Custom products +40% on price list.

Indicare la versione sx o dx.
Specify version SX (left) - DX (right).



Indicare il senso di apertura
Indicate the opening direction



Disponibile
su richiesta
a € 135,00
Available
on request
at € 135,00

Possibilità di 1 sola parete fissa da inserire sul lato fisso della porta cod. LFL.
Only 1 fixed side can be coupled and assembled on the fixed door panel cod. LFL.

Profilo di tenuta di serie in alluminio da sigillare L 14 x h 10,5 mm.
Issued aluminium profile to seal, 14 mm largex 10,5 mm high.

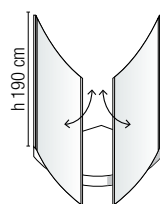

BUONO
GOOD

- Cristallo temperato 6 mm

FINITURA LASTRA

- Stampato (C)
- Trasparente (T)
- Satinato (SA)
- Serigrafato (S3)

COLORI PROFILO

- Bianco (BI)
- Argento lucido (ARL)

- Tempered 6 mm crystal

GLASS

- Printed (C)
- Clear (T)
- Glazed (SA)
- Screen printed (S3)

TRIM COLORS

- White (BI)
- Silver polish (ARL)



Disponibile
su richiesta a
€ 135,00
Available
on request at
€ 135,00

LIPARI

Semicircolare a due ante a battente
Quadrant shower enclosure 2 hinged doors

CODICE CODE	ESTENSIBILITÀ cm EXTENSIBILITY cm	APERTURA cm OPENING cm	FINITURA LASTRA CRISTALLO 6 mm GLASS 6 mm CRYSTAL	PROFILI - PREZZO € PROFILES - PRICE €	
				BIANCO (BI) WHITE (BI)	ARGENTO LUCIDO (ARL) SILVER POLISH (ARL)
LS 04	77/80	67	C	805,00	959,00
			T	805,00	959,00
			S3	-	-
			SA	980,00	1128,00
LS 05	87/90	77	C	841,00	995,00
			T	841,00	995,00
			S3	-	-
			SA	1015,00	1164,00

Dai prezzi sono esclusi: IVA e spese di trasporto. Per articoli su misura considerare i prezzi di listino maggiorati del 40%
Prices do not include: VAT and freight costs.
Custom products +40% on price list.

Non è possibile profilo opzionale in alluminio.
Optional aluminium profile isn't available.

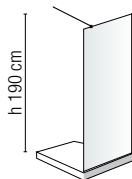

BUONO
GOOD



Disponibile
su richiesta
a € 80,00
Available
on request
at € 80,00

- Parete fissa per Lipari L2B
- Barra di sostegno 1400 mm
- Cristallo temperato 6 mm

FINITURA LASTRA

- Stampato (C)
- Trasparente (T)
- Satinato (SA)
- Serigrafato (S3)

COLORI PROFILO

- Bianco (BI)
- Argento lucido (ARL)

- Fixed screen for Lipari L2B
- Support bar 1400 mm
- Tempered 6 mm crystal

GLASS

- Printed (C)
- Clear (T)
- Glazed (SA)
- Screen printed (S3)

TRIM COLORS

- White (BI)
- Silver polish (ARL)

Dai prezzi sono esclusi:
IVA e spese di trasporto. Per articoli su
misura considerare i prezzi di listino
maggiorati del 40%

Prices do not include: VAT and freight costs.
Custom products +40% on price list.

Indicare la versione sx o dx.
Specify version SX (left) - DX (right).

LIPARI

Parete fissa per L2B Fixed panel for L2B

CODICE CODE	ESTENSIBILITÀ cm EXTENSIBILITY cm	FINITURA LASTRA CRISTALLO 6 mm GLASS 6 mm CRYSTAL	PROFILI - PREZZO € PROFILES - PRICE €	
			BIANCO (BI) WHITE (BI)	ARGENTO LUCIDO (ARL) SILVER POLISH (ARL)
LF 01	66/71	C	347,00	390,00
		T	347,00	390,00
		S3	394,00	438,00
		SA	394,00	438,00
LF 02	71/76	C	347,00	390,00
		T	347,00	390,00
		S3	394,00	438,00
		SA	394,00	438,00
LF 03	76/81	C	347,00	390,00
		T	347,00	390,00
		S3	394,00	438,00
		SA	394,00	438,00
LF 04	81/86	C	364,00	408,00
		T	364,00	408,00
		S3	410,00	456,00
		SA	410,00	456,00
LF 05	86/91	C	364,00	408,00
		T	364,00	408,00
		S3	410,00	456,00
		SA	410,00	456,00
LF 06	91/96	C	364,00	408,00
		T	364,00	408,00
		S3	410,00	456,00
		SA	410,00	456,00
LF 07	96/101	C	388,00	435,00
		T	388,00	435,00
		S3	437,00	482,00
		SA	437,00	482,00
LF 08	101/106	C	388,00	435,00
		T	388,00	435,00
		S3	437,00	482,00
		SA	437,00	482,00
LF 09	106/111	C	388,00	435,00
		T	388,00	435,00
		S3	437,00	482,00
		SA	437,00	482,00
LF 10	111/116	C	426,00	477,00
		T	426,00	477,00
		S3	482,00	523,00
		SA	482,00	523,00
LF 11	116/121	C	426,00	477,00
		T	426,00	477,00
		S3	482,00	523,00
		SA	482,00	523,00

Barra di sostegno con supporti di serie mm.1400

Support bar mm.1400 with supplied support attaches.

Profilo di tenuta di serie in alluminio da sigillare L 14 x h 10,5 mm.

Issued aluminium profile to seal, 14 mm largex 10,5 mm high.

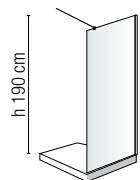

BUONO
GOOD



Disponibile
su richiesta
a € 80,00
Available
on request
at € 80,00

- Parete fissa per Lipari LBF
- Barra di sostegno 1400 mm
- Cristallo temperato 6 mm

FINITURA LASTRA

- Stampato (C)
- Trasparente (T)
- Satinato (SA)
- Serigrafato (S3)

COLORI PROFILO

- Bianco (BI)
- Argento lucido (ARL)

- Fixed screen for Lipari LBF
- Support bar 1400 mm
- Tempered 6 mm crystal

GLASS

- Printed (C)
- Clear (T)
- Glazed (SA)
- Screen printed (S3)

TRIM COLORS

- White (BI)
- Silver polish (ARL)

Dai prezzi sono esclusi:
IVA e spese di trasporto. Per articoli su
misura considerare i prezzi di listino
maggiorati del 40%

Prices do not include: VAT and freight costs.
Custom products +40% on price list.

Indicare la versione sx o dx.
Specify version SX (left) - DX (right).

LIPARI

Parete fissa per LBF Fixed panel for LBF

CODICE CODE	ESTENSIBILITÀ cm EXTENSIBILITY cm	FINITURA LASTRA CRISTALLO 6 mm GLASS 6 mm CRYSTAL	PROFILI - PREZZO € PROFILES - PRICE €	
			BIANCO (BI) WHITE (BI)	ARGENTO LUCIDO (ARL) SILVER POLISH (ARL)
LFF 01	66/86,5	C	267,00	297,00
		T	267,00	297,00
		S3	303,00	333,00
		SA	303,00	333,00
LFF 02	71/73,5	C	267,00	297,00
		T	267,00	297,00
		S3	303,00	333,00
		SA	303,00	333,00
LFF 03	76/78,5	C	267,00	297,00
		T	267,00	297,00
		S3	303,00	333,00
		SA	303,00	333,00
LFF 04	86/88,5	C	282,00	313,00
		T	282,00	313,00
		S3	318,00	349,00
		SA	318,00	349,00
LFF 05	96/98,5	C	282,00	313,00
		T	282,00	313,00
		S3	318,00	349,00
		SA	318,00	349,00
LFF 06	116/118,5	C	282,00	313,00
		T	282,00	313,00
		S3	318,00	349,00
		SA	318,00	349,00

Barra di sostegno con supporti di serie mm.1400
Support bar mm.1400 with supplied support attaches.

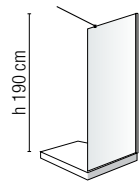

BUONO
GOOD



Disponibile
su richiesta
a € 80,00
Available
on request
at € 80,00

- Parete fissa per Lipari LBFL
- Cristallo temperato 6 mm

FINITURA LASTRA

- Stampato (C)
- Trasparente (T)
- Satinato (SA)
- Serigrafato (S3)

COLORI PROFILO

- Bianco (BI)
- Argento lucido (ARL)

- Fixed screen for Lipari LBFL
- Tempered 6 mm crystal

GLASS

- Printed (C)
- Clear (T)
- Glazed (SA)
- Screen printed (S3)

TRIM COLORS

- White (BI)
- Silver polish (ARL)

Dai prezzi sono esclusi:
IVA e spese di trasporto. Per articoli su
misura considerare i prezzi di listino
maggiorati del 40%

Prices do not include: VAT and freight costs.
Custom products +40% on price list.

Indicare la versione sx o dx.
Specify version SX (left) - DX (right).

LIPARI

Parete fissa per LBFL Fixed panel for LBFL

CODICE CODE	ESTENSIBILITÀ cm EXTENSIBILITY cm	FINITURA LASTRA CRISTALLO 6 mm GLASS 6 mm CRYSTAL	PROFILI - PREZZO € PROFILES - PRICE €	
			BIANCO (BI) WHITE (BI)	ARGENTO LUCIDO (ARL) SILVER POLISH (ARL)
LFL 01	66/71	C	347,00	390,00
		T	347,00	390,00
		S3	394,00	438,00
		SA	394,00	438,00
LFL 02	71/76	C	347,00	390,00
		T	347,00	390,00
		S3	394,00	438,00
		SA	394,00	438,00
LFL 03	76/81	C	347,00	390,00
		T	347,00	390,00
		S3	394,00	438,00
		SA	394,00	438,00

CRETA



- Lato per angolo a due ante battenti
- Porta ad un'anta battente per nicchia apertura esterna
- Porta ad un'anta battente esterna (da abbinare alla parete fissa cod. CFF)
- Semicircolare a due ante battenti apertura esterna
- Parete fissa per CBF

- *Side for corner shower two folding panels*
- *External Leaf door for niche*
- *One external folding door (to compose with fixed side cod. CFF)*
- *Half-round two external folding panels*
- *Fixed screen for CBF*

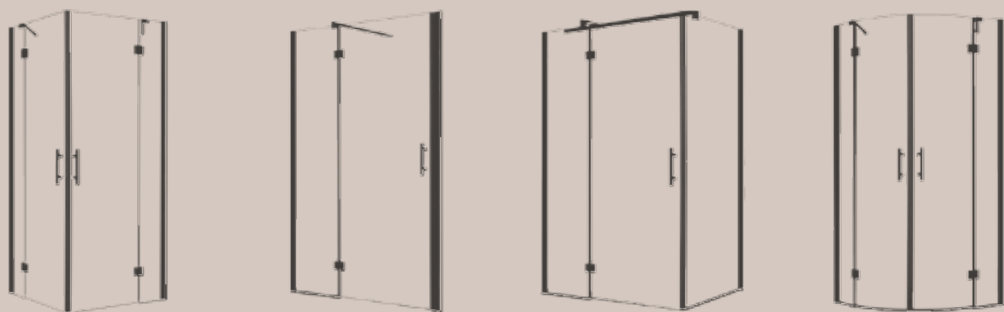







CRETA



BRETTA

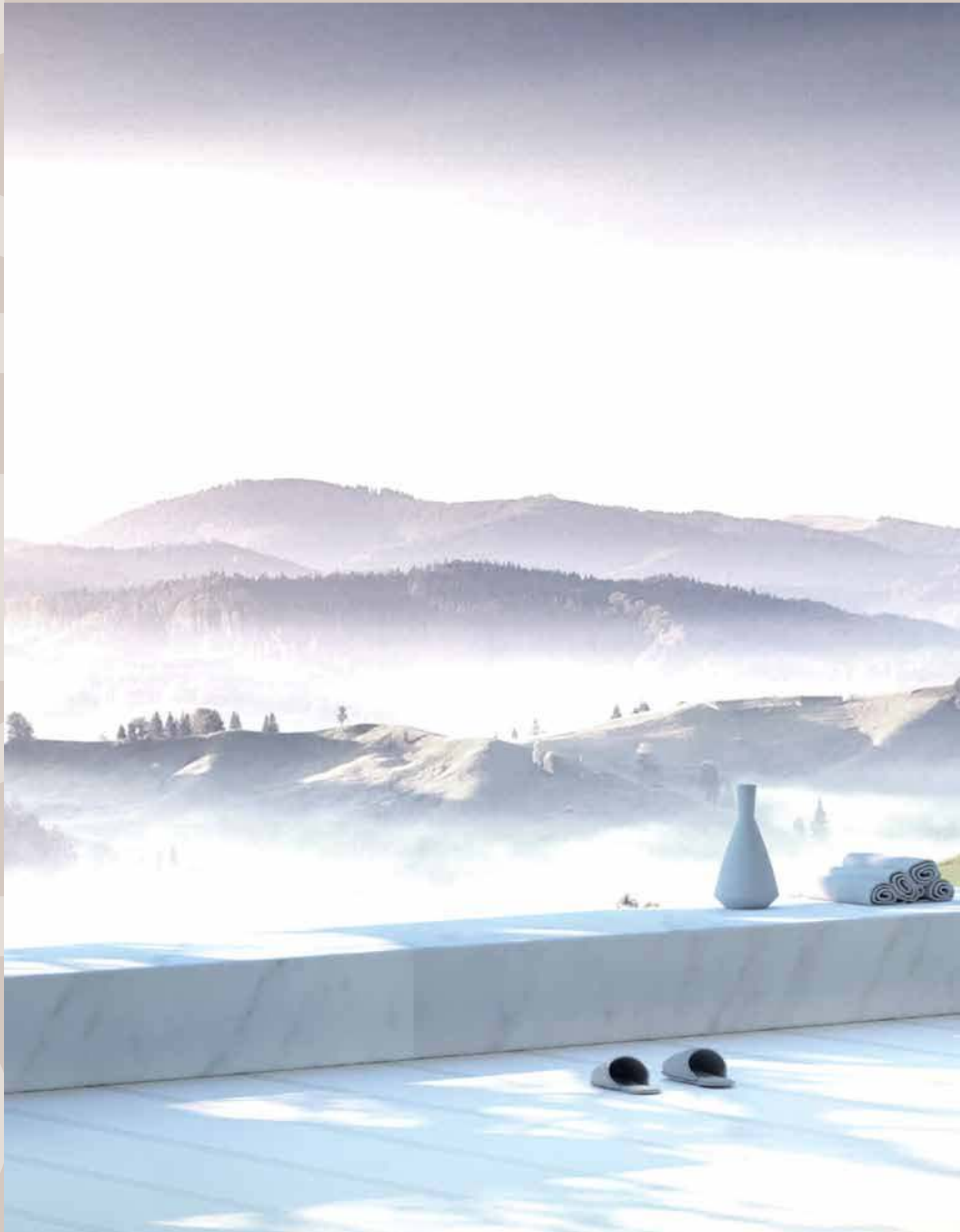



CA 80 CA 120



Profilo di serie

Supplied profiles

L'utilizzo di piatti doccia posati a filo pavimento oppure vasche di dimensioni ridottissime hanno fatto sì di creare un profilo di tenuta di dimensione e conformazione maggiore.

Choosing shower trays in line with the floor or very little baths created the need to bigger watertight profiles

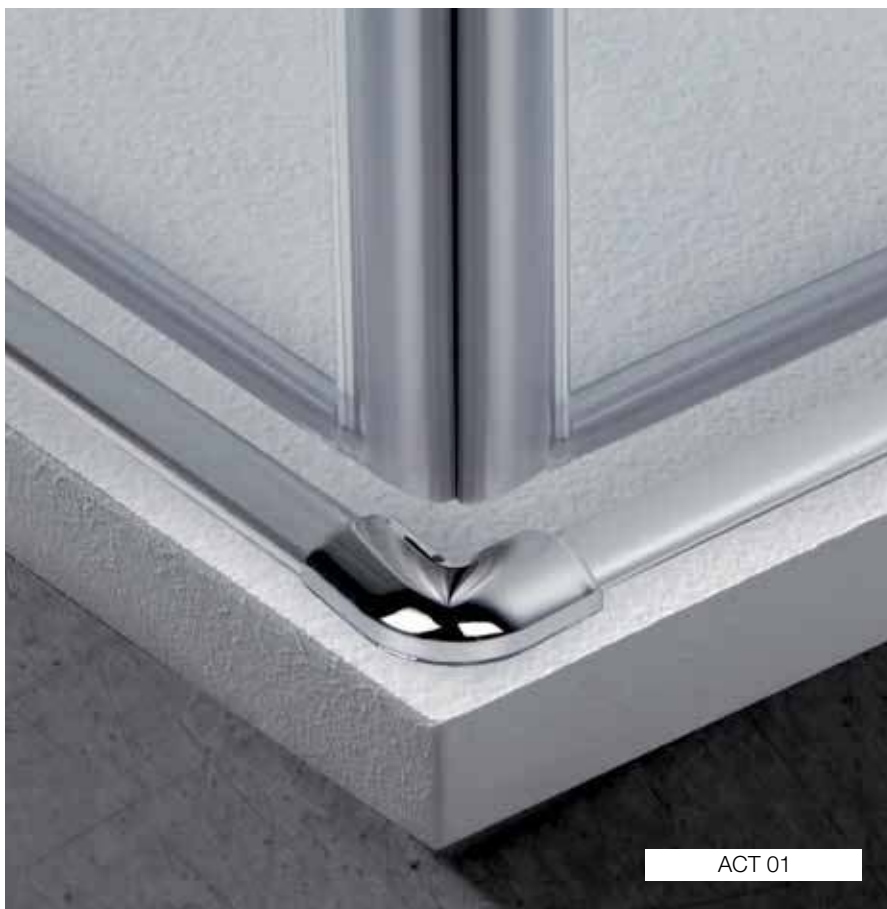

Profilo di serie

Supplied profiles

Attuale e minimale profilo di tenuta supplementare da posizionare sul piatto doccia, dimensione e sistema di fissaggio innovativo nella finitura cromo.

Current and minimal watertight profile to position on the shower tray, innovative dimension and fixing system with chrome finishing.

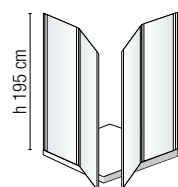

h. 195 cm

- Barra di sostegno
- Cristallo temperato 6 mm

FINITURA LASTRA

- Trasparente (T)
- Grey (GY)

COLORI PROFILO

- Cromo lucido (CR)
- Argento satinato (ARS)



BUONO
GOOD

- Support bar
- Tempered 6 mm crystal

GLASS

- Clear (T)
- Grey (GY)

TRIM COLORS

- Bright chrome (CR)
- Silver satin (ARS)



Versione SX

Versione DX

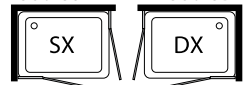

Per piatto doccia rettangolare
indicare se il lato lungo va a sx o a dx
In case of rectangular shower tray indicate
if the long side is on the left or on the right



Disponibile
su richiesta
a € 66,00
Available
on request
at € 66,00

Non disponibile parete fissa.
Fixed screen not available.

CRETA

Lato per angolo a due ante battenti
Side for corner shower two folding panels

CODICE CODE	ESTENSIBILITÀ cm EXTENSIBILITY cm	APERTURA cm* OPENING cm	FINITURA LASTRA CRISTALLO 6 mm GLASS 6 mm CRYSTAL	PROFILI - PREZZO € PROFILES - PRICE €	
				CROMO LUCIDO (CR) BRIGHT CHROME (CR)	ARGENTO SATINATO (ARS) SILVER SATIN (ARS)
CA 70	66,5/69	50	T	440,00	440,00
			GY	487,00	487,00
CA 75	71,5/74	50	T	440,00	440,00
			GY	487,00	487,00
CA 80	76,5/79	60	T	462,00	462,00
			GY	512,00	512,00
CA 90	86,5/89	60	T	484,00	484,00
			GY	536,00	536,00
CA 100	96,5/99	60	T	484,00	484,00
			GY	536,00	536,00
CA 120	116,5/119	60	T	532,00	532,00
			GY	589,00	589,00

*Apertura determinata con due lati della stessa misura.

*Opening is calculated with two sides of the same measure

Dai prezzi sono esclusi: IVA e spese di trasporto. Per articoli su misura considerare i prezzi di listino maggiorati del 40%

Prices do not include: VAT and freight costs.

Custom products +40% on price list.

Profilo di tenuta di serie in alluminio da sigillare L 14 x h 10,5 mm.
Issued aluminium profile to seal, 14 mm largex 10,5 mm high.

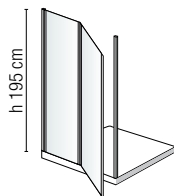

- Barra di sostegno
- Cristallo temperato 6 mm

FINITURA LASTRA

- Trasparente (T)
- Grey (GY)

COLORI PROFILO

- Cromo lucido (CR)
- Argento satinato (ARS)



BUONO
GOOD



Disponibile
su richiesta a € 135,00
Available
on request at € 135,00



Indicare se la porta è a sinistra o a destra
Indicate whether the door is left or right

Dai prezzi sono esclusi: IVA e spese di trasporto. Per articoli su misura considerare i prezzi di listino maggiorati del 40%
Prices do not include: VAT and freight costs.
Custom products +40% on price list.

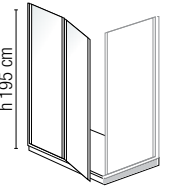

- Barra di sostegno
- Cristallo temperato 6 mm

FINITURA LASTRA

- Trasparente (T)
- Grey (GY)

COLORI PROFILO

- Cromo lucido (CR)
- Argento satinato (ARS)



BUONO
GOOD



Disponibile
su richiesta
a € 106,00
Available
on request
at € 106,00



Indicare se la porta è a sinistra o a destra
Indicate whether the door is left or right

Dai prezzi sono esclusi: IVA e spese di trasporto. Per articoli su misura considerare i prezzi di listino maggiorati del 40%
Prices do not include: VAT and freight costs.
Custom products +40% on price list.

CRETA

Porta ad un'anta per nicchia apertura esterna
External Leaf door for niche

CODICE CODE	ESTENSIBILITÀ cm EXTENSIBILITY cm	APERTURA cm OPENING cm	FINITURA LASTRA CRISTALLO 6 mm GLASS 6 mm CRYSTAL	PROFILO - PREZZO € PROFILES - PRICE €	
				CROMO LUCIDO (CR) BRIGHT CHROME (CR)	ARGENTO SATINATO (ARS) SILVER SATIN (ARS)
CB 03	77/80,5	50	T	768,00	768,00
			GY	872,00	872,00
CB 04	88/90,5	50	T	768,00	768,00
			GY	872,00	872,00
CB 05	98/100,5	50	T	768,00	768,00
			GY	872,00	872,00
CB 06	118/120,5	70	T	806,00	806,00
			GY	914,00	914,00
CB 07	128/130,5	70	T	870,00	870,00
			GY	978,00	978,00
CB 08	138/140,5	70	T	870,00	870,00
			GY	978,00	978,00
CB 09	148/150,5	70	T	914,00	914,00
			GY	1026,00	1026,00
CB 10	168/170,5	70	T	914,00	914,00
			GY	1026,00	1026,00

Profilo di tenuta di serie in alluminio da sigillare L 14 x h 10,5 mm.
Issued aluminium profile to seal, 14 mm largex 10,5 mm high.

CRETA

Porta ad un'anta battente esterna
(da abbinare alla parete fissa cod. CFF)
One external folding door (to compose with fixed side cod. CFF)

CODICE CODE	ESTENSIBILITÀ cm EXTENSIBILITY cm	APERTURA cm OPENING cm	FINITURA LASTRA CRISTALLO 6 mm GLASS 6 mm CRYSTAL	PROFILO - PREZZO € PROFILES - PRICE €	
				CROMO LUCIDO (CR) BRIGHT CHROME (CR)	ARGENTO SATINATO (ARS) SILVER SATIN (ARS)
CBF 01	76,5/79	47	T	768,00	768,00
			GY	871,00	871,00
CBF 02	86,5/89	47	T	768,00	768,00
			GY	871,00	871,00
CBF 03	96,5/99	47	T	768,00	768,00
			GY	871,00	871,00
CBF 04	116,5/119	47	T	806,00	806,00
			GY	914,00	914,00
CBF 05	136,5/139	67	T	870,00	870,00
			GY	978,00	978,00
CBF 06	146,5/149	67	T	870,00	870,00
			GY	978,00	978,00
CBF 07	156,5/159	67	T	914,00	914,00
			GY	1026,00	1026,00
CBF 08	166,5/169	67	T	914,00	914,00
			GY	1026,00	1026,00
CBF 09	176,5/179	67	T	1014,00	1014,00
			GY	1129,00	1129,00
CBF 10	186,5/189	67	T	1014,00	1014,00
			GY	1129,00	1129,00

Profilo di tenuta di serie in alluminio da sigillare L 14 x h 10,5 mm.
Issued aluminium profile to seal, 14 mm largex 10,5 mm high.

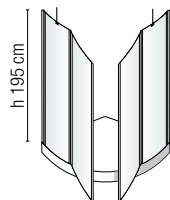

- Barra di sostegno
- Cristallo temperato 6 mm

FINITURA LASTRA

- Trasparente (T)

COLORI PROFILO

- Cromo lucido (CR)
- Argento satinato (ARS)



BUONO
GOOD

- Support bar
- Tempered 6 mm crystal

GLASS

- Clear (T)

TRIM COLORS

- Bright chrome (CR)
- Silver satin (ARS)



Disponibile
su richiesta a € 135,00
Available
on request at € 135,00

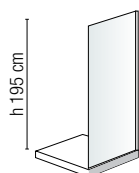
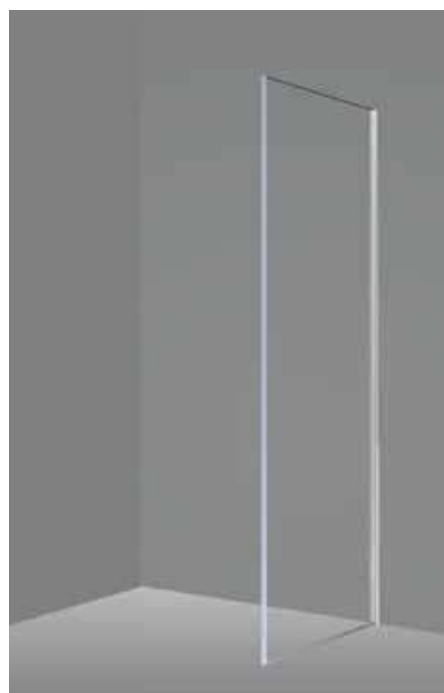

- Cristallo temperato 6 mm

FINITURA LASTRA

- Trasparente (T)
- Grey (GY)
- Specchio trasparente (ST)
- Specchio grey (SGY)

COLORI PROFILO

- Cromo lucido (CR)
- Argento satinato (ARS)



BUONO
GOOD

- Tempered 6 mm crystal

GLASS

- Clear (T)
- Grey (GY)
- Transparent Mirror (ST)
- Grey mirror (SGY)

TRIM COLORS

- Bright chrome (CR)
- Silver satin (ARS)



Finitura cristallo specchio
Mirror glass finishing

Disponibile
su richiesta a € 80,00
Available
on request at € 80,00

CRETA

Semicircolare a due ante battenti
apertura esterna

Half-round two external folding panels

CODICE CODE	ESTENSIBILITÀ cm EXTENSIBILITY cm	APERTURA cm OPENING cm	FINITURA LASTRA CRISTALLO 6 mm GLASS 6 mm CRYSTAL	PROFILI - PREZZO € PROFILES - PRICE €	
				CROMO LUCIDO (CR) BRIGHT CHROME (CR)	ARGENTO SATINATO (ARS) SILVER SATIN (ARS)
CS 04	77,5/80	62	T	1069,00	1069,00
CS 05	87,5/90	62	T	1094,00	1094,00

Di serie profilo di tenuta adesivo in abs L 10 x h 3,5 mm.

Issued Watertight adhesive profile (ABS) 10 mm large x 3,5 mm. high. 10,5 mm high.

Dai prezzi sono esclusi: IVA e spese di trasporto. Non si producono articoli su misura della serie semicircolare.

Prices do not include: VAT and transport costs. Does not produce articles of semi-circular extent of the series.

CRETA

Parete fissa per CBF
Fixed screen for CBF

CODICE CODE	ESTENSIBILITÀ cm EXTENSIBILITY cm	FINITURA LASTRA CRISTALLO 6 mm GLASS 6 mm CRYSTAL	PROFILI - PREZZO € PROFILES - PRICE €	
			CROMO LUCIDO (CR) BRIGHT CHROME (CR)	ARGENTO SATINATO (ARS) SILVER SATIN (ARS)
CFF 01	66,5/69	T	490,00	490,00
		GY	530,00	530,00
		ST	577,00	577,00
		SGY	629,00	629,00
CFF 02	71,5/74	T	490,00	490,00
		GY	530,00	530,00
		ST	577,00	577,00
		SGY	629,00	629,00
CFF 03	76,5/79	T	524,00	524,00
		GY	566,00	566,00
		ST	617,00	617,00
		SGY	672,00	672,00
CFF 04	86,5/89	T	524,00	524,00
		GY	566,00	566,00
		ST	617,00	617,00
		SGY	672,00	672,00
CFF 05	96,5/99	T	524,00	524,00
		GY	566,00	566,00
		ST	617,00	617,00
		SGY	672,00	672,00

Dai prezzi sono esclusi: IVA e spese di trasporto. Per articoli su misura considerare i prezzi di listino maggiorati del 40%

Prices do not include: VAT and freight costs.
Custom products +40% on price list.

MIAMI 4



- Angolo a due ante scorrevoli
- Porta ad un'anta scorrevole e una fissa
- Semicircolare a due ante scorrevoli
- Parete fissa

- *Corner with two sliding doors*
- *Door one sliding screen and a fixed one*
- *Half-round with two sliding doors*
- *Fixed screen*

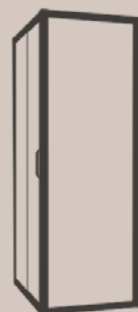



fino a
**TERMINE
SCORTE**



MIA
M14





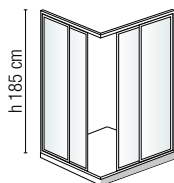

- Scorrimento su cuscinetti a sfera
- Cristallo temperato 4 mm

FINITURA LASTRA

- Stampato (C)
- Trasparente (T)

COLORI PROFILO

- Bianco (BI)
- Argento lucido (ARL)

Abbinabile alla parete fissa MF per formare un box a tre lati



OTTIMO
EXCELLENT

- Slides on ball bearings
- Tempered 4 mm crystal

GLASS

- Printed (C)
- Clear (T)

TRIM COLORS

- White (BI)
- Silver polish (ARL)

Combinabile con parete fissa MF per formare un box a tre lati



Dai prezzi sono esclusi: IVA e spese di trasporto. Per articoli su misura considerare i prezzi di listino maggiorati del 40%

Prices do not include: VAT and freight costs. Custom products +40% on price list.

fino a
**TERMINE
SCORTE**

MIAMI 4

Angolo a due ante scorrevoli
Corner with two sliding doors

CODICE CODE	ESTENSIBILITÀ cm EXTENSIBILITY cm	APERTURA cm OPENING cm	FINITURA LASTRA CRISTALLO 4 mm GLASS CRYSTAL 4 mm	PROFILI - PREZZO € PROFILES - PRICE €	
				BIANCO (BI) WHITE (BI)	ARGENTO LUCIDO (ARL) SILVER POLISH (ARL)
MA 03	68,5/71	39	C	429,00	527,00
			T	429,00	527,00
MA 04	72,5/75	40	C	429,00	527,00
			T	429,00	527,00
MA 05	77,5/80	43	C	435,00	532,00
			T	435,00	532,00
MA 06	87,5/90	50	C	444,00	542,00
			T	444,00	542,00
MA 07	68,5/71 + 87,5/90	44	C	444,00	542,00
			T	444,00	542,00
MA 14	68,5/71 + 98,5/100	49	C	584,00	681,00
			T	584,00	681,00
MA 15	68,5/71 + 117,5/120	53	C	603,00	623,00
			T	603,00	623,00
MA 16	77,5/80 + 117,5/120	60	C	614,00	635,00
			T	614,00	635,00
MA 17	77,5/80 + 98,5/100	53	C	603,00	623,00
			T	603,00	623,00

Imballo in unico collo. Profili orizzontali da assemblare.
One Package, horizontal profiles to be assembled.

fino a
**TERMINE
SCORTE**

MIAMI 4

Porta ad un'anta scorrevole e una fissa
Door one sliding screen and a fixed one

CODICE CODE	ESTENSIBILITÀ cm EXTENSIBILITY cm	APERTURA cm OPENING cm	FINITURA LASTRA CRISTALLO 4 mm GLASS CRYSTAL 4 mm	PROFILI - PREZZO € PROFILES - PRICE €	
				BIANCO (BI) WHITE (BI)	ARGENTO LUCIDO (ARL) SILVER POLISH (ARL)
MPS 06	98/102	39	C	470,00	519,00
			T	470,00	519,00
MPS 07	103/107	43	C	470,00	519,00
			T	470,00	519,00
MPS 08	108/112	48	C	492,00	542,00
			T	492,00	542,00
MPS 09	113/117	50	C	498,00	548,00
			T	498,00	548,00
MPS 10	118/122	50	C	502,00	552,00
			T	502,00	552,00

Installazione rapida. Porta completamente assemblata.
Fast installation. Door completely assembled.

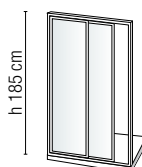

- Scorrimento su cuscinetti a sfera
- Cristallo temperato 4 mm

FINITURA LASTRA

- Stampato (C)
- Trasparente (T)

COLORI PROFILO

- Bianco (BI)
- Argento lucido (ARL)

Abbinabile con il lato fisso MF per trasformarsi in una cabina a due o tre lati



OTTIMO
EXCELLENT

- Slides on ball bearings
- Tempered 4 mm crystal

GLASS

- Printed (C)
- Clear (T)

TRIM COLORS

- White (BI)
- Silver polish (ARL)

Combinabile con parete fissa DF per formare una cabina a due o tre lati



Dai prezzi sono esclusi: IVA e spese di trasporto. Per articoli su misura considerare i prezzi di listino maggiorati del 40%

Prices do not include: VAT and freight costs. Custom products +40% on price list.

fino a
**TERMINE
SCORTE**

MIAMI 4

Semicircolare a due ante scorrevoli
Half-round with two sliding doors

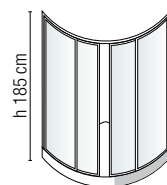

OTTIMO
EXCELLENT

- Scorrimento su cuscinetti a sfera
- FINITURA LASTRA**
- Acrilico:
 - Rugiada
- Cristallo temperato 4 mm:
 - Stampato (C)
 - Trasparente (T)

COLORI PROFILO

- Bianco (BI)
- Argento lucido (ARL)

- Slides on ball bearings

GLASS

- Acrylic:
 - Rugiada
- Tempered 4 mm crystal:
 - Printed (C)
 - Clear (T)

TRIM COLORS

- White (BI)
- Silver polish (ARL)



Dai prezzi sono esclusi:
IVA e spese di trasporto. Non si producono articoli su misura della serie semicircolare.

*Prices do not include: VAT and transport costs.
Does not produce articles of semi-circular extent of the series.*

CODICE CODE	ESTENSIBILITÀ cm EXTENSIBILITY cm	APERTURA cm OPENING cm	FINITURA LASTRA GLASS	PROFILI - PREZZO € PROFILES - PRICE €	
				BIANCO (BI) WHITE (BI)	ARGENTO LUCIDO (ARL) SILVER POLISH (ARL)
MS 01	77,5/80	43		419,00	-
MS 02	87,5/90	51	ACRILICO RUGIADA	429,00	-
MS 03	72,5/75	36		439,00	-
MS 04	77,5/80	43	CRISTALLO 4 mm C	492,00	589,00
			CRISTALLO 4 mm T	492,00	589,00
MS 05	87,5/90	51	CRISTALLO 4 mm C	514,00	606,00
			CRISTALLO 4 mm T	514,00	606,00
MS 06	72,5/75	36	CRISTALLO 4 mm C	510,00	604,00
			CRISTALLO 4 mm T	510,00	604,00
MS 07	67,5/70+87,5/90	48	CRISTALLO 4 mm C	704,00	838,00
			CRISTALLO 4 mm T	704,00	838,00

fino a
**TERMINE
SCORTE**

MIAMI 4

Parete fissa
Fixed screen

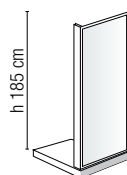

OTTIMO
EXCELLENT

- Parete fissa per Miami 4 MA - MPS
- Cristallo temperato 4 mm

FINITURA LASTRA

- Stampato (C)
- Trasparente (T)

COLORI PROFILO

- Bianco (BI)
- Argento lucido (ARL)

- Fixed screen for Miami 4 MA - MPS
- Tempered 4 mm crystal

GLASS

- Printed (C)
- Clear (T)

TRIM COLORS

- White (BI)
- Silver polish (ARL)



Dai prezzi sono esclusi:
IVA e spese di trasporto. Per articoli su misura considerare i prezzi di listino maggiorati del 40%

*Prices do not include: VAT and freight costs.
Custom products +40% on price list.*

CODICE CODE	ESTENSIBILITÀ cm EXTENSIBILITY cm	FINITURA LASTRA CRISTALLO 4 mm GLASS CRYSTAL 4 mm	PROFILI - PREZZO € PROFILES - PRICE €	
			BIANCO (BI) WHITE (BI)	ARGENTO LUCIDO (ARL) SILVER POLISH (ARL)
MF 03	67/72	C	237,00	331,00
		T	237,00	331,00
MF 04	72/77	C	237,00	331,00
		T	237,00	331,00
MF 05	77/82	C	237,00	331,00
		T	237,00	331,00
MF 06	82/87	C	258,00	362,00
		T	258,00	362,00
MF 07	87/92	C	258,00	362,00
		T	258,00	362,00

SMERALDA

- Angolo a due ante scorrevoli
- Porta a due ante a soffietto
- Porta ad un'anta battente
- Porta ad un'anta scorrevole e una fissa
- Porta a due ante battenti
- Parete fissa

- *Corner with two sliding doors*
- *Shower unit with two accordion doors*
- *Shower unit one folding door*
- *Shower unit one sliding door and a fixed one*
- *Shower unit two folding doors*
- *Fixed screen*

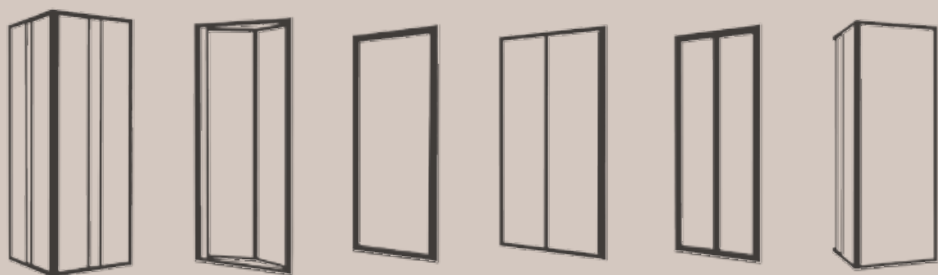



SME
RAL
DA









SZ 08



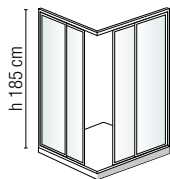

OTTIMO
EXCELLENT



- Scorrimento su pattini in nylon
- FINITURA LASTRA**
- Acrilico:
 - **Bollicine**
- Cristallo temperato 3 mm:
 - **Stampato (C)**
 - **Trasparente (T)**
 - **Serigrafato (S1)**

COLORI PROFILO

- **Bianco (BI)**
- **Argento lucido (ARL)**

Disponibile parete fissa per terzo lato (SF)

· Sliding on nylon blocks

GLASS

Acrylic:

- **Bollicine**

Tempered 3 mm crystal:

- **Printed (C)**
- **Clear (T)**
- **Screen printed (S1)**

TRIM COLORS

- **White (BI)**
- **Silver polish (ARL)**

Available fixed enclosure for third side (SF)

Dai prezzi sono esclusi: IVA e spese di trasporto. Per articoli su misura considerare i prezzi di listino maggiorati del 40%

Prices do not include: VAT and freight costs.
Custom products +40% on price list.

SMERALDA

Porta a due ante a soffietto
Shower unit with two accordion doors

CODICE CODE	ESTENSIBILITÀ cm EXTENSIBILITY cm	APERTURA cm OPENING cm	FINITURA LASTRA GLASS	PROFILI - PREZZO € PROFILES - PRICE €	
				BIANCO (BI) WHITE (BI)	ARGENTO LUCIDO (ARL) SILVER POLISH (ARL)
SS 01/S	63/68	53	ACRILICO/ACRYLIC BOLLICINE	254,00	-
SS 01	68/73	58		254,00	-
SS 02	73/78	63		260,00	-
SS 03	78/83	68		260,00	-
SS 04	83/88	73		264,00	-
SS 05	88/93	78		264,00	-
SS 06	93/98	83		271,00	-
SS 07	98/103	88	271,00	-	
SS 08/S	63/68	53	C	282,00	320,00
			T	282,00	320,00
			S1	310,00	345,00
SS 08	68/73	58	C	282,00	320,00
			T	282,00	320,00
SS 09	73/78	63	S1	310,00	345,00
			C	290,00	329,00
SS 10	78/83	68	T	290,00	329,00
			S1	313,00	350,00
SS 11	83/88	73	C	290,00	329,00
			T	296,00	334,00
SS 12	88/93	78	S1	322,00	355,00
			C	296,00	334,00
SS 13	93/98	83	T	296,00	334,00
			S1	322,00	355,00
SS 14	98/103	88	C	302,00	339,00
			T	302,00	339,00
SS 14	98/103	88	S1	324,00	359,00
			C	304,00	350,00
SS 14	98/103	88	T	304,00	350,00
			S1	336,00	368,00

SMERALDA

Angolo a due ante scorrevoli
Corner with two sliding doors

CODICE CODE	ESTENSIBILITÀ cm EXTENSIBILITY cm	APERTURA cm OPENING cm	FINITURA LASTRA GLASS	PROFILI - PREZZO € PROFILES - PRICE €		
				BIANCO (BI) WHITE (BI)	ARGENTO LUCIDO (ARL) SILVER POLISH (ARL)	
S 01 M	68/80	33/48	ACRILICO/ACRYLIC BOLLICINE	175,00	-	
S 02 M	79/90	40/54		182,00	-	
S 03 M	68/80+79/90	37/51		182,00	-	
S 04 M	64/75	34/48		175,00	-	
S 10 M	68/80+88/100	44/60		210,00	-	
S 12 M	68/80+108/118	44/75		220,00	-	
S 05 M	68/80	33/48		C	236,00	278,00
				T	236,00	278,00
				S1	251,00	292,00
S 06 M	79/90	40/54		C	247,00	285,00
				T	247,00	285,00
S 07 M	68/80+79/90	37/51		S1	262,00	300,00
			C	247,00	285,00	
S 08 M	64/75	34/48	T	247,00	285,00	
			S1	262,00	300,00	
S 14 M	68/80+88/100	44/60	C	236,00	278,00	
			T	251,00	292,00	
S 16 M	68/80+108/118	44/75	S1	320,00	370,00	
			C	320,00	370,00	
S 16 M	68/80+108/118	44/75	T	337,00	385,00	
			S1	331,00	370,00	
S 16 M	68/80+108/118	44/75	T	331,00	370,00	
			S1	348,00	385,00	

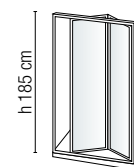

OTTIMO
EXCELLENT

- Scorrimento su cuscinetti a sfera

FINITURA LASTRA

Acrilico:

- **Bollicine**

Cristallo temperato 3 mm:

- **Stampato (C)**
- **Trasparente (T)**
- **Serigrafato (S1)**

COLORI PROFILO

- **Bianco (BI)**
- **Argento lucido (ARL)**

Disponibile parete fissa (SF)
attenzione! L'articolo aumenta di 1,3 cm per lato

· Slides on ball bearings

GLASS

Acrylic:

- **Bollicine**

Tempered 3 mm crystal:

- **Printed (C)**
- **Clear (T)**
- **Screen printed (S1)**

TRIM COLORS

- **White (BI)**
- **Silver polish (ARL)**

Available fixed enclosure (SF)
attention: the article increased of 1,3 cm for every side

Dai prezzi sono esclusi: IVA e spese di trasporto. Per articoli su misura considerare i prezzi di listino maggiorati del 40%

Prices do not include: VAT and freight costs.
Custom products +40% on price list.

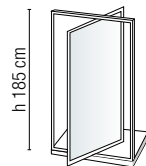
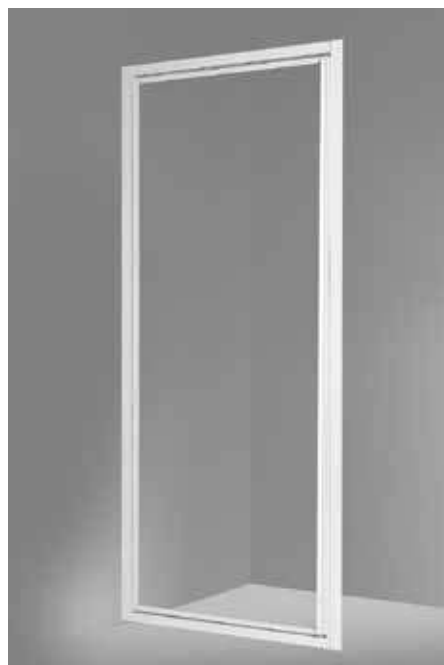

OTTIMO
EXCELLENT



Profili speciali nella sezione profili.
Special profiles in the "profiles" section.

FINITURA LASTRA

Acrilico:
• **Bollicine**

Cristallo temperato 3 mm:
• **Stampato (C)**
• **Trasparente (T)**
• **Serigrafato (S1)**

COLORI PROFILO

• **Bianco (BI)**
• **Argento lucido (ARL)**

Disponibile parete fissa (SF):
attenzione! L'articolo aumenta di 1,3 cm per lato

GLASS

Acrylic:
• **Bollicine**

Tempered 3 mm crystal:
• **Printed (C)**
• **Clear (T)**
• **Screen printed (S1)**

TRIM COLORS

• **White (BI)**
• **Silver polish (ARL)**

Available fixed enclosure (SF):
attention: the article increased of 1,3 cm for every side

SMERALDA

Porta ad un'anta battente
Shower unit one folding door

CODICE CODE	ESTENSIBILITÀ cm EXTENSIBILITY cm	APERTURA cm OPENING cm	FINITURA LASTRA GLASS	PROFILI - PREZZO € PROFILES - PRICE €	
				BIANCO (BI) WHITE (BI)	ARGENTO LUCIDO (ARL) SILVER POLISH (ARL)
SZ 01	68/73	59	ACRILICO/ACRYLIC BOLLICINE	277,00	-
SZ 02	73/78	64		277,00	-
SZ 03	78/83	69		277,00	-
SZ 04/S	83/88	74		287,00	-
SZ 04	88/93	79		287,00	-
SZ 05	68/73	59	C	296,00	360,00
			T	296,00	360,00
			S1	318,00	386,00
SZ 06	73/78	64	C	296,00	360,00
			T	296,00	360,00
			S1	318,00	386,00
SZ 07	78/83	69	C	296,00	360,00
			T	296,00	360,00
			S1	318,00	386,00
SZ 08 / S	83/88	74	C	307,00	373,00
			T	307,00	373,00
			S1	329,00	396,00
SZ 08	88/93	79	C	307,00	373,00
			T	307,00	373,00
			S1	329,00	396,00

Dai prezzi sono esclusi: IVA e spese di trasporto. Per articoli su misura considerare i prezzi di listino maggiorati del 40%
Prices do not include: VAT and freight costs.
Custom products +40% on price list.

SMERALDA

Porta ad un'anta scorrevole e una fissa
Shower unit one sliding door and a fixed one

CODICE CODE	ESTENSIBILITÀ cm EXTENSIBILITY cm	APERTURA cm OPENING cm	FINITURA LASTRA GLASS	PROFILI - PREZZO € PROFILES - PRICE €		
				BIANCO (BI) WHITE (BI)	ARGENTO LUCIDO (ARL) SILVER POLISH (ARL)	
SP 01/S	94/99	41	ACRILICO/ACRYLIC BOLLICINE	240,00	-	
SP 01	100/105	44		240,00	-	
SP 02	106/111	47		244,00	-	
SP 03	112/117	50		244,00	-	
SP 04	118/123	53		250,00	-	
SP 10	124/129	56		262,00	-	
SP 11	130/135	56		262,00	-	
SP 12	136/141	56		268,00	-	
SP 05/S	94/99	41		C	295,00	371,00
				T	295,00	371,00
				S1	315,00	395,00
SP 05	100/105	44		C	295,00	371,00
			T	295,00	371,00	
			S1	315,00	395,00	
SP 06	106/111	47	C	302,00	378,00	
			T	302,00	378,00	
			S1	322,00	402,00	
SP 07	112/117	50	C	302,00	378,00	
			T	302,00	378,00	
			S1	322,00	402,00	
SP 08	118/123	53	C	302,00	378,00	
			T	302,00	378,00	
			S1	322,00	402,00	
SP 14	124/129	56	C	330,00	414,00	
			T	330,00	414,00	
			S1	353,00	442,00	
SP 15	130/135	56	C	330,00	414,00	
			T	330,00	414,00	
			S1	353,00	442,00	
SP 16	136/141	56	C	340,00	424,00	
			T	340,00	424,00	
			S1	363,00	452,00	

• Scorrimento
su pattini in nylon

FINITURA LASTRA

Acrilico:
• **Bollicine**

Cristallo temperato 3 mm:
• **Stampato (C)**
• **Trasparente (T)**
• **Serigrafato (S1)**

COLORI PROFILO

• **Bianco (BI)**
• **Argento lucido (ARL)**

Disponibile parete fissa (SF):
attenzione! L'articolo aumenta di 1,3 cm per lato

• Sliding on nylon blocks

GLASS

Acrylic:
• **Bollicine**

Tempered 3 mm crystal:
• **Printed (C)**
• **Clear (T)**
• **Screen printed (S1)**

TRIM COLORS

• **White (BI)**
• **Silver polish (ARL)**

Available fixed enclosure (SF):
attention: the article increased of 1,3 cm for every side

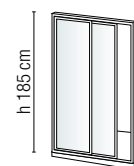

OTTIMO
EXCELLENT

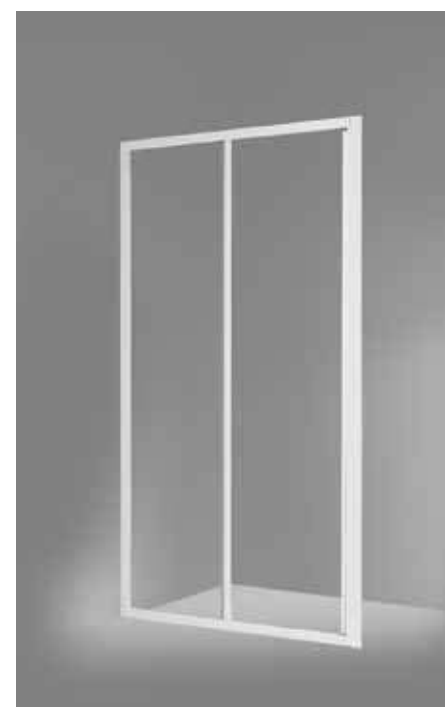

Dai prezzi sono esclusi: IVA e spese di trasporto. Per articoli su misura considerare i prezzi di listino maggiorati del 40%
Prices do not include: VAT and transport costs. For custom orders considering the list prices increased by +40%

SMERALDA

Porta a due ante battenti
Shower unit two folding doors

CODICE CODE	ESTENSIBILITÀ cm EXTENSIBILITY cm	APERTURA cm OPENING cm	FINITURA LASTRA GLASS	PROFILI - PREZZO € PROFILES - PRICE €		
				BIANCO (BI) WHITE (BI)	ARGENTO LUCIDO (ARL) SILVER POLISH (ARL)	
SJ 01	68/73	54	ACRILICO/ACRYLIC BOLLICINE	245,00	-	
SJ 02	73/78	60		245,00	-	
SJ 03	78/83	66		245,00	-	
SJ 04	83/88	68		275,00	-	
SJ 10	88/93	74		275,00	-	
SJ 11	93/98	80		285,00	-	
SJ 12	98/103	84		285,00	-	
SJ 05	68/73	54		C	279,00	374,00
				T	279,00	374,00
				S1	296,00	391,00
SJ 06	73/78	60		C	279,00	374,00
				T	279,00	374,00
			S1	296,00	391,00	
SJ 07	78/83	66	C	279,00	374,00	
			T	279,00	374,00	
			S1	296,00	391,00	
SJ 08	83/88	68	C	334,00	385,00	
			T	334,00	385,00	
			S1	354,00	408,00	
SJ 14	88/93	74	C	334,00	385,00	
			T	334,00	385,00	
			S1	354,00	408,00	
SJ 15	93/98	80	C	334,00	385,00	
			T	334,00	385,00	
			S1	354,00	408,00	
SJ 16	98/103	84	C	334,00	385,00	
			T	334,00	385,00	
			S1	354,00	408,00	

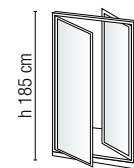
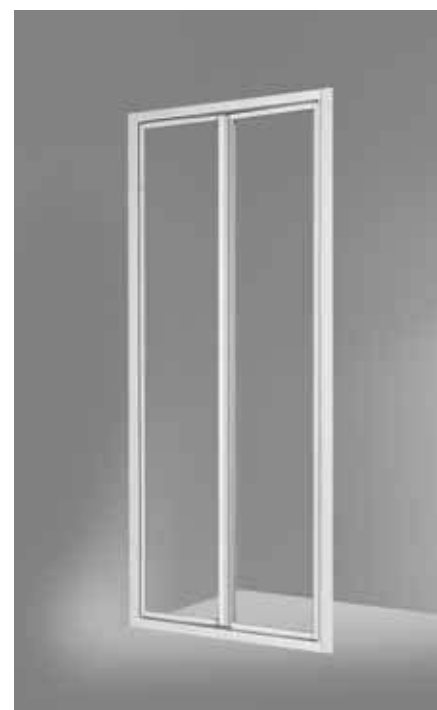

BUONO
GOOD



FINITURA LASTRA

Acrilico:
• **Bollicine**

Cristallo temperato 3 mm:

- Stampato (C)
- Trasparente (T)
- Serigrafato (S1)

COLORI PROFILO

- Bianco (BI)
- Argento lucido (ARL)

Disponibile parete fissa (SF):
attenzione! L'articolo aumenta di 1,3 cm per lato

GLASS

Acrilico:
• **Bollicine**

Tempered 3 mm crystal:

- Printed (C)
- Clear (T)
- Screen printed (S1)

TRIM COLORS

- White (BI)
- Silver polish (ARL)

Available fixed enclosure (SF):
attention: the article increased of 1,3 cm for every side

Dai prezzi sono esclusi: IVA e spese di trasporto. Per articoli su misura considerare i prezzi di listino maggiorati del 40%

Prices do not include: VAT and freight costs.
Custom products +40% on price list.

SMERALDA

Parete fissa
Fixed screen

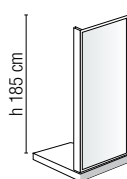

OTTIMO
EXCELLENT



• Parete fissa per Smeralda

FINITURA LASTRA

Acrilico:

- **Bollicine**

Cristallo temperato 3 mm:

- Stampato (C)
- Trasparente (T)
- Serigrafato (S1)

COLORI PROFILO

- Bianco (BI)
- Argento lucido (ARL)

• Fixed screen for Smeralda

GLASS

Acrilico:

- **Bollicine**

Tempered 3 mm crystal:

- Printed (C)
- Clear (T)
- Screen printed (S1)

TRIM COLORS

- White (BI)
- Silver polish (ARL)

CODICE CODE	ESTENSIBILITÀ cm EXTENSIBILITY cm	FINITURA LASTRA GLASS	PROFILI - PREZZO € PROFILES - PRICE €		
			BIANCO (BI) WHITE (BI)	ARGENTO LUCIDO (ARL) SILVER POLISH (ARL)	
SF 01/S	63/67	ACRILICO/ACRYLIC BOLLICINE	111,00	-	
SF 01	68/72		111,00	-	
SF 02	73/77		111,00	-	
SF 03	78/82		117,00	-	
SF 04	83/87		117,00	-	
SF 05	88/92		117,00	-	
SF 06/S	63/67		C	143,00	172,00
			T	143,00	172,00
			S1	167,00	194,00
SF 06	68/72		C	143,00	172,00
		T	143,00	172,00	
		S1	167,00	194,00	
SF 07	73/77	C	143,00	172,00	
		T	143,00	172,00	
		S1	167,00	194,00	
SF 08	78/82	C	150,00	179,00	
		T	150,00	179,00	
		S1	172,00	202,00	
SF 09	83/87	C	155,00	185,00	
		T	155,00	185,00	
		S1	178,00	220,00	
SF 10	88/92	C	155,00	185,00	
		T	155,00	185,00	
		S1	178,00	220,00	

Dai prezzi sono esclusi: IVA e spese di trasporto. Per articoli su misura considerare i prezzi di listino maggiorati del 40%

Prices do not include: VAT and freight costs.
Custom products +40% on price list.

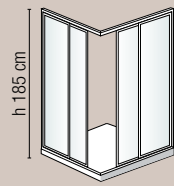
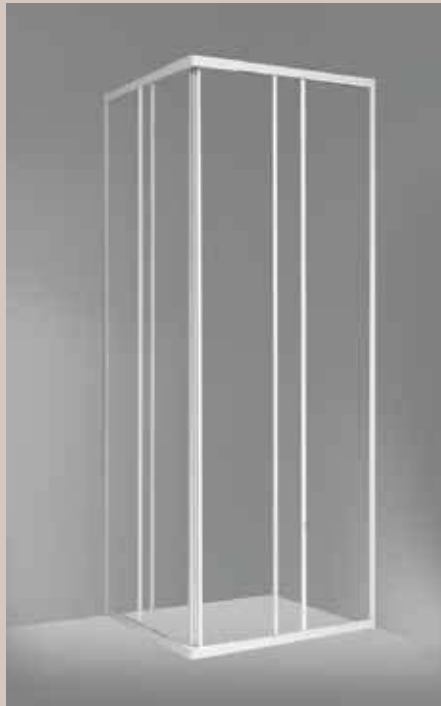

- Scorrimento su pattini in nylon
- Chiusura a labirinto

FINITURA LASTRA

- Acrilico:
- Pioggia

COLORI PROFILO

- Bianco (BI)



OTTIMO
EXCELLENT

- Sliding on nylon blocks
- Closing labyrinth

GLASS

- Acrylic:
- Pioggia

- TRIM COLORS**
- White (BI)



ELBA

Angolo a due ante scorrevoli
Corner with two sliding doors

CODICE CODE	ESTENSIBILITÀ cm EXTENSIBILITY cm	APERTURA cm OPENING cm	FINITURA LASTRA GLASS	PROFILI - PREZZO € PROFILES - PRICE €
				BIANCO (BI) WHITE (BI)
E 01/S	58/68	27/37	ACRILICO/ACRYLIC PIOGGIA	146,00
E 01	68/78	35/47		146,00
E 02	78/88	45/58		156,00
E 03	68/78+78/88	38/52		156,00

Dai prezzi sono esclusi: IVA e spese di trasporto. Per articoli su misura considerare i prezzi di listino maggiorati del 40%
Prices do not include: VAT and freight costs.
Custom products +40% on price list.

Non disponibile parete fissa.
Fixed screen not available.

SOPRA VASCA

- Parete fissa per vasca
- Parete vasca ad un pannello fisso + un'anta apertura esterna
- Parete vasca ad un pannello girevole
- Parete vasca ad un'anta scorrevole ed una fissa
- Parete vasca a due ante scorrevoli e due fisse
- Parete fissa per vasca da abbinare all'art. MVS-MV2S
- Parete vasca da 4 a 7 pannelli pieghevoli
- Parete vasca da 1 a 3 pannelli pieghevoli

- *Fixed bathscreen*
- *Bathscreen one fixed + one external opening*
- *Bathscreen one swivel unit*
- *Bathscreen one sliding and one fixed unit*
- *Bathscreen two sliding doors and two fixed*
- *Fixed panel for tub coupable with MVS-MV2S*
- *Bathscreen from 4 to 7 panels*
- *Bathscreen from 1 to 3 panels*

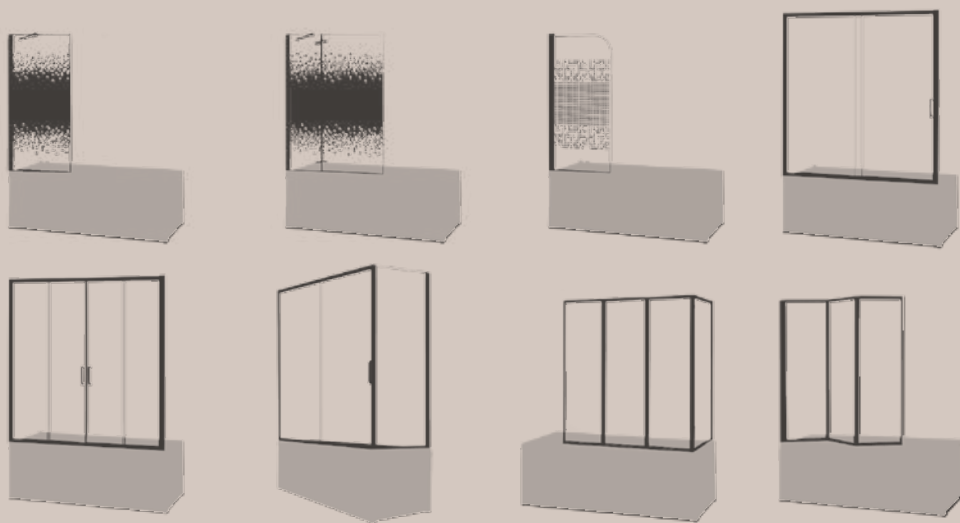



CVFA2 02









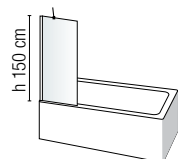

- Barra di sostegno
- Cristallo temperato 6 mm

FINITURA LASTRA

- Trasparente (T)
- Serigrafato (S3)

COLORI PROFILO

- Cromo lucido (CR)



- Support bar
- Tempered 6 mm crystal

GLASS

- Clear (T)
- Screen printed (S3)

TRIM COLORS

- Bright chrome (CR)



Di serie,
compreso
nel prezzo
Standard,
including
in the price

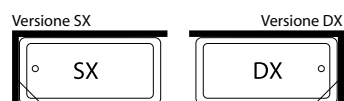

A richiesta porta-salviette L 42 CM € 75,00
On demand towel holder L 42 CM € 75,00

SOPRAVASCA

Parete fissa per vasca
Fixed bathscreen

CODICE CODE	NUMERO ANTE DOORS NUMBERS	ESTENSIBILITÀ cm EXTENSIBILITY cm	FINITURA LASTRA CRISTALLO 6 mm GLASS 6 mm CRYSTAL	PROFILI - PREZZO € PROFILES - PRICE €
				CROMO LUCIDO (CR) BRIGHT CHROME (CR)
CVF 01	1	68/70	T	274,00
			S3	302,00
CVF 02	1	78/80	T	287,00
			S3	317,00
CVF 03	1	83/85	T	302,00
			S3	331,00

Dai prezzi sono esclusi: IVA e spese di trasporto. Per articoli su misura considerare i prezzi di listino maggiorati del +40%

Prices do not include: VAT and freight costs.

Custom products +40% on price list.

Indicare la versione sx o dx.

Specify version SX (left) - DX (right).

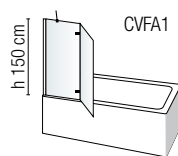

- Barra di sostegno
- Cristallo temperato 6 mm

FINITURA LASTRA

- Trasparente (T)
- Serigrafato (S3)

COLORI PROFILO

- Cromo lucido (CR)

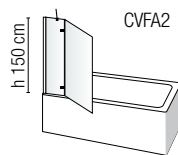

- Support bar
- Tempered 6 mm crystal

GLASS

- Clear (T)
- Screen printed (S3)

TRIM COLORS

- Bright chrome (CR)



Di serie,
compreso
nel prezzo
Standard,
including
in the price

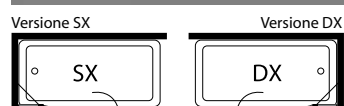

A richiesta porta-salviette L 42 CM € 75,00
On demand towel holder L 42 CM € 75,00

SOPRAVASCA

Parete vasca ad un pannello fisso
+ un'anta apertura esterna
Bathscreen one fixed + one external opening

CODICE CODE	NUMERO ANTE DOORS NUMBERS	ESTENSIBILITÀ cm* EXTENSIBILITY cm	FINITURA LASTRA CRISTALLO 6 mm GLASS 6 mm CRYSTAL	PROFILI - PREZZO € PROFILES - PRICE €
				CROMO LUCIDO (CR) BRIGHT CHROME (CR)
CVFA1 01	2	68/70+30	T	513,00
			S3	550,00
CVFA1 02	2	68/70+40	T	527,00
			S3	566,00
CVFA1 03	2	68/70+50	T	540,00
			S3	579,00
CVFA2 01	2	28/30+66	T	513,00
			S3	550,00
CVFA2 02	2	38/40+66	T	527,00
			S3	566,00
CVFA2 03	2	48/50+66	T	540,00
			S3	579,00

* La prima misura si riferisce alla dimensione del pannello fisso

*First measure refers to fixed panel dimension

Dai prezzi sono esclusi: IVA e spese di trasporto. Per articoli su misura considerare i prezzi di listino maggiorati del +40%

Prices do not include: VAT and freight costs.

Custom products +40% on price list.

Indicare la versione sx o dx.

Specify version SX (left) - DX (right).

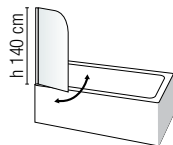

- Anta ripiegabile
- Cristallo temperato 6 mm

FINITURA LASTRA

- Trasparente (T)
- Serigrafato (S1)

COLORI PROFILO

- Bianco (BI)
- Argento lucido (ARL)

- Folding door
- Tempered 6 mm crystal

GLASS

- Clear (T)
- Screen printed (S1)

TRIM COLORS

- White (BI)
- Silver polish (ARL)



Versione SX

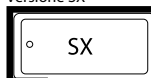

Versione DX

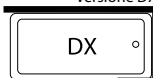

SOPRAVASCA

Parete vasca ad un pannello girevole
Bathscreen one swivel unit

CODICE CODE	NUMERO ANTE DOORS NUMBERS	ESTENSIBILITÀ cm EXTENSIBILITY cm	FINITURA LASTRA CRISTALLO 6 mm GLASS 6 mm CRYSTAL	PROFILO - PREZZO € PROFILES - PRICE €	
				BIANCO (BI) WHITE (BI)	ARGENTO LUCIDO (ARL) SILVER POLISH (ARL)
LV 11	1	70/72	T	228,00	270,00
			S1	285,00	337,00
LV 12	1	80/82	T	239,00	282,00
			S1	299,00	351,00
LV 13	1	83/85	T	245,00	287,00
			S1	305,00	359,00

Dai prezzi sono esclusi: IVA e spese di trasporto. Per articoli su misura considerare i prezzi di listino maggiorati del +40%

Prices do not include: VAT and freight costs.
Custom products +40% on price list.

Indicare la versione sx o dx.
Specify version SX (left) - DX (right).

SOPRAVASCA

Parete vasca ad un'anta scorrevole
ed una fissa
Bathscreen one sliding and one fixed unit

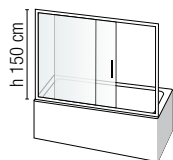

- Scorrimento su cuscinetti a sfera
- Cristallo temperato 4 mm

FINITURA LASTRA

- Trasparente (T)
- Serigrafato (S1)

COLORI PROFILO

- Bianco (BI)
- Argento lucido (ARL)

- Sliding on ball bearings
- Tempered 4 mm crystal

GLASS

- Clear (T)
- Screen printed (S1)

TRIM COLORS

- White (BI)
- Silver polish (ARL)



CODICE CODE	ESTENSIBILITÀ cm EXTENSIBILITY cm	APERTURA cm EXTENSIBILITY cm	FINITURA LASTRA GLASS	PROFILO - PREZZO € PROFILES - PRICE €	
				BIANCO (BI) WHITE (BI)	ARGENTO LUCIDO (ARL) SILVER POLISH (ARL)
MVS 01	150/154	50	T	365,00	427,00
			S1	393,00	450,00
MVS 02	158/162	58	T	365,00	427,00
			S1	393,00	450,00
MVS 03	166/170	66	T	410,00	473,00
			S1	433,00	501,00
MVS 04	176/180	75	T	410,00	473,00
			S1	433,00	501,00

Dai prezzi sono esclusi: IVA e spese di trasporto. Per articoli su misura considerare i prezzi di listino maggiorati del +40%

Prices do not include: VAT and freight costs.
Custom products +40% on price list.



- Scorrimento su cuscinetti a sfera
- Cristallo temperato 4 mm

FINITURA LASTRA

- Trasparente (T)
- Serigrafato (S1)

COLORI PROFILO

- Bianco (BI)
- Argento lucido (ARL)

- Sliding on ball bearings
- Tempered 4 mm crystal

GLASS

- Clear (T)
- Screen printed (S1)

TRIM COLORS

- White (BI)
- Silver polish (ARL)



SOPRAVASCA

Parete vasca a due ante scorrevoli e due fisse

Bathscreen two sliding doors and two fixed

CODICE CODE	ESTENSIBILITÀ cm EXTENSIBILITY cm	APERTURA cm EXTENSIBILITY cm	FINITURA LASTRA GLASS	PROFILI - PREZZO € PROFILES - PRICE €	
				BIANCO (BI) WHITE (BI)	ARGENTO LUCIDO (ARL) SILVER POLISH (ARL)
MV2S 01	150/154	61	T	479,00	536,00
			S1	524,00	582,00
MV2S 02	158/162	62	T	479,00	536,00
			S1	524,00	582,00
MV2S 03	166/170	66	T	536,00	594,00
			S1	582,00	638,00
MV2S 04	176/180	76	T	536,00	594,00
			S1	582,00	638,00

Dai prezzi sono esclusi: IVA e spese di trasporto. Per articoli su misura considerare i prezzi di listino maggiorati del +40%
Prices do not include: VAT and freight costs.
Custom products +40% on price list.

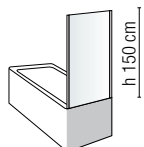

- Cristallo temperato 4 mm

FINITURA LASTRA

- Trasparente (T)
- Serigrafato (S1)

COLORI PROFILO

- Bianco (BI)
- Argento lucido (ARL)

- Tempered 4 mm crystal

GLASS

- Clear (T)
- Screen printed (S1)

TRIM COLORS

- White (BI)
- Silver polish (ARL)



SOPRAVASCA

Parete fissa per vasca da abbinare all'art. MVS-MV2S

Fixed panel for tub coupable with art. MVS-MV2S

CODICE CODE	ESTENSIBILITÀ cm EXTENSIBILITY cm	FINITURA LASTRA GLASS	PROFILI - PREZZO € PROFILES - PRICE €	
			BIANCO (BI) WHITE (BI)	ARGENTO LUCIDO (ARL) SILVER POLISH (ARL)
MVF 01	62/66	T	194,00	228,00
		S1	228,00	262,00
MVF 02	66/70	T	194,00	228,00
		S1	228,00	262,00
MVF 03	76/80	T	211,00	245,00
		S1	245,00	279,00

Dai prezzi sono esclusi: IVA e spese di trasporto. Per articoli su misura considerare i prezzi di listino maggiorati del +40%
Prices do not include: VAT and freight costs.
Custom products +40% on price list.

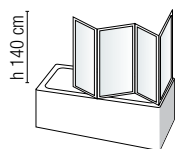

- Ante ripiegabili
- FINITURA LASTRA**
Acrilico:
• **Bollicine**
- COLORI PROFILO**
• **Bianco (BI)**

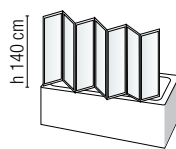

- Folding doors
- GLASS**
Acrylic:
• **Bollicine**
- TRIM COLORS**
• **White (BI)**



SOPRAVASCA

Parete vasca da 4 a 7 pannelli pieghevoli
Bathscreen from 4 to 7 panels

CODICE CODE	NUMERO ANTE DOORS NUMBER	MISURE cm MISURE cm	FINITURA LASTRA GLASS	PROFILI - PREZZO € PROFILES - PRICE €	
				BIANCO (BI) WHITE (BI)	ARGENTO LUCIDO (ARL) SILVER POLISH (ARL)
G 14	1+3	63/64+133	ACRILICO/ACRYLIC BOLLICINE	217,00	-
G 15	1+3	67/68+133		217,00	-
G 05	5	111/112		239,00	-
G 07	7	154/155		251,00	-

Dai prezzi sono esclusi: IVA e spese di trasporto. Per articoli su misura considerare i prezzi di listino maggiorati del +40%
*Prices do not include: VAT and freight costs.
Custom products +40% on price list.*

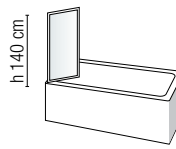

- Ante ripiegabili
- FINITURA LASTRA**
Acrilico:
• **Bollicine**
- Cristallo temperato 3 mm:
• **Stampato (C)**
• **Trasparente (T)**
• **Serigrafato (S1)**
• **Serigrafato (S2)**
- COLORI PROFILO**
• **Bianco (BI)**
• **Argento lucido (ARL)**

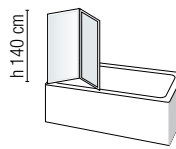

- Folding doors
- GLASS**
Acrylic:
• **Bollicine**
- Tempered 3 mm crystal:
• **Printed (C)**
• **Clear (T)**
• **Screen printed (S1)**
• **Screen printed (S2)**

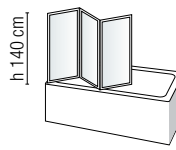

- TRIM COLORS**
• **White (BI)**
• **Silver polish (ARL)**



SOPRAVASCA

Parete vasca da 1 a 3 pannelli pieghevoli
Bathscreen from 1 to 3 panels

CODICE CODE	NUMERO ANTE DOORS NUMBER	MISURE cm MISURE cm	FINITURA LASTRA GLASS	PROFILI - PREZZO € PROFILES - PRICE €		
				BIANCO (BI) WHITE (BI)	ARGENTO LUCIDO (ARL) SILVER POLISH (ARL)	
G 01	1	63/64	ACRILICO/ACRYLIC BOLLICINE	108,00	-	
G 01/68	1	67/68		112,00	-	
G 02	2	90/91		138,00	-	
G 03	3	133/134		164,00	-	
G 13	3	180/181		192,00	-	
G 10	1	63/64		C	141,00	171,00
				T	141,00	171,00
				S1	157,00	187,00
G 10/68	1	67/68		S2	157,00	187,00
				C	146,00	177,00
				T	146,00	177,00
G 12	2	90/91		S1	163,00	195,00
				S2	163,00	195,00
			C	232,00	256,00	
G 11	3	133/134	T	232,00	256,00	
			S1	243,00	263,00	
			S2	243,00	263,00	
G 11	3	133/134	C	287,00	326,00	
			T	287,00	326,00	
			S1	310,00	353,00	
G 11	3	133/134	S2	310,00	353,00	

Dai prezzi sono esclusi: IVA e spese di trasporto. Per articoli su misura considerare i prezzi di listino maggiorati del +40%
*Prices do not include: VAT and freight costs.
Custom products +40% on price list.*

SPECIAL

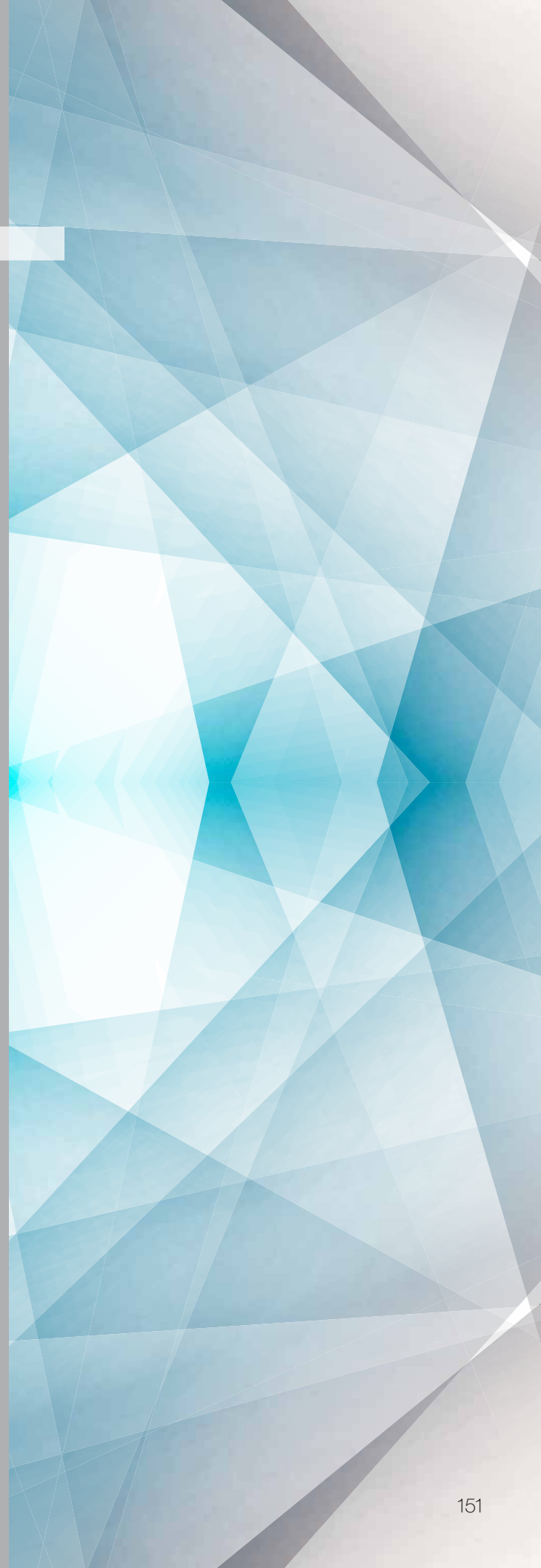

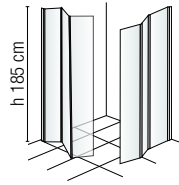

· Ante ripiegabili
FINITURA LASTRA
 Acrilico:
 • **Bollicine**
COLORI PROFILO
 • **Bianco (BI)**

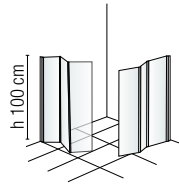

· Folding doors
GLASS
 Acrylic:
 • **Bollicine**
TRIM COLORS
 • **White (BI)**



MEDIO
 MIDDLE



SPECIAL

Angolo a 3+3 pannelli pieghevoli
 Corner with 3+3 folding panels

CODICE CODE	ESTENSIBILITÀ cm EXTENSIBILITY cm	ALTEZZA CABINA CAB HEIGHT	APERTURA cm EXTENSIBILITY cm	FINITURA LASTRA GLASS	PROFILI - PREZZO € PROFILES - PRICE €
					BIANCO (BI) WHITE (BI)
PEC 01	69/70+69/70	CM. 185	TOTALE	ACRILICO/ACRYLIC BOLLICINE	520,00
PEC 02	74/75+74/75				520,00
PEC 03	79/80+79/80				552,00
PEC 04	89/90+89/90				565,00
PEC 05	69/70+89/90				550,00
PEC 06	69/70+99/100				565,00
PEC 27	79/80+99/100	CM.100	TOTALE	ACRILICO/ACRYLIC BOLLICINE	580,00
PEC 28	79/80+119/120				585,00
PEC 01/100	69/70+69/70				469,00
PEC 02/100	74/75+74/75				469,00
PEC 03/100	79/80+79/80				501,00
PEC 04/100	89/90+89/90				514,00
PEC 05/100	69/70+89/90				490,00
PEC 06/100	69/70+99/100				502,00
PEC 27/100	79/80+99/100	520,00			
PEC 28/100	79/80+119/120	530,00			

Dai prezzi sono esclusi: IVA e spese di trasporto. Per articoli su misura considerare i prezzi di listino maggiorati del +30%
 Prices do not include: VAT and transport costs. For custom orders considering the list prices increased by +30%

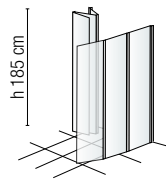

· Ante ripiegabili
FINITURA LASTRA
 Acrilico:
 • **Bollicine**
COLORI PROFILO
 • **Bianco (BI)**

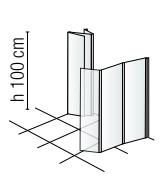

· Folding doors
GLASS
 Acrylic:
 • **Bollicine**
TRIM COLORS
 • **White (BI)**



MEDIO
 MIDDLE



SPECIAL

Tre lati 3+3 pannelli pieghevoli
 Three sides with 3+3 folding panels

CODICE CODE	ESTENSIBILITÀ cm EXTENSIBILITY cm	ALTEZZA CABINA CAB HEIGHT	APERTURA cm EXTENSIBILITY cm	FINITURA LASTRA GLASS	PROFILI - PREZZO € PROFILES - PRICE €
					BIANCO (BI) WHITE (BI)
PEC 07	69/70+69/70	CM. 185	TOTALE	ACRILICO/ACRYLIC BOLLICINE	552,00
PEC 08	74/75+74/75				552,00
PEC 09	79/80+79/80				591,00
PEC 10	89/90+89/90				591,00
PEC 07/100	69/70+69/70	CM.100	TOTALE	ACRILICO/ACRYLIC BOLLICINE	495,00
PEC 08/100	74/75+74/75				495,00
PEC 09/100	79/80+79/80				507,00
PEC 10/100	89/90+89/90				507,00

Dai prezzi sono esclusi: IVA e spese di trasporto. Per articoli su misura considerare i prezzi di listino maggiorati del +30%
 Prices do not include: VAT and transport costs. For custom orders considering the list prices increased by +30%



PEC 03

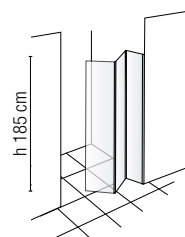

· Ante ripiegabili
FINITURA LASTRA
 Acrilico:
 • Bollicine
COLORI PROFILO
 • Bianco (BI)

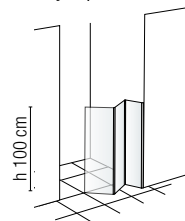

· Folding doors
GLASS
 Acrylic:
 • Bollicine
TRIM COLORS
 • White (BI)



MEDIO
 MIDDLE



SPECIAL

Porta in nicchia 3 pannelli pieghevoli
 Door for hollow space with 3 folding panels

CODICE CODE	ESTENSIBILITÀ cm EXTENSIBILITY cm	ALTEZZA CABINA CAB HEIGHT	APERTURA cm EXTENSIBILITY cm	FINITURA LASTRA GLASS	PROFILI - PREZZO € PROFILES - PRICE €
					BIANCO (BI) WHITE (BI)
PEC 12	68/70	CM. 185	62	ACRILICO/ACRYLIC BOLLICINE	315,00
PEC 13	73/75		67		315,00
PEC 14	78/80		72		322,00
PEC 15	88/90		82		327,00
PEC 16	98/100		92		334,00
PEC 17	118/120		112		340,00
PEC 12/100	68/70		CM.100		62
PEC 13/100	73/75	67			245,00
PEC 14/100	78/80	72			270,00
PEC 15/100	88/90	82			276,00
PEC 16/100	98/100	92			276,00
PEC 17/100	118/120	112			282,00

Dai prezzi sono esclusi: IVA e spese di trasporto. Per articoli su misura considerare i prezzi di listino maggiorati del +30%
 Prices do not include: VAT and transport costs. For custom orders considering the list prices increased by +30%

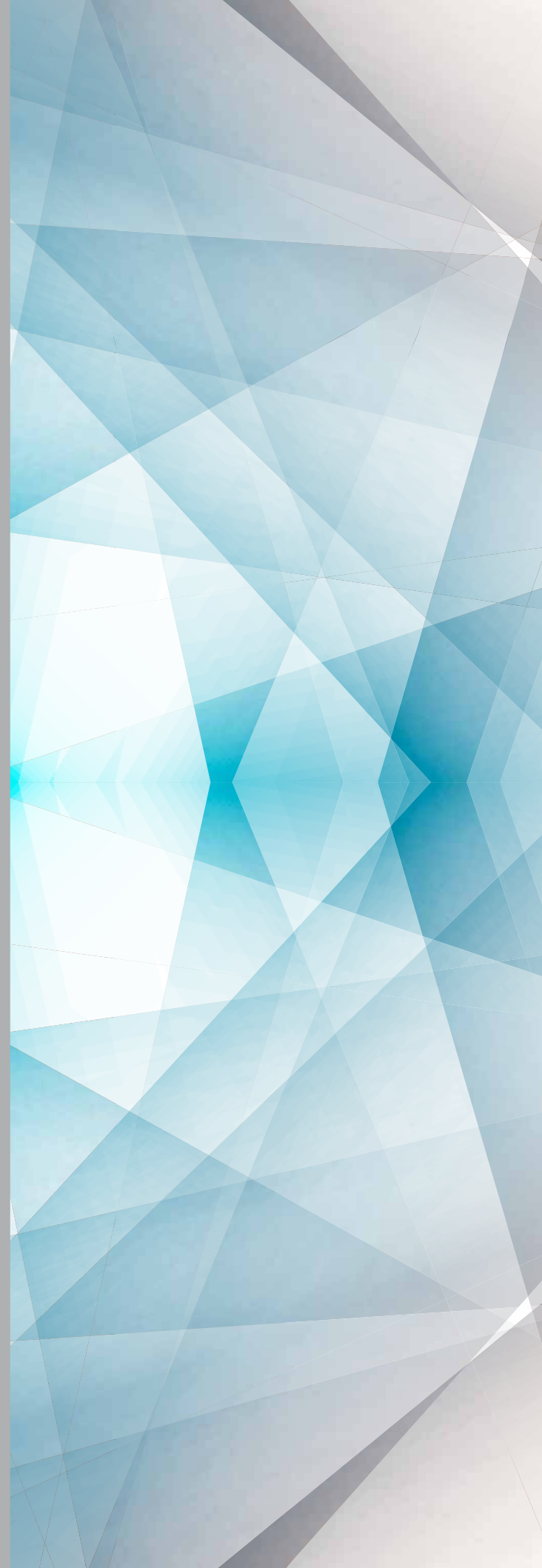
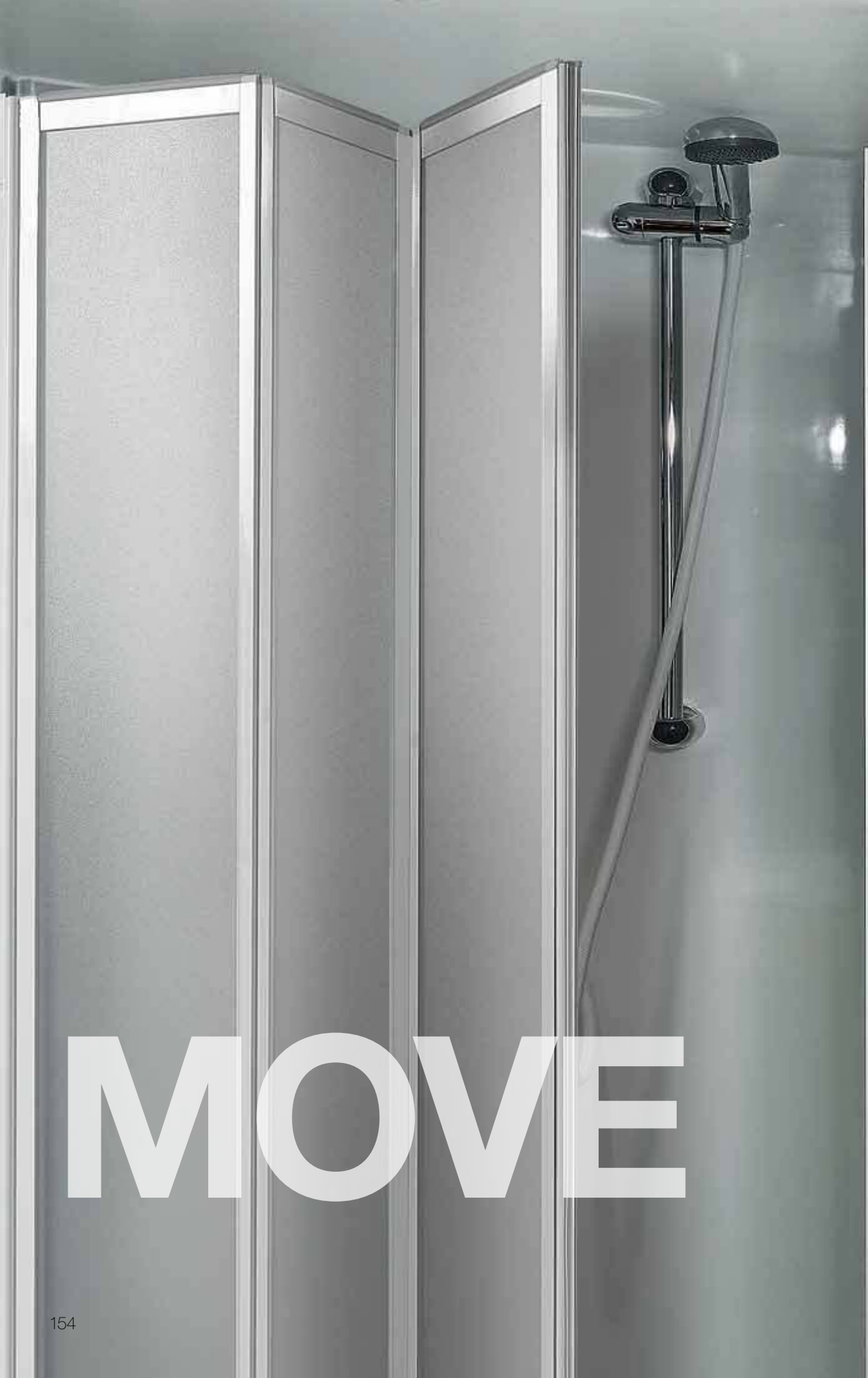

MOVE



Il comfort in movimento per il tuo tempo libero “su misura”.
Movement comfort for your free time “oversized”.





Su misura per te

Customized for you

La linea Move permette di ottimizzare lo spazio e il comfort a bordo, per soddisfare in modo semplice e pratico ogni Vostra esigenza.

Move line allow to optimize space and comfort on board, to satisfy in a simple and practical way all your needs.

PROFILI & RICAMBI

PROFILI

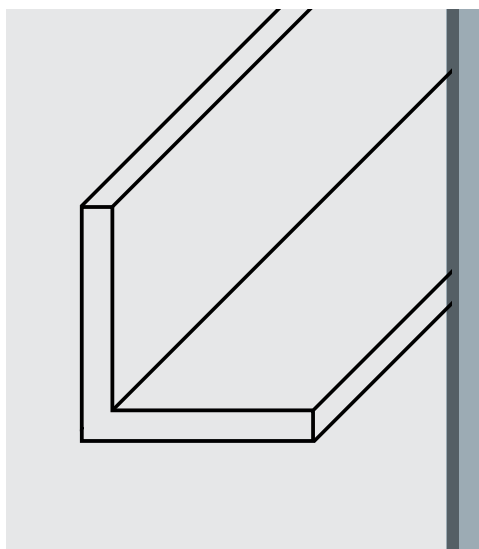
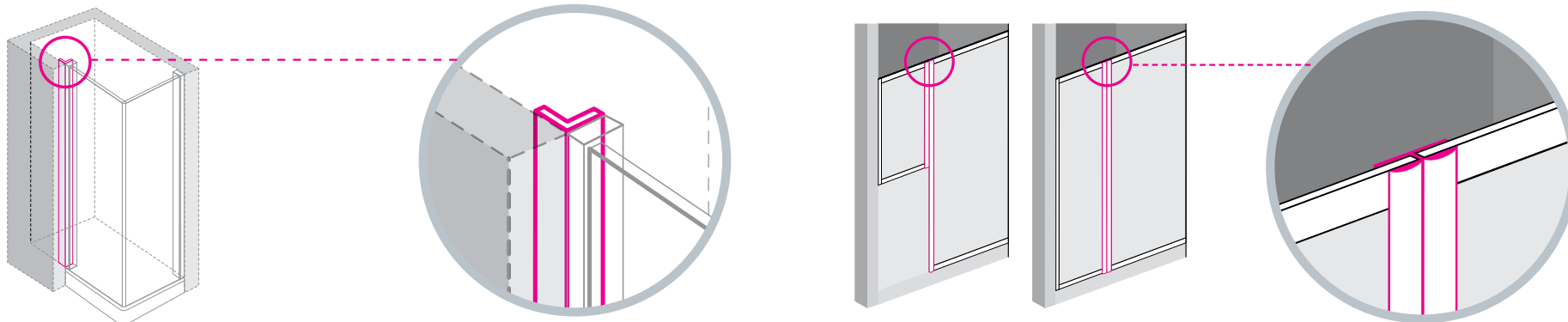

Profilo angolare
Angular profile

CODICE CODE	DIMENSIONI PROFILO DIMENSIONS PROFILE	COMPATIBILE CON SERIE COMPATIBLE WITH SERIES	PROFILI - PREZZO € PROFILES - PRICE €		
			BIANCO (BI) WHITE (BI)	ARGENTO LUCIDO (ARL) SILVER POLISH (ARL)	CROMO LUCIDO (CR) BRIGHT CHROME (CR)
L 01	30x30x195h.	SMERALDA, FIJI, ALICUDI	70,00	78,00	90,00
L 02	40x40x195h.	MIAMI	84,00	90,00	105,00
L 03	50x50x195h.	LIPARI, TONGA, CRETA, DOMINGO, SMERALDA	84,00	90,00	105,00

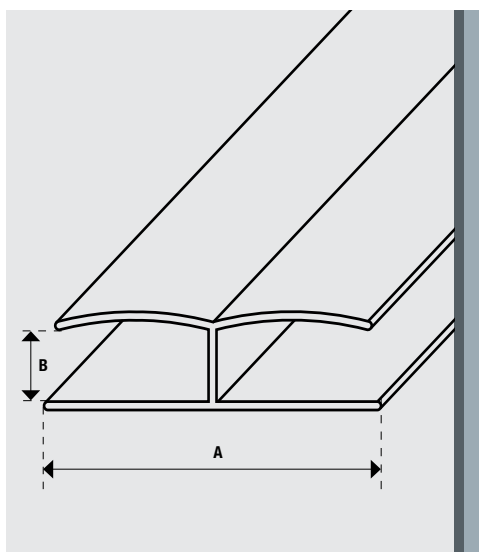

Profilo in linea
Aligned profile

CODICE CODE	DIMENSIONI PROFILO DIMENSIONS PROFILE	COMPATIBILE CON SERIE COMPATIBLE WITH SERIES	PROFILI - PREZZO € PROFILES - PRICE €		
			BIANCO (BI) WHITE (BI)	ARGENTO LUCIDO (ARL) SILVER POLISH (ARL)	CROMO LUCIDO (CR) BRIGHT CHROME (CR)
LI 01	60X13,3X195h.	SMERALDA	60,00	70,00	-
LI 02	60X21X195h.	MIAMI, TONGA, CRETA, DOMINGO, LIPARI	65,00	75,00	82,00

A = 6 cm
B = 1,3 o 2,1 cm

Profilo aggiuntivo per allungamento Additional profile for extension

CODICE CODE	ESTENSIONE MAX MAX EXTENSION	COMPATIBILE CON SERIE COMPATIBLE WITH SERIES	PROFILI - PREZZO € PROFILES - PRICE €		
			BIANCO (B) WHITE (BI)	ARGENTO LUCIDO (ARL) SILVER POLISH (ARL)	CROMO LUCIDO (CR) BRIGHT CHROME (CR)
LA 01	2,5 cm	SMERALDA	105,00	125,00	-

Lunghezza profilo cm.195.
Profile length cm.195.

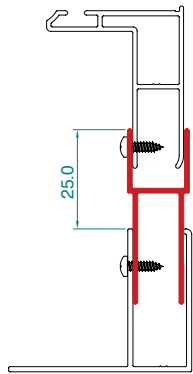

SMERALDA SS
SMERALDA SJ
SMERALDA SZ

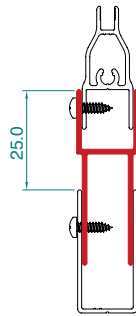

SMERALDA
angolo

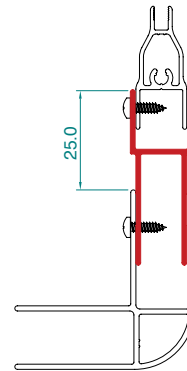

SMERALDA
parete fissa

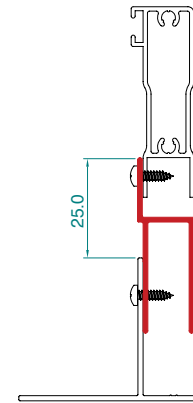

SMERALDA SP

Profilo aggiuntivo per allungamento Additional profile for extension

CODICE CODE	ESTENSIONE MAX MAX EXTENSION	COMPATIBILE CON SERIE COMPATIBLE WITH SERIES	PROFILI - PREZZO € PROFILES - PRICE €		
			BIANCO (BI) WHITE (BI)	ARGENTO LUCIDO (ARL) SILVER POLISH (ARL)	CROMO LUCIDO (CR) BRIGHT CHROME (CR)
LA 02	2,0 cm	TONGA, CRETA, DOMINGO, LIPARI	98,00	120,00	130,00

Lunghezza profilo cm.195.
Profile length cm.195.

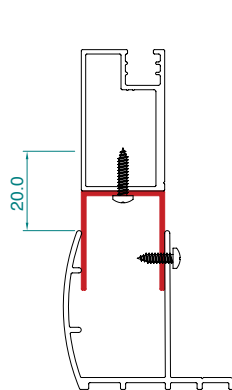

TONGA

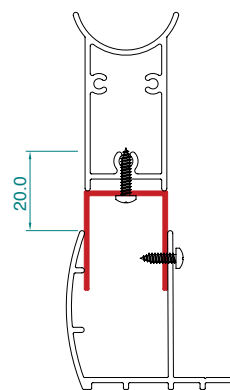

LIPARI

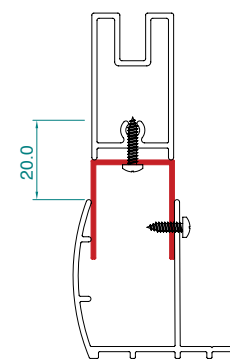

DOMINGO

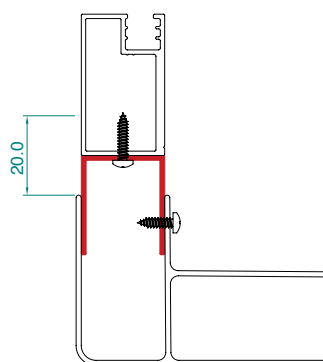

TONGA
in abbinamento con
parete fissa

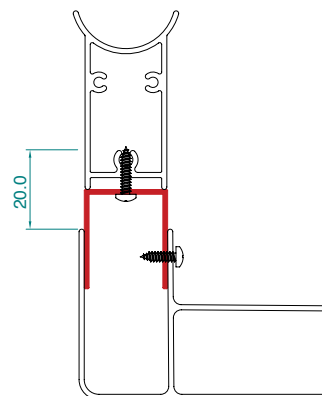

LIPARI
in abbinamento con
parete fissa

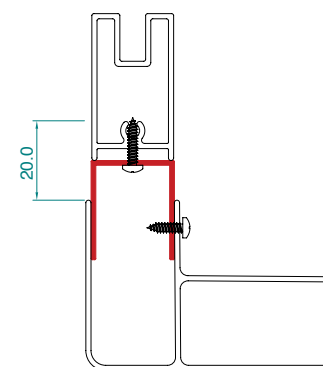

DOMINGO
in abbinamento con
parete fissa

Dimensione profili di compensazione
Wall profile dimension

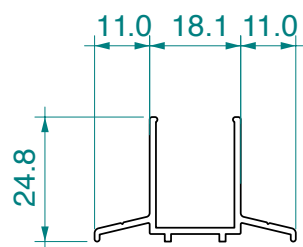

AL001
 Soprasvasca
 Giava

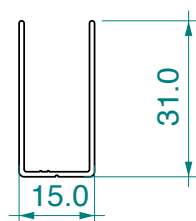

AL008
 Smeralda angoli

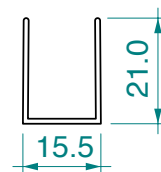

AL016
 Elba

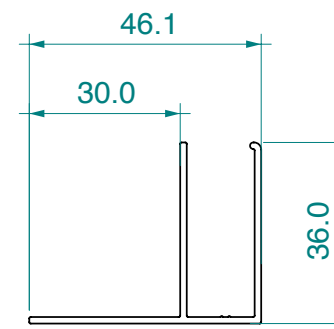

AL027
 Smeralda porte

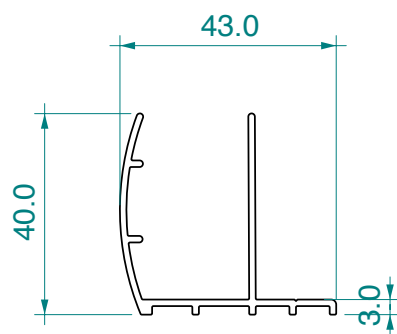

AL028
 Tonga angolo e porte
 Domingo
 Lipari
 Soprasvasca CVF

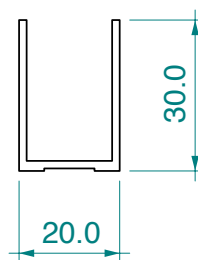

AL105
 Alicudi
 Fiji

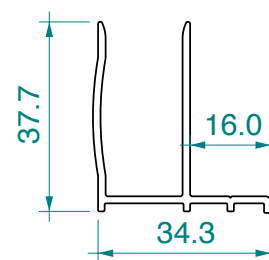

AL046
 Miami
 Soprasvasca
 MVS - MV2S

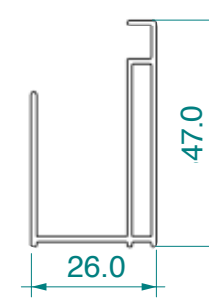

AL051
 Itaca
 Itaca Elite

RICAMBI CABINE DOCCIA

SHOWER BOXED SPARE PARTS

CODICE CODE	DESCRIZIONE DESCRIPTION	PREZZO € PRICE €	RIF. ISTRUZIONE INSTRUCTION REF.	ITACA	ITACA Elite	FJI	ALICUDI	TONGA	DOMINGO	LIPARI	CRETA	MIAMI4	SMERALDA	ELBA
RIC.01	Profilo di tenuta acqua 10x3,5 mm	55,00					X			X	X			
RIC.01PA	Profilo tenuta acqua in alluminio 14x10,5mm +raccordi abs	65,00			X		X			X	X			
RIC.02	guarnizione copricava per smeralda angolo bi	12,00	K										X	
RIC.03	guarnizione copricava per smeralda angolo arl	12,00	k										X	
RIC.04	coppia magneti smeralda angolo bi	25,00											X	
RIC.05	coppia magneti per smeralda angolo arl	25,00											X	
RIC.06	coppia magneti mm.1890 per TA-LBF-LA	32,00	4 TA-3 LBF-3 LA					X		X				
RIC.06PA	coppia magneti mm. 1960 per IA-IAE	32,00	4 IA- IAE	X	X									
RIC.07	coppia magneti mm. 1890 per TP2S-L2B-D2B-TS-LB	32,00	3 L2B-4 LB-7 TS,TP2S	X				X		X				
RIC.07PA	coppia magneti mm. 1960 per IP2S	32,00	7 IP2S	X										
RIC.08	singolo magnete mm. 1890per TPS-DB-DBM	15,00	4 TPS-6 DB					X	X					
RIC.08PA	singolo magnete mm 1960 per IPS	15,00	4 IPS	X										
RIC.09	coppia magneti per MS	32,00	7									X		
RIC.10	coppia magneti per MA	32,00	7									X		
RIC.11	singolo magnete per MPS	15,00	4									X		
RIC.13	coppia magneti per AA	45,00					X							
RIC.18	coppia magneti per CA-CBF	45,00	6 CA-7 CBF								X			
RIC.19	singolo magnete per CB	25,00	7								X			
RIC.20	coppia magneti per CS	35,00	6								X			
RIC.22	raschiavetro verticale mm.1890 Tonga- Itaca-Itaca Elite n 1 profilo	21,00	5 TPS	X	X			X						
RIC.23	raschiavetro verticale Alicudi singolo	21,00					X							
RIC.24	raschiavetro verticale Miami singolo	21,00	6 MA,MS-5 MPS									X		
RIC.25	raschiavetro verticale Creta singolo	21,00	4 CA-4CS								X			
RIC.27	profilo gocciolatoio inferiore Lipari e Domingo	19,00	4 L2B,LA,LBFLS-5 LB,DB						X	X				
RIC.28	profilo gocciolatoio inferiore Creta	19,00	5CA,CS,K2B,KA-6CBF,CB,K2BF,KBF-4KB								X			
RIC.29	profilo a palloncino mm.1950 APS-APSF	23,00												
RIC.29PA	profilo a palloncino mm. 1950 IPSE-IPSE+IFE	23,00	4 IPSE		X									
RIC.30	scorrimento bi per SS kit completo di cuscinetti	45,00											X	
RIC.31	scorrimento arl per SS kit completo di cuscinetti	45,00											X	
RIC.32	scorrimento bi MA-MS kit completo di cuscinetti	45,00	8 (H-I-L-M-N-O)											
RIC.33	scorrimento bi MPS kit completo di cuscinetti	45,00	8 (H-I-L-M-N-O)									X		
RIC.34	scorrimento arl MA-MS kit completo di cuscinetti	48,00	8 (H-I-L-M-N-O)									X		
RIC.35	scorrimento arl MPS kit completo di cuscinetti	48,00	8 (H-I-L-M-N-O)											
RIC.36	profilo di scorrimento mm. 700 inferiore anta Itaca Elite	19,00	8 IAE-IPSE		X									
RIC.37	basetta completa inferiore di aggancio ante Itaca Elite	55,00	0 IAE-IPSE		X									
RIC.38	gancio sicurezza ante Itaca Elite n 2	22,00	M IAE-IPSE		X									
RIC.39	ferma vetro con tappo Itaca-Itaca Elite n 2	18,00	P IA-IAE-IPS-IPSE-IP2S-	X	X									
RIC.40	profilo pvc trasparente x vetro fisso Itaca -Itaca Elite mt. 0,70	29,00	F IPS 08/S-09/S-08-09- F IP2S-N IAE-IPSE-	X	X									
RIC.41	scorrimento SP kit	25,00											X	
RIC.42	scorr. anta TS-TA -TPS-TP2S-IA-IPS-IP2S n 2 carrelli sup n 2 inf.	34,00		X				X						

LEGENDA:
BI=bianco
ARL=argento lucido
CR=cromo lucido

CODICE CODE	DESCRIZIONE DESCRIPTION	PREZZO € PRICE €	RIF. ISTRUZIONE INSTRUCTION REF.	ITACA	ITACA Elite	FJI	ALICUDI	TONGA	DOMINGO	LIPARI	CRETA	MIAMI4	SMERALDA	ELBA
RIC.43	scorrimento anta IAE-IPSE n 2 carrelli superiori	20,00					X							
RIC.45	singolo carrello di scorrimento Alicudi	125,00	7 AA -APS						X					
RIC.46	singola bussola eccentrica antiscambio Alicudi	45,00	8 AA-APS						X					
RIC.46PA	singola bussola fissaggio barra cristallo Alicudi	55,00	9 AA-APS						X					
RIC.46PB	singolo stopper per barra Alicudi	35,00	12 AA-APS						X					
RIC.47	supporto profilo per ACT e scorrimento ante DX	25,00	H AA-APS						X					
RIC.48	supporto profilo per ACT e scorrimento ante SX	25,00	H AA-APS						X					
RIC.49	singolo angolare di giunzione bi S e E	22,00	D										X	X
RIC.50	singolo angolare di giunzione arl S	22,00	D										X	
RIC.51	singolo angolare di giunzione bi TA e MA	32,00	6 TA-9 MA					X				X		
RIC.52	singolo angolare di giunzione cr TA	32,00	6					X						
RIC.53	singolo angolare di giunzione arl MA	32,00	9									X		
RIC.54	singolo angolare di giunzione superiore cr AA	42,00					X							
RIC.55	supporti inferiore+superiore bi Lipari	28,00								X				
RIC.56	supporti inferiore+superiore arl Lipari	28,00								X				
RIC.57	guarnizione fermavetro doppia figura	14,00	G MA-G MS-F IF	X								X		
RIC.58	guarnizione coprifessura MA-MPS	18,00	Q MA									X		
RIC.59	supporto rigido per cristallo lato fisso Miami	5,00	F									X		
RIC.60	singolo perno per apertura bianco	25,00	8-9-10-11						X					
RIC.61	singolo perno per apertura cromo lucido	30,00	8-9-10-11						X					
RIC.63	singola cerniera cromo lucido Creta DX	75,00	8								X			
RIC.64	singola cerniera cromo lucido Creta SX	75,00	8								X			
RIC.65	tappi superiori bi per compensatore e montante n 2+2	25,00						X	X	X	X			
RIC.66	tappi superiori arl per compensatore e montante 2+2	32,00						X	X	X	X			
RIC.67	singolo angolare di giunzione argl IA-IAE	42,00	9 IA-IAE	X	X									
RIC.68	tappi superiori argl per compensatore e montante n 2+2	32,00	G-H	X	X									
RIC.68	tappi superiori argl per raccordo p. fissa IF n 1 dx+1sx	20,00	G- I IF	X										

LEGENDA:
BI=bianco
ARL=argento lucido
CR=cromo lucido

ACCESSORI

ACCESSORIES

CODICE CODE	DESCRIZIONE DESCRIPTION	PREZZO € PRICE €	RIF. ISTRUZIONE INSTRUCTION REF.	ITACA	ITACA Elite	FIJI	ALICUDI	TONGA	DOMINGO	LIPARI	CRETA	MIAMI4	SMERALDA	ELBA
MAN 1	maniglia per SS bianca	15,00	3										X	
MAN 2	maniglia per SS argento lucido	15,00	3										X	
MAN 3	maniglia bianca Tonga ediz. 2013 interasse 160mm	22,00	5 TA-3 TPS-5 TS-6 TP2S					X						
MAN 4	maniglia cromo lucido Tonga ediz. 2015 interasse 160mm	31,00	5 TA-3 TPS-5 TS-6 TP2S					X						
MAN 5	maniglia bianca Lipari interasse 160mm	29,00	5 L2B-5 LA-6 LB-5 LBF-5 LS							X				
MAN 6	maniglia argento lucido Lipari interasse 160mm	35,00	5 L2B-5 LA-6 LB-5 LBF-5 LS							X				
MAN 7	maniglia bianca Miami interasse 125mm	19,00	5 MA-5 MS-3 MPS									X		
MAN 8	maniglia argento lucido Miami intersaae 125mm	22,00	5 MA-5 MS-3 MPS									X		
MAN 9	maniglia bianca Domingo interasse 128mm	29,00	4						X					
MAN 10	maniglia cromo lucido Domingo interassa 128mm	35,00	4						X					
MAN11	maniglia cromo lucido Alicudi interasse 422mm	110,00					X							
MAN12	maniglia arl opzionale per serie lipari interasse 160mm	65,00								X				
MAN14	maniglia cromo lucido Creta interasse 210mm	75,00	8 CB E CBF-7 CS								X			
MAN15	maniglia bianca la coppia per Sj -Sz monoforo	25,00											X	
MAN16	maniglia argento argl completa interasse 210mm	96,00	6	X	X								X	

CODICE CODE	DESCRIZIONE DESCRIPTION	PREZZO € PRICE €	RIF. ISTRUZIONE INSTRUCTION REF.	ITACA	ITACA Elite	FIJI	ALICUDI	TONGA	DOMINGO	LIPARI	CRETA	MIAMI4	SMERALDA	ELBA
RIC.80	portasalviette per fiji	110,00				X								
RIC.81	profilo in alluminio a U 10x10 mm lunghezza 1.500mm	39,00			X	X	X			X				
RIC.81PA	profilo in alluminio a U 10x10 mm lunghezza 2.000mm	45,00	11 IPSE nicchia		X									
RIC.82	barra di sostegno mm1200 Fiji	135,00				X								
RIC.83	barra di sostegno vetro/vetro mm 900 Fiji	105,00				X								
RIC.84	barra di sostegno bianca Lipari completa di attacchi	45,00								X				
RIC.85	barra di sostegno argento lucido Lipari completa di attacchi	55,00								X				
RIC.88	barra di sostegno 45° Creta CA-CS-CV mm 300	84,00									X			
RIC.89	barra di sostegno a T per CBF	210,00									X			
RIC.90	barra di sostegno per CB mm 1200	135,00	10 CB								X			
RIC.91	supporto e fissaggio IFE+IPSE n 3 particolari n 1 +1 viti fissaggio	85,00	9-Q vite brugola-R		X									
RIC.92	supporto e fissaggio IPSE n 2 particolari n 1 +1 viti fissaggio	75,00	9-Q vite autof.3,9x50-R		X									

LEGENDA:
BI=bianco
ARL=argento lucido
CR=cromo lucido

RICAMBI CABINE DOCCIA

SHOWER BOXED SPARE PARTS

CODICE CODE	DESCRIZIONE DESCRIPTION	PREZZO € PRICE €	ITACA	ITACA Elite	FIJI	ALICUDI	TONGA	DOMINGO	LIPARI	CRETA	MIAMI4	SMERALDA	ELBA
KIT.1	montaggio bianco Smeralda e Elba	28,00										X	X
KIT.2	montaggio argento lucido Smeralda	28,00										X	
KIT.3	montaggio bianco SS	28,00										X	
KIT.4	montaggio argento lucido SS	28,00										X	
KIT.5	montaggio bianco SF-MF-TF	20,00					X				X	X	
KIT.6	montaggio argento lucido SF-MF-TF	20,00					X				X	X	
KIT.7	montaggio bianco MA	22,00									X		
KIT.8	montaggio argento lucido MA	22,00									X		
KIT.9	montaggio bianco MS	22,00									X		
KIT.10	montaggio argento lucido MS	22,00									X		
KIT.11	montaggio bianco MPS-TPS	22,00					X				X		
KIT.12	montaggio argento lucido MPS-TPS	22,00					X				X		
KIT.13	montaggio bianco TA	22,00					X						
KIT.14	montaggio cromo lucido TA	26,00					X						
KIT.15	montaggio bianco TS-TP2S	26,00					X						
KIT.16	montaggio cromo lucido TS-TP2S	26,00					X						
KIT.17	montaggio bianco Lipari	24,00							X				
KIT.18	montaggio argento lucido Lipari	24,00							X				
KIT.19	montaggio bianco Domingo	24,00						X					
KIT.20	montaggio cromo lucido Domingo	24,00						X					
KIT.23	montaggio Creta	29,00								X			
KIT.26	montaggio Fiji	30,00			X								
KIT.27	montaggio Alicudi	35,00				X							
KIT.29	montaggio SP	22,00										X	
KIT.30	montaggio SJ	22,00										X	
KIT.31	montaggio IA -IPS-IAE-IPSE	22,00	X	X									
KIT.32	montaggio IF - IFE	22,00	X	X								X	

RICAMBI SOPRAVASCA - SPECIAL - MOVE

TUBE PARTITION SPARE PARTS - SPECIAL - MOVE

CODICE CODE	DESCRIZIONE DESCRIPTION	PREZZO € PRICE €	RIF. ISTRUZIONE INSTRUCTION REF.	GIAVA	CV	LV	MV	SPECIAL	MOVE
RIC.V1	supporti inferiore+superiore bianco	30,00				X			
RIC.V2	supporti inferiore+superiore argento lucido	30,00				X			
RIC.V3	cerniere parete vasca bianco kit	35,00		X				X	X
RIC.V4	cerniere parete vasca argento lucido kit	35,00		X				X	X
RIC.V5	guarnizione di tenuta sottoporta	25,00				X			
RIC.V6	coppia di magneti per MVS	35,00					X		
RIC.V7	coppia di magneti per MV2S	35,00					X		
RIC.V8	guarnizioni raschiavetro lastra da 4mm	28,00					X		
RIC.V9	guarnizione copricava MVS cm 150	18,00					X		
RIC.V10	porta salviette CV	135,00			X				
RIC.V11	kit 1 cerniere CV	110,00			X				
RIC.V12	guarnizione tenuta sottoporta CV	25,00			X				
RIC.V13	profili di tenuta verticale CV	25,00			X				
RIC.V14	barra di sostegno per parete vasca 45° 300mm CV	84,00			X				
RIC.V15	maniglia bianca interasse	15,00						X	X
RIC.V16	maniglia argento lucido	15,00						X	X

RICAMBI PARETI VASCA

TUBE PARTITION SPARE PARTS

CODICE CODE	DESCRIZIONE DESCRIPTION	PREZZO € PRICE €	GIAVA	CV	LV	MV	SPECIAL	MOVE
KIT V.1	montaggio bianco parete vasca G-LV	20,00	X		X			
KIT V.2	montaggio argento lucido parete vasca G-LV	20,00	X		X			
KIT V.3	montaggio bianco pareti Move-Special	20,00					X	X
KIT V.4	montaggio argento lucido pareti Move-Special	20,00					X	X
KIT V.5	montaggio pareti vasca CV	25,00		X				
KIT V.6	montaggio bianco pareti vasca MVS	20,00				X		
KIT V.7	montaggio argento lucido pareti vasca MVS	25,00				X		
KIT V.8	montaggio bianco pareti vasca MV2S	20,00				X		
KIT V.9	montaggio argento lucido pareti vasca MV2S	25,00				X		

LEGENDA:

BI=bianco

ARL=argento lucido

CR=cromo lucido

DIMENSIONI / RAGGIO PIATTI SEMICIRCOLARI

DIMENSIONS / HALF-ROUND TRAYS RAY

DIMENSIONE / RAGGIO DIMENSION / RAY
750x750 R 380 (Disegno 1)
800x800 R 550 (Disegno 2)
900x900 R 550 (Disegno 3)
700x900 R 380 (Disegno 4)

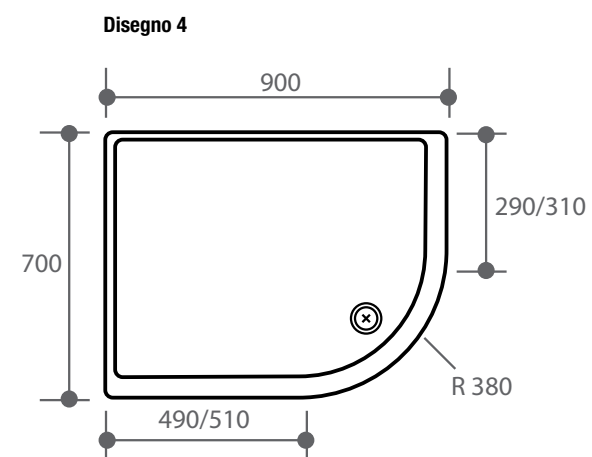
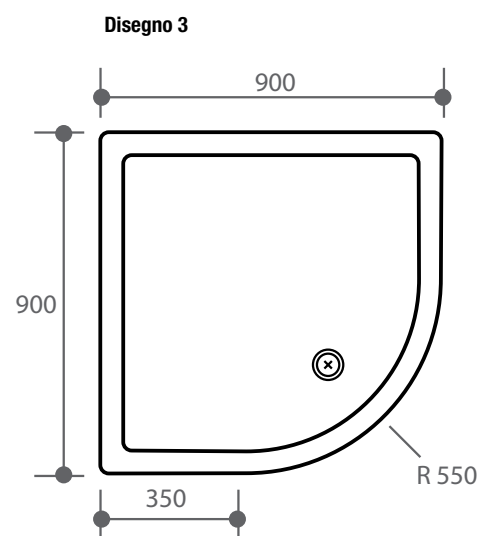
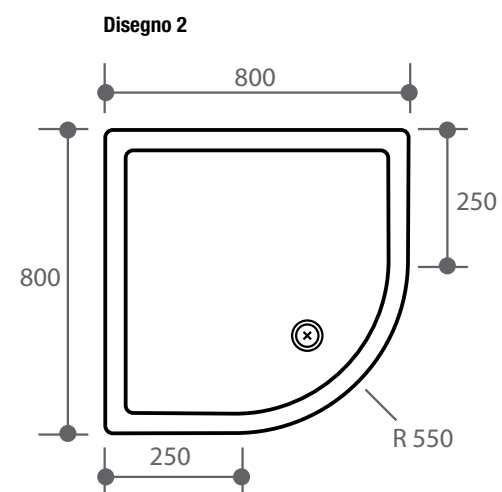
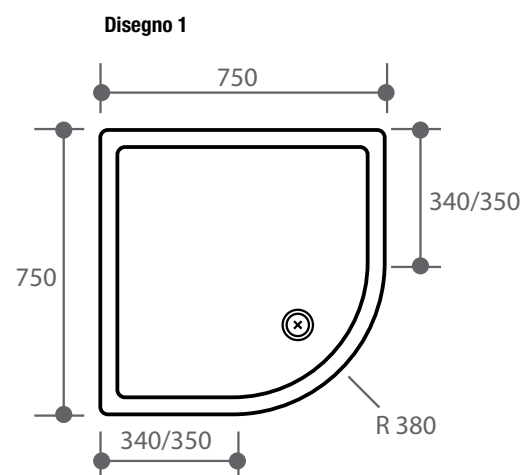

CONDIZIONI GENERALI DI VENDITA 2017

Con l'invio dell'ordine la Committente dichiara di conoscere ed accettare integralmente le seguenti condizioni di vendita.

1

I prezzi di listino si intendono franco nostro deposito, imballo compreso ed al netto dell' I.V.A.

2

Le commissioni, esclusivamente in forma scritta, saranno sempre subordinate alla nostra accettazione.

3

I termini di consegna hanno carattere indicativo e non danno diritto alla Committente di annullare l'ordine, di rifiutare la merce o reclamare danni per la ritardata consegna. Sospensioni totali o parziali delle forniture non daranno diritto ad indennizzi o risarcimenti per qualsivoglia titolo o causa.

4

La merce viaggia a rischio e pericolo della Committente anche se venduta franco destino e non viene assicurata se non per espressa richiesta ed a spese della Committente stessa.

5

Non si accettano reclami trascorso il termine tassativo di 8 (otto) giorni dal ricevimento della merce e la prestazione della garanzia è subordinata alla richiesta scritta del difetto contestato.

6

Eventuali vizi o difetti di qualità della merce da noi accertati e riconosciuti, daranno diritto esclusivamente alla sostituzione dei materiali difettosi, a condizione della loro preventiva ed autorizzata restituzione. La società, inoltre, non riconosce alcun indennizzo per danni subiti dalla Committente e/o da terzi in caso di non corretta installazione e uso delle apparecchiature, incapacità o negligenza dell'utente, manomissione del prodotto, interventi non autorizzati, corrosione ed in genere cause attribuibili agli impianti idrici ed elettrici ed a caso fortuito.

7

Saranno ritenuti validi esclusivamente i pagamenti effettuati presso la nostra sede nei termini indicati in fattura; nella stessa saranno addebitati, nella voce "Spese Varie" le spese di incasso e bollo.

Trascorsi dieci giorni dalla data di scadenza dei termini saremo autorizzati ad emettere tratta a vista per l'intero importo in fattura maggiorato delle spese.

Decorreranno inoltre sulle somme versate fuori termine, gli interessi moratori calcolati nella misura del 5% oltre il tasso ufficiale di sconto.

8

Le vendite vengono effettuate con riserva di proprietà (art. 1523 CC e seg.) pertanto i prodotti rimarranno di esclusiva proprietà della Cosmos S.r.l. sino all'integrale pagamento del prezzo in fattura. I rischi e la custodia del materiale sono assunti dalla Committente dal momento del ritiro e presa in consegna.

9

La Cosmos S.r.l. si riserva il diritto di apportare, in qualunque momento, modifiche tecniche, senza obbligo di preavviso o di sostituzione.

10

Per qualunque controversia sarà competente esclusivamente il foro di Napoli.

Ai sensi e per gli effetti degli art. 1341/1342 CC, la Committente dichiara di aver posto particolare attenzione alla lettura delle clausole sopra riportate e di accettarne e confermarne integralmente il contenuto.

La Direzione





I.A.M.
communication design

www.iam-design.it

Stampa Marzo 2017





COSMOS S.r.l.
VIA DOMENICO BIONDI, 16
80012 CALVIZZANO (NA) ITALY

TEL.: +39 081 713 21 78
FAX: +39 081 184 63 980
WHATS APP: +39 339 46 81 798

INFO@COSMOSDISTRIBUZIONE.IT
WWW.COSMOSDISTRIBUZIONE.IT