



Lo Stile del Benessere



Made in Italy



The logo for AQUAVIVA features a stylized, teal-colored wave or flourish that curves upwards and then downwards, resembling a calligraphic 'A'. To the right of this flourish, the word 'AQUAVIVA' is written in a teal, uppercase, serif font. A registered trademark symbol (®) is located at the end of the word.

The Italian flag is represented by three small, solid-colored squares: a green square on the left, a white square in the middle, and a red square on the right.  
Made in Italy



**COLONNA  
AZZURRA INOX**  
COLUMN

pag. 111



pag. 152

VALVE INOX



Presa acqua  
integrata.  
Integrated  
water supply.

pag. 32

ANDROMEDA

pag. 81

SNELLA



pag. 183

**PACIFICO SUPERIORE**



pag. 182

**PACIFICO INFERIORE**



pag. 180

**MERCURIO**



pag. 198

**QUARZO**



pag. 200

**QUARZO ORIENTABILE**



**SALISCENDI  
SLIM PIÙ**  
SLIDING BAR

pag. 184





pag. 160

QUADRATO  
SQUARE

## BRACCIO DOCCIA LUX CON DEVIATORE

LUX SHOWER ARM  
WITH DIVERTER



pag. 160

TONDO  
ROUND

pag. 165

PARADISO



Possibilità di personalizzare l'altezza dei bracci.  
*Possibility to adjust the height of the arms.*

pag. 165

ARCOBALENO



pag. 236

KIT PRESA ACQUA  
MISCELATRICE



# INDICE

## INDEX

	PAG.
AZIENDA COMPANY	10
ESPOSITORI E PACKAGING DISPLAYS AND PACKAGING	16
CONDIZIONI GENERALI DI VENDITA GENERAL CONDITIONS OF SALE	18
PANNELLI E COLONNE DOCCIA SHOWER PANELS AND COLUMNS	22
WELLNESS & OUTDOOR	100
SOFFIONI E BRACCI DOCCIA SHOWER HEADS AND ARMS	132
SALISCENDI SLIDING BARS	172
DOCCE SHOWERS	218
RUBINETTI E ACCESSORI TAPS AND ACCESSORIES	238





# AZIENDA COMPANY

È con grande soddisfazione e ottimismo che Aquaviva presenta la nuova edizione 2022 del proprio catalogo. Oltre 40 anni di esperienza nello stampaggio e lavorazione delle materie plastiche, una filiera produttiva che va dall'ideazione, progettazione e produzione di nuovi prodotti all'interno delle proprie strutture, permettono oggi ad Aquaviva di presentare una serie di prodotti caratterizzati da un design innovativo che non trascura la funzionalità.

*Aquaviva presents the new edition 2022 of its catalogue with great satisfaction and optimism. Over 40 years of experience in the field of plastics moulding and processing as well as a manufacturing supply chain ranging from conceiving through planning and manufacturing new products in-house allow today Aquaviva to introduce a series of products characterized by innovative design coupled with functionality.*

Aquaviva présente la nouvelle édition 2022 de son catalogue avec grande satisfaction et optimisme. Plus de 40 ans d'expérience dans le domaine du moulage et du traitement des matières plastiques ainsi qu'une chaîne de fabrication constituée par l'idéation, la planification et la fabrication internes de nouveaux produits, permettent aujourd'hui à Aquaviva d'introduire une série de produits caractérisés par un design innovant couplé avec la fonctionnalité.

*Mit grosser Zufriedenheit und Zuversicht präsentiert Aquaviva die neue Ausgabe 2022 ihres Katalogs. Über 40 Jahre Erfahrung im Spritzgiessen und in der Verarbeitung von Kunststoffen, eine Produktionskette von der Konzeption und Planung bis hin zur Herstellung neuer Produkte in den eigenen Werken erlauben heute Aquaviva, eine Reihe von innovativen und zweckmäßigen Produkten vorzustellen.*

Es con mucha satisfacción y optimismo que Aquaviva presenta la nueva edición 2022 de su catálogo. Más de 40 años de experiencia en el moldeado y elaboración de materias plásticas, un proceso productivo que va de la ideación a la proyectación y producción de nuevos productos en su planta, permiten a Aquaviva presentar una serie de productos caracterizados por un diseño innovador y al mismo tiempo funcional.

*Aquaviva представляет новое издание 2022 своего каталога с большим удовлетворением и оптимизмом. Более 40 лет опыта в области литья пластмасс и переработки, а также производственная цепочка, которая идет от проекта до внутреннего производства новых изделий, в сегодняшний день позволяют Aquaviva ввести серию продуктов характеризованных инновационным дизайном в сочетании с функциональностью.*



1.



2.



3.

Ogni processo produttivo è seguito con la massima cura dai tecnici di Aquaviva nel rispetto delle direttive imposte dalle certificazioni di qualità: in particolare la certificazione ISO 9002 per il processo galvanico, certificazione D.M. 174 per verifica alimentari nei prodotti soggetti a passaggio d'acqua e le certificazioni ACS - WRAS - NC - KIWA per la cartuccia termostatica utilizzata nei prodotti.

A completamento della filiera produttiva si aggiungono importanti servizi vendita quali flessibilità nella gestione degli ordini a seconda delle particolari esigenze del cliente, puntualità e serietà nella consegna ed assistenza post-vendita. I risultati sin qui raggiunti, la fedeltà e la soddisfazione dimostrati ogni giorno dai clienti incoraggiano Aquaviva a migliorare la qualità dei prodotti e dei servizi oltre a confermare ed incrementare la presenza di Aquaviva sul mercato.

*Each manufacturing process is followed by Aquavivà technical staff with the utmost care, in compliance with the regulations issued by quality management organizations: in particular, the ISO 9002 certification for the galvanic process, the health certificate according to the Italian ministerial decree no. 174 for food safety and the ACS, WRAS, NC and KIWA certificates for the thermostatic cartridge used in the products.*

*The manufacturing supply chain is completed by important sales services, such as flexibility in processing orders according to the customer's needs, punctuality and seriousness in delivery and customer service. The results achieved so far as well as the loyalty and satisfaction shown every day by its customers encourage Aquaviva to improve the quality of products and services, thereby establishing and increasing its presence on the market.*

1.  
Controllo qualità  
*Quality control*
2.  
Reparto montaggio automatico  
*Automatic fitting shop*
3.  
Stampaggio materie plastiche  
*Plastic materials moulding*
4.  
Panoramica del reparto galvanico  
*A wide-angle shot of the galvanic division*
5.  
Laboratorio chimico galvanica  
*Galvanic chemical laboratory*

4.

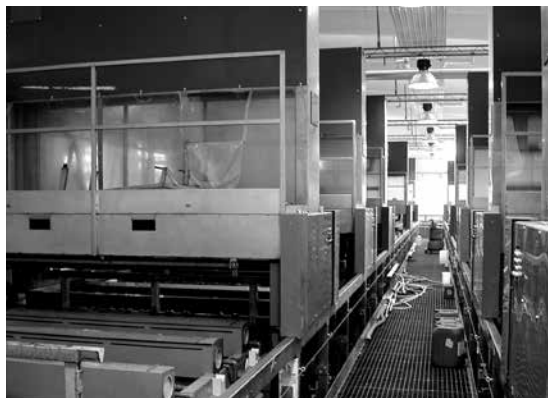

5.

Chaque processus de fabrication est suivi par le personnel technique de Aquaviva avec le plus grand soin, dans le respect des réglementations émises par les organismes de gestion de la qualité: en particulier, la certification ISO 9002 pour le processus galvanique, la certification selon le décret ministériel 174 pour la sécurité alimentaire des produits soumis à passage d'eau, les certifications ACS - WRAS - NC - KIWA pour la cartouche thermostatique utilisée dans les produits.

La chaîne de fabrication est complétée par des services de vente importants, tels que la flexibilité dans la gestion des ordres en fonction des besoins du client, la ponctualité et sérieux dans la gestion des livraisons et du service après-vente.

Les résultats obtenus jusqu'aujourd'hui ainsi que la fidélité et la satisfaction montrées tous les jours par ses clients encouragent Aquaviva à améliorer la qualité des produits et des services, et à confirmer et augmenter la présence d'AQUAVIVA sur le marché.

*Jeder Fertigungsschritt wird sorgfältig vom Aquaviva-Personal nach den Qualitätssicherungsvorgaben der Zertifizierungsstellen gesteuert: insbesondere die ISO 9002-Zertifizierung für den galvanischen Prozess, das Gesundheitszeugnis nach D.M. 174 über die Lebensmittelsicherheit sowie die ACS-, WRAS-, NC- und KIWA-Zertifikate für die thermostatische Patrone, die in den Produkten verwendet wird.*

*Die Produktionskette wird durch wichtige Vertriebsdienstleistungen ergänzt, wie die Flexibilität bei der Auftragsabwicklung nach den jeweiligen Kundenbedürfnissen, die Pünktlichkeit und die Kompetenz bei der Lieferung und den Kundenservice. Die bisher erzielten Ergebnisse, die tägliche Treue und Zufriedenheit ihrer Kunden ermutigen Aquaviva, die Qualität der Produkte und Dienstleistungen zu verbessern und die ihre Präsenz auf dem Markt weiter auszubauen.*

6.



Cada proceso productivo es controlado con gran esmero por los técnicos de Aquaviva siguiendo las directivas impuestas por las certificaciones de calidad: en particular, la certificación ISO 9002 en relación al proceso galvanizado, certificación según el decreto ministerial 174 en relación al control de seguridad en los productos expuestos al paso de agua y las certificaciones ACS - WRAS - NC - KIWA para el cartucho termostático utilizado en los productos.

El proceso productivo incluye también importantes servicios de venta como flexibilidad en la gestión de los pedidos dependiendo de las necesidades particulares de los clientes, puntualidad y seriedad en la entrega y asistencia post-venta. Los resultados conseguidos hasta aquí, la fidelidad y la satisfacción demostradas cada día por los clientes animan Aquaviva a mejorar la calidad de los productos y servicios y incrementar su presencia en el mercado.

7.



*Cada* *Каждый* *производственный* *процесс* *контролирован* *техническим* *персоналом* *Aquaviva* *с* *особой* *тщательностью* *к* *нормативным* *актам* *организации* *управления* *качеством:* *в* *частности,* *ISO* *9002* *для* *гальванических* *процессов,* *сертификат* *здоровья* *в* *соответствии* *с* *итальянским* *министерским* *указом* *174* *по* *безопасности* *пищевых* *продуктов* *и* *ACS,* *WRAS,* *NC,* *KIWA* *сертификаты* *на* *термостатический* *картридж.*

*Производственная* *цепочка* *комплектуется* *с* *важными* *услугами,* *с* *гибкостью* *в* *ведении* *заказов* *в* *соответствии* *с* *потребностями* *клиента,* *с* *пунктуальностью* *и* *серьезностью* *в* *доставках* *и* *обслуживании* *клиентов.*

*Достигнутые* *результаты,* *а* *также* *лояльность* *и* *удовлетворенность,* *проявленные* *каждый* *день* *своими* *клиентами,* *побуждают* *Aquaviva* *улучшать* *качества* *продукции* *и* *услуг,* *тем* *самым* *подтверждают* *ее* *присутствие* *на* *рынке.*

6. Produzione soffioni in ottone  
*Brass head shower production*

7. Banco prova soffioni doccia  
*Head shower testing*

8. Reparto assemblaggio termostabile  
*Packaging department thermostatic valve*

9. Preparazione cromatura  
*Chromium plating setting*

10. Dettaglio assemblaggio cartuccia termostatica  
*Packaging department thermostatic valve close-up shot*

11. Officina realizzazione e riparazione stampi  
*Moulding production and servicing shop*

12. Stampaggio soffioni in ottone e inox  
*Brass and stainless steel head shower moulding*

8.



9.

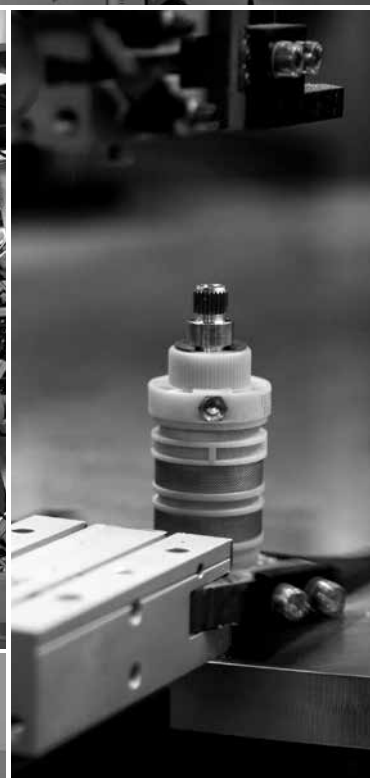

8.

10.



11.

# ESPOSITORI DISPLAYS



VERSIONE ESPOSITORE SINGOLO  
SINGLE DISPLAY VERSION



VERSIONE ESPOSITORE DOPPIO  
DOUBLE DISPLAY VERSION

# PACKAGING



# CONDIZIONI GENERALI DI VENDITA

Con il conferimento dell'ordine il cliente accetta integralmente le condizioni di vendita qui di seguito elencate. Eventuali condizioni generali del compratore non troveranno applicazione nei rapporti futuri fra le parti se non espressamente accettate per iscritto da Aquaviva Srl.

## CONTRATTO

L'invio da parte del compratore di un ordine al venditore comporta l'applicazione al contratto di vendita delle presenti condizioni generali. Il venditore si riserva il diritto di accettare o rifiutare l'ordine ricevuto. Le offerte fatte da agenti, rappresentanti e intermediari nominati dal venditore non sono per lui impegnative fino a quando non siano confermate dal venditore stesso.

## PREZZI

I prezzi indicati nel presente listino si intendono al netto di IVA. Il venditore si riserva di modificare il listino prezzi a cadenza annuale con preavviso.

## RESA DELLA MERCE

I prezzi del presente listino si intendono per merce resa franco nostra fabbrica salvo accordi diversi. Trasporto ed assicurazione sono pertanto a carico del compratore e ciò anche quando sia convenuto che la spedizione o parte di essa venga curata dal venditore, nel qual caso quest'ultimo agirà come mandatario del compratore, essendo inteso che il trasporto verrà effettuato a rischio del compratore. I rischi relativi alla fornitura passano al compratore nel momento in cui i prodotti lasciano lo stabilimento del venditore. Spetta al compratore presentare eventuali reclami al trasportatore, entro due giorni dal ricevimento del materiale, anche se il trasportatore è stato scelto dal venditore.

## TERMINI DI CONSEGNA

I termini di consegna si intendono approssimativi a favore del venditore. È esclusa qualsiasi responsabilità del venditore per danni derivanti da anticipata, ritardata o mancata consegna, totale o parziale. Il termine di consegna verrà prorogato di un periodo pari a quello della durata dell'impedimento al verificarsi di cause di forza maggiore. In nessun caso, a causa del verificarsi di tali circostanze, il compratore potrà esigere compensi o indennizzi di qualsiasi natura.

## GARANZIA

Il venditore garantisce la conformità dei prodotti forniti; con il termine di conformità dei prodotti si intende che essi corrispondono per qualità, quantità e tipo a quanto stabilito nel contratto e che sono esenti da vizi che potrebbero renderli non idonei all'uso a cui sono destinati. La garanzia per vizi è limitata ai soli difetti dei prodotti conseguenti a difetti di progettazione, di materiale o di costruzione riconducibili al venditore, e non si applica nel caso in cui il compratore non provi di aver effettuato una corretta conservazione dei prodotti e di non averli modificati senza il consenso del venditore. Il venditore non risponde dei difetti di conformità dei prodotti dovuti all'usura normale

di quelle parti che per loro natura sono soggette a usura rapida e continua. La garanzia, che ha una durata di anni due, non copre i danni causati da acqua contenente impurità o corpi estranei sia su impianti nuovi che vecchie installazioni calcare.

## RECLAMI

Il compratore è tenuto a verificare la conformità dei prodotti e l'assenza di vizi al ricevimento degli stessi. I reclami relativi a non conformità dei prodotti forniti dovranno essere effettuati, a pena di decadenza, entro otto giorni dal ricevimento della merce. Tutti i reclami dovranno essere effettuati mediante lettera raccomandata, indirizzata al venditore, e devono indicare dettagliatamente i vizi e le non conformità contestate documentandole con foto. Dopo aver autorizzato e ricevuto per verifica il reso a spese e responsabilità del compratore, il venditore, se appurati vizi a sé imputabili o non conformità rispetto a quanto pattuito, procederà nel più breve tempo possibile a fornire gratuitamente franco fabbrica al compratore prodotti dello stesso genere e quantità. In alternativa il venditore si riserva il diritto di emettere una nota di credito a favore del compratore per un importo corrispondente al valore dei prodotti difettosi. Si esclude qualsiasi tipo di risarcimento per interventi, riparazioni o danni diretti o indiretti causati dalla posa in opera di materiale difettoso.

## PAGAMENTI

I pagamenti ed ogni altra somma dovuta a qualsiasi titolo al venditore si intendono netti al suo domicilio. Qualsiasi ritardo o irregolarità nel pagamento dà al venditore il diritto di sospendere le forniture o di risolvere contratti in corso, anche non relativi ai pagamenti in questione, nonché il diritto al risarcimento degli eventuali danni. Il venditore ha altresì il diritto, a decorrere dalla scadenza del pagamento, agli interessi moratori nella misura stabilita in Italia dall'art. 5 del Decreto Legislativo 9 ottobre 2002 n.231. Il ritardo nei pagamenti dà altresì il diritto al venditore di escludere la garanzia per tutto il periodo durante il quale il ritardo perdura. Le contestazioni di qualsiasi natura non danno alcun diritto a ritardare o sospendere i pagamenti.

## RISERVA DI PROPRIETÀ

I prodotti consegnati restano di proprietà del venditore sino al momento del completo pagamento del prezzo.

## LEGGE APPLICABILE E FORO COMPETENTE

Tutti i contratti disciplinati dalle presenti condizioni generali sono regolati dalla legge italiana. Per ogni controversia relativa o comunque collegata ai contratti, cui si applicano le presenti condizioni generali, è esclusivamente competente il foro del venditore, quest'ultimo avrà tuttavia la facoltà di agire presso il foro del compratore.

Aquaviva Srl si riserva il diritto di modificare le caratteristiche dei prodotti senza alcun preavviso, pertanto le immagini e i dati contenuti nel presente catalogo sono da ritenersi indicativi e non costituiscono obbligo di fedele esecuzione.

# GENERAL CONDITIONS OF SALE

*Upon placing the order, the customer fully accepts the following terms and conditions of sale.*

*Any general conditions of the purchaser will not apply to future contractual relations between the parties unless expressly accepted in writing by Aquaviva Srl.*

## CONTRACT

*The purchaser placing the order fully accepts the application of these general terms to the contract for sale. Seller reserves the right to accept or refuse it. Offers made by agents, representatives or auxiliaries of the seller do not bind him until they are confirmed by the seller itself.*

## PRICES

*The prices specified in the current price list do not include VAT. Seller may modify the price list annually with prior notice.*

## SURRENDER OF THE GOODS

*List prices are intended ex works, unless otherwise agreed. Transport and insurance are therefore at the charge of the purchaser, this also when it is decided that the delivery or part of it will be taken care of by seller, in which case the latter will act as the purchaser's agent, it being understood that the transport will be carried out at the expense and risk of the purchaser. The risks relative to the supply pass to the purchaser, at the latest at the time in which the products leave the seller's plant. It's the purchaser in charge of making claims to carrier within 2 days after the receipt of the goods, if even the carrier has been chosen by the seller.*

## DELIVERY TERMS

*The delivery terms are intended approximate in favour of the seller. Any liability of the seller is excluded for damage deriving from anticipated, delayed or non-delivery, total or partial. The time of the delivery performance shall be extended in case of Force Majeure events accordingly to their duration. In any case the purchaser is not entitled to claim damage or compensation.*

## GUARANTEE

*The seller guarantees the compliance of the products supplied; by the term compliance of the products it is meant that they correspond in quality, quantity and type to what was agreed in the contract and that they are without defects that could render them unfit for the use to which they are intended to be put. The guarantee against defects is limited only to products defect due to defects in planning, materials or construction that can be attributed to the seller, and does not apply in the case where the purchaser is unable to prove a correct preservation of the product and where he has modified them without the agreement of the seller. The seller is not liable for defects in product compliance due to the normal wear of those parts which, by nature, are subject to rapid and continuous wear and tear. The guarantee is for a limited*

*period of 2 years and does not cover damages caused by water containing foreign bodies both new and old systems installations.*

## CLAIMS

*The purchaser is required to control the compliance of the products and the absence of flow upon receipt of the goods. Claims relevant to non-conformities of the goods must be made, on pain of forfeiture, within and not later than eight days from the goods arrival at their place of destination and made by registered letter, addressed to the seller, describing in detail the flaws or disputed non-compliances along with some pictures clearly showing the fault. After acceptance of the seller, the purchaser returns for checking the products at his own charge and risk. In case of found faults or manufacturing defects, the seller will only supply ex-factory to the purchaser products of the same kind and quantity as those that proved not in compliance. As alternative the seller may at his discretion issue to the purchaser a credit note for the value of the defective products. It's excluded any refund for direct or indirect damages caused by installation of defective materials.*

## PAYMENTS

*The payment and every other sum due to the seller are understood as net at the registered office of the seller. Any delay or irregularity in the payment gives the seller the right to suspend the supply or to cancel the contract in course, even if they are not relevant to the payments in question, as well as the right to compensation for eventual damages. The seller has also the right, starting from the payment deadline, to interests for delay as per art. 5 of Italian Legislative Decree no.231 of 9 October 2002. The delays of payment likewise give to the seller the right to exclusion from guarantee for the whole period that the delay may persist. Eventual claims do not give to the purchaser the right to delay or do not effect the payments.*

## RETENTION OF TITLE

*The delivered products remain the seller's property until the complete payment is effected.*







## APPLICABLE LAW AND COMPETENT LAW-COURT

*All contrasts ruled by this general conditions are submitted to Italian law. For any controversy relative to or connected to the contractual products to which these general conditions apply, the seller's Law Court has the exclusive competence; the seller, however, has the opportunity to decide to act also in the purchaser's Law Court.*

*Aquaviva Srl reserves the right to modify the characteristics of the products without prior notice, the pictures and the details included in the current catalogue are indicative.*



## FINITURE \_ FINISHING

-  **CR** Cromo | *Chrome*
-  **CO** Cromo/Oro | *Chrome/Gold*
-  **OR** Oro | *Gold*
-  **NS** Nickel Spazzolato | *Satin Nickel*
-  **VO** Vecchio Ottone | *Old Brass*
-  **VR** Vecchio Rame | *Old Copper*
-  **AC** Acrilico | *Acrylic*
-  **IN** Acciaio Inox | *Stainless steel*
-  **BS** Acciaio spazzolato | *Brushed stainless steel*
-  **NE** Nero | *Black*
-  **BI** Bianco | *White*

FINITURE SPECIALI SU RICHIESTA  
SPECIAL FINISHING ON REQUEST

## GETTI \_ JETS

-  Pioggia  
*Rain*
-  Pioggia + Soft  
*Rain + Soft*
-  Nebulizzato  
*Sauna*
-  Soft
-  Pioggia + Idromassaggio  
*Rain + Hydromassage*
-  Aerato  
*Aerated*
-  Idromassaggio  
*Hydromassage*
-  Pioggia + Vapore  
*Rain + Vapor*
-  Pioggia + Aerato  
*Rain + Aerated*
-  Cascata  
*Cascade*
-  Spin
-  Idroscopino  
*Shut-off*

## LEGENDA \_ LEGEND



Confezione in scatola  
*Packed in carton box*



Confezione in scatola litografata  
*Packed in lithographic box*



Confezione in scatola con finestra  
*Packed in box with window*



Confezione in sacchetto appendibile  
*Polybag packaging*



Prodotto ispezionabile  
*Inspectionable product*



Materiale  
*Material*

# PANNELLI E COLONNE DOCCIA

## SHOWER PANELS AND COLUMNS

FINITURE SPECIALI SU RICHIESTA:  
SPECIAL FINISHING ON REQUEST:

-  **OR** Oro | Gold
-  **VO** Vecchio Ottone | Old Brass
-  **VR** Vecchio Rame | Old Copper
-  **NS** Nickel Spazzolato | Satin Nickel
-  **NE** Nero | Black
-  **BI** Bianco | White

Sugli articoli in finitura speciale si potrebbero presentare delle imperfezioni, dovute al tipo di lavorazione.  
*Please kindly note that on items in special finishing you may have imperfections due to the type of machining.*









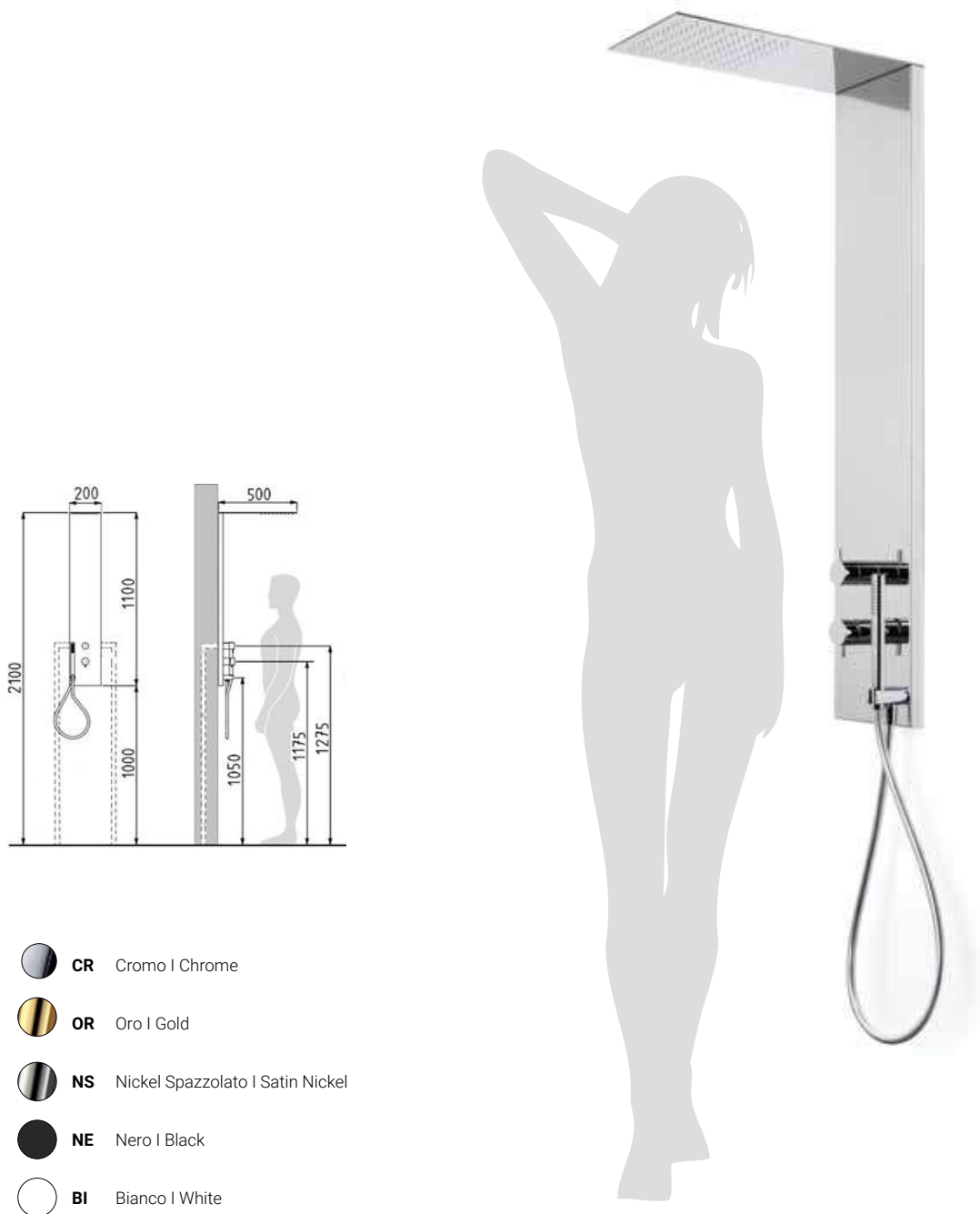

## MIRROR S



-  **CR** Cromo | Chrome
-  **OR** Oro | Gold
-  **NS** Nickel Spazzolato | Satin Nickel
-  **NE** Nero | Black
-  **BI** Bianco | White

<b>S80041ACCM</b>	con monocomando   with shower mixer	<b>1.260,00 €</b>
<b>S80041ACCT</b>	con termostatico   with thermostatic	<b>1.530,00 €</b>





Pannello doccia esterno in acciaio INOX lucido "super mirror", 2 uscite, completo di termostatico.

*External shower panel made with super mirror stainless steel, 2 outputs and thermostatic mixer.*

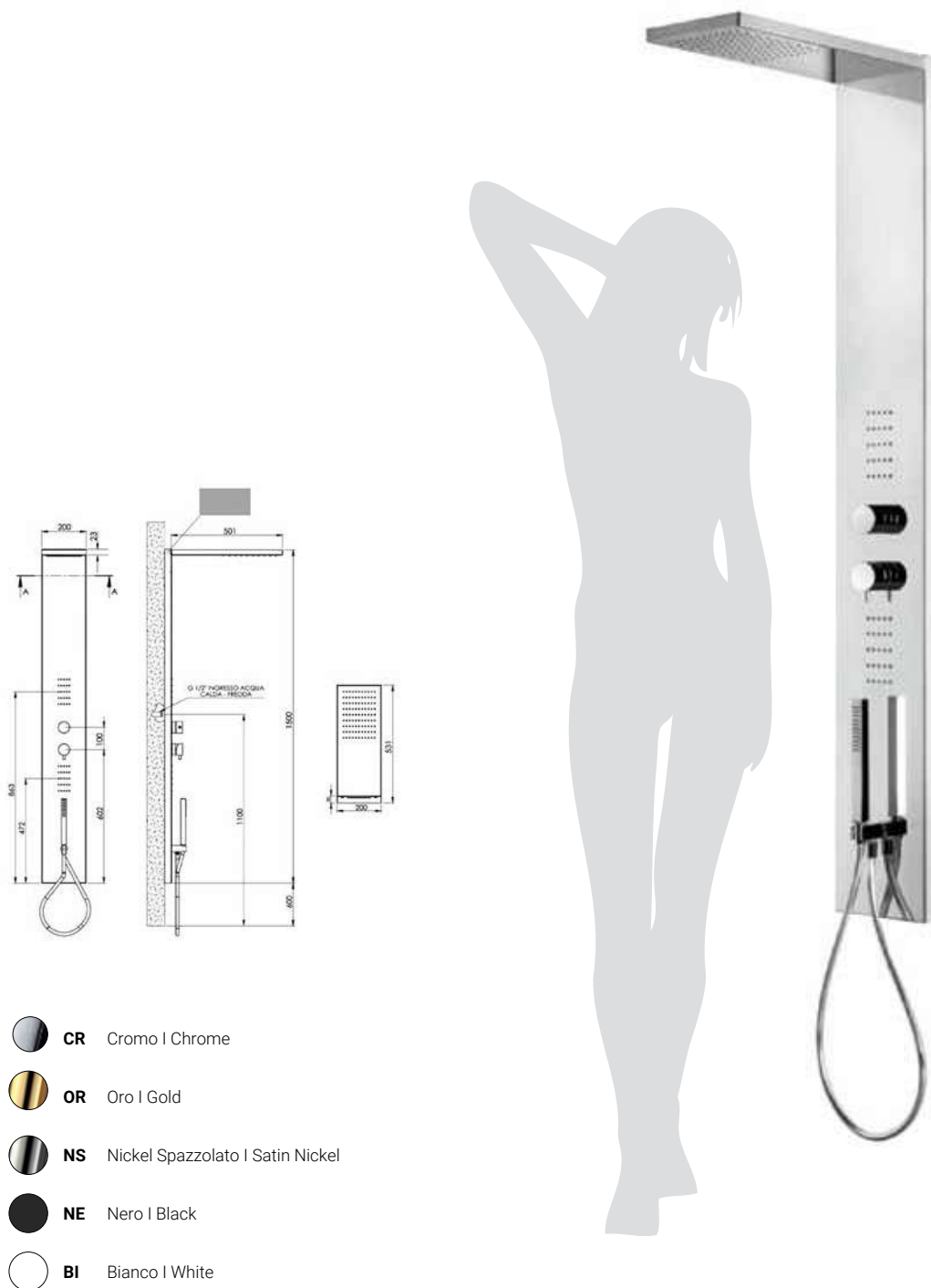

# MIRROR M



-  **CR** Cromo | Chrome
-  **OR** Oro | Gold
-  **NS** Nickel Spazzolato | Satin Nickel
-  **NE** Nero | Black
-  **BI** Bianco | White

<b>M80041ACCM</b>	con monocomando   with shower mixer	<b>1.890,00 €</b>
<b>M80041ACCT</b>	con termostatico   with thermostatic	<b>2.200,00 €</b>





Pannello doccia esterno in acciaio INOX lucido "super mirror", 3 uscite, completo di termostatico.

*External shower panel made with super mirror stainless steel, 3 outputs and thermostatic mixer.*

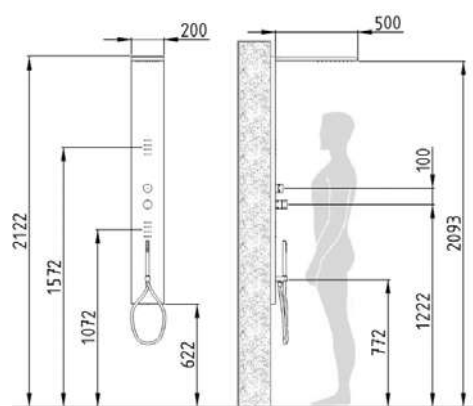

# MIRROR L



-  **CR** Cromo | Chrome
-  **OR** Oro | Gold
-  **NS** Nickel Spazzolato | Satin Nickel
-  **NE** Nero | Black
-  **BI** Bianco | White

<b>L80041ACCM</b>	con monocomando   with shower mixer	<b>2.180,00 €</b>
<b>L80041ACCT</b>	con termostatico   with thermostatic	<b>2.490,00 €</b>

Pannello doccia esterno in acciaio INOX lucido "super mirror", 4 uscite, completo di termostatico.

*External shower panel made with super mirror stainless steel, 4 outputs and thermostatic mixer.*





colonna TOPAZIO con soffione NETTUNO - finitura oro

Le composizioni delle colonne docce sono PERSONALIZZABILI variando soffione e doccetta.

*The customer is free to chose how to PERSONALYZE each shower's colums by changing headshower and shower hand.*

COD.	SEZ.		PAG.
40	○	ANDROMEDA	32
30	□	TOPAZIO	34
32	○	GIADA	38
35	○	GEMMA	42
31	○	AMBRA	46
34	○	PERLA	50
38	□	SMERALDO Q	54
38	○	SMERALDO T	58
36	○	ZAFFIRO T	62
36	□	ZAFFIRO Q	66
37	○	TURCHESE	70
<b>Linea ECO _ ECO line</b>			
76	○	MARE E MONTI	76
77	○	SNELLA T - SNELLA Q	80
C035	○	ICE	86

<p><b>Caratteristiche:</b></p> <ul style="list-style-type: none"> <li>- spessore tubo OTTONE 1,5 mm</li> <li>- scorrevole portadoccia in OTTONE</li> </ul> <p><b>Specifics:</b></p> <ul style="list-style-type: none"> <li>- thickness BRASS tube 1,5 mm</li> <li>- chromed BRASS sliding bar shower holder</li> </ul>
<p><b>Caratteristiche:</b></p> <ul style="list-style-type: none"> <li>- spessore tubo OTTONE 1 mm</li> <li>- scorrevole portadoccia in ABS</li> </ul> <p><b>Specifics:</b></p> <ul style="list-style-type: none"> <li>- thickness BRASS tube 1,5 mm</li> <li>- chromed ABS sliding bar shower holder</li> </ul>

**Accessori colonne doccia**  
Shower columns accessories 90

**Rubinetteria colonne doccia**  
Shower columns taps 92

**Cartucce**  
Cartridges 93

**Come ordinare una colonna doccia**  
How to order a shower column 94

**Esempi combinazioni doccia**  
Example of combinations 96

**Istruzioni di montaggio**  
Installation instructions 98

## FINITURE E MISURE SPECIALI SU RICHIESTA

### SPECIAL FINISHING AND MEASURES ON REQUEST

- |  |  |
|--|--|
|  <b>OR</b> Oro   Gold                 |  <b>NS</b> Nickel Spazzolato   Satin Nickel |
|  <b>VO</b> Vecchio Ottone   Old Brass |  <b>NE</b> Nero   Black                     |
|  <b>VR</b> Vecchio Rame   Old Copper  |  <b>BI</b> Bianco   White                   |



colonna **AMBRA** con soffione **MERCURY** - finitura nero

Sugli articoli in finitura speciale si potrebbero presentare delle imperfezioni, dovute al tipo di lavorazione.  
*Please kindly note that on items in special finishing you may have imperfections due to the type of machining.*





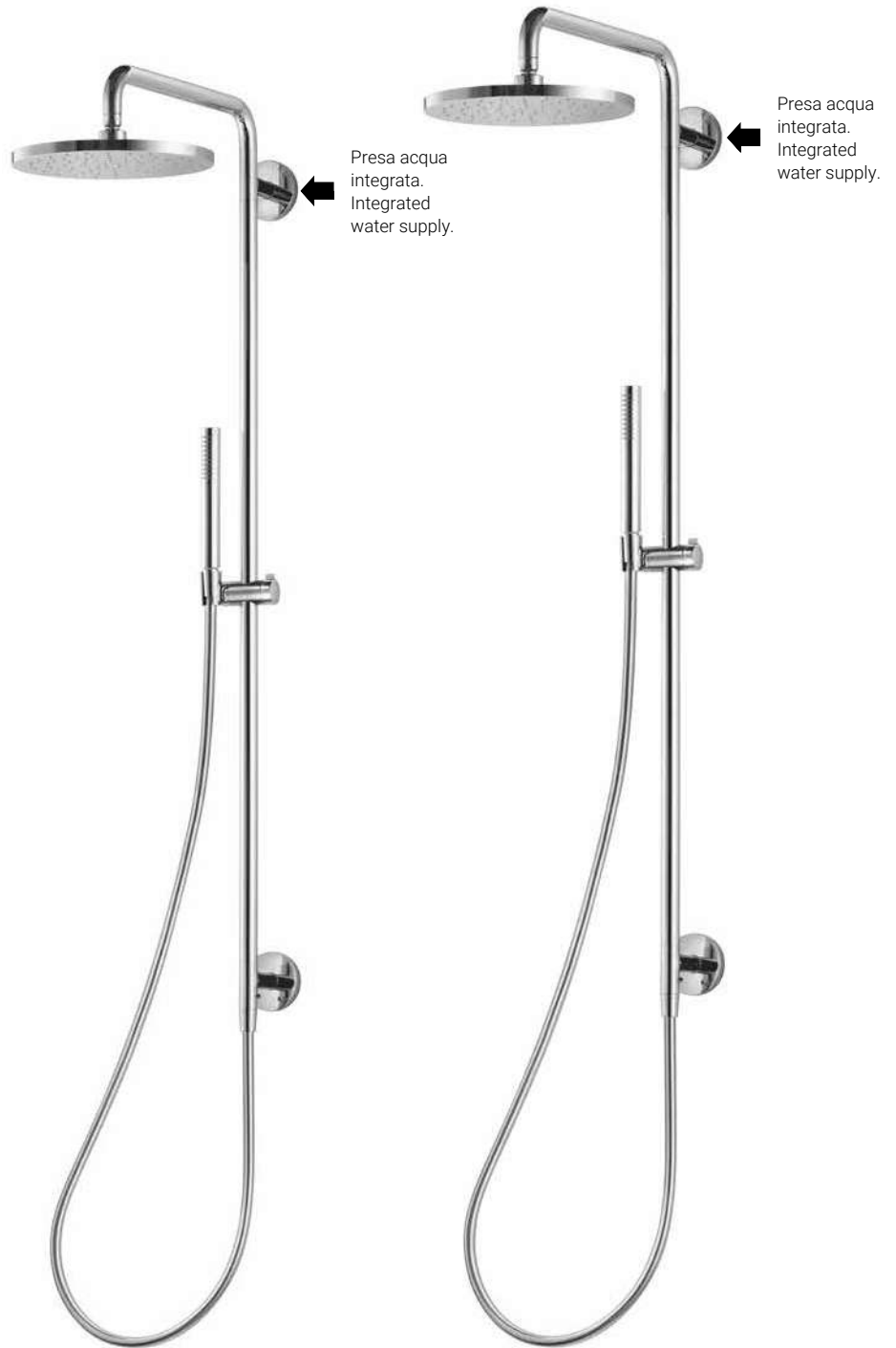

colonna **GIADA** con soffione **MERCURY** - finitura cromo

# ANDROMEDA



Pres a acqua  
integrata.  
Integrated  
water supply.

Pres a acqua  
integrata.  
Integrated  
water supply.

-  **CR** Cromo | Chrome
-  **OR** Oro | Gold
-  **VO** Vecchio Ottone | Old Brass
-  **VR** Vecchio Rame | Old Copper
-  **NS** Nickel Spazzolato | Satin Nickel

**ANDROMEDA 90** con SCIROCCO e doccia ottone

**ANDROMEDA 120** con SCIROCCO e doccia ottone

Colonna doccia in ottone Ø 24mm. Per installazione con gruppo incasso o esterno (non fornito). Completa di deviatore con alimentazione acqua dall'alto. Soffione doccia con snodo. Doccia monogetto anticalcare. Flessibile con attacco conico girevole, lunghezza 150cm.

*Brass shower column diameter 24mm complete with deviator and high water supply. Shower head with swivel ball. Antiscale single-jet handshower. Flexible hose with swivel conical connection. Length 150cm.*



Design ufficio tecnico Aquaviva  
Design by Aquaviva's technical office



# COLONNA COMPLETA \_ COMPLETE SHOWER COLUMN

Finiture speciali su richiesta \_ Special finishing on request

## VALVE INOX TONDO

Ø 25  
ACCIAIO INOX



## SCIROCCO

Ø 20  
ABS



## PENELOPE

Ø 25  
ACCIAIO INOX



Senza rubinetto  
90 cm.

**40070CR90**  
830,00 €

**40080CR90**  
720,00 €

**40090CR90**  
740,00 €

Senza rubinetto  
120 cm.

**40070CR120**  
840,00 €

**40080CR120**  
730,00 €

**40090CR120**  
750,00 €

\* Specificare attacco rubinetto: 1/2" o 3/4".  
Specify connection tap: 1/2" o 3/4".

Specificare interasse rubinetto-muro.  
Specify distance centre tap-wall.

Per una corretta scelta consultare le note tecniche di pag. 94.  
For a correct choice, consult the technical notes on pag. 94.

 Peso del tubo: kg. 2.0  
Weight of the tube: kg. 2.0

## Dettagli tecnici

Dettagli tecnici

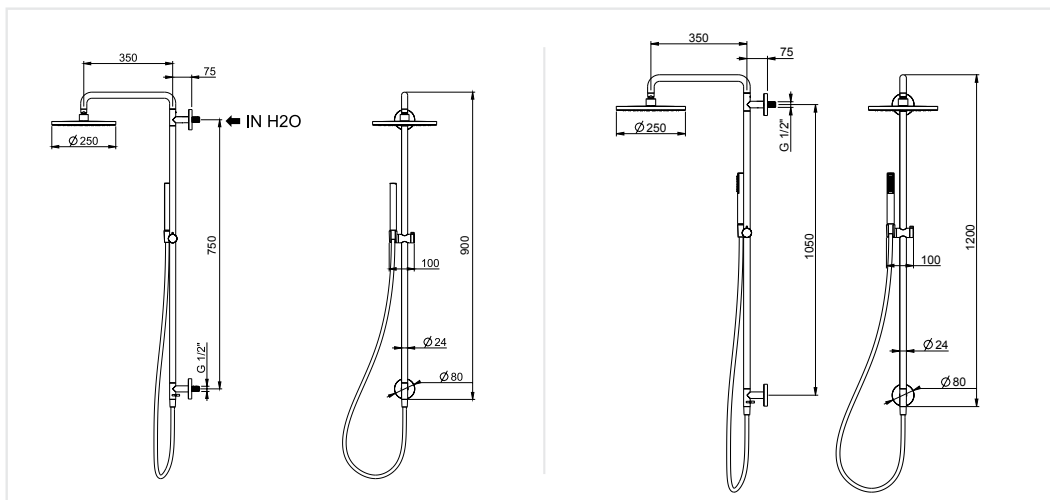





colonna TOPAZIO con soffione PERICLE - finitura oro

# TOPAZIO



 **CR** Cromo | Chrome

 **OR** Oro | Gold

TOPAZIO con NETTUNO

Colonna doccia in ottone  $\square$  24 mm. Soffione doccia con snodo. Doccia monogetto CUBE anticalcare regolabile in altezza. Flessibile doppia aggraffatura con attacco conico girevole, lunghezza 150 cm.

*Brass shower column  $\square$  24 mm. Head shower with swivel ball. Adjustable for height antiscaling single jet shower CUBE. Flexible hose with swivel conical connection, length 150 cm.*



# TOPAZIO

Rubinetteria abbinabile / *Combinable taps*



Termostatico quadro.  
Interasse 150 mm.  
*Square thermostatic mixer.*  
*Interaxis distance 150 mm.*



Monocomando quadro.  
Interasse 150 mm.  
*Square mixer.*  
*Interaxis distance 150 mm*



Termostatico quadro.  
*Square thermostatic mixer..*

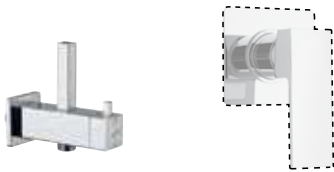

Preso acqua per installazione con monocomando o termostato a incasso già esistente (non fornito).  
*Water supply for installation with concealed shower mixer. Mixer not included.*



Preso acqua quadra special per alimentazione esterna.  
*Special water supply for external water inlet.*

## Dettagli tecnici

*Dettagli tecnici*

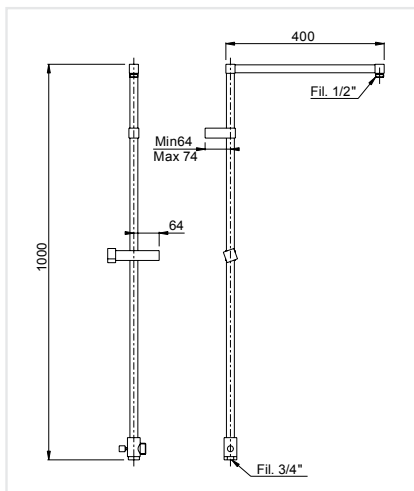

# COLONNA COMPLETA \_ COMPLETE SHOWER COLUMN

Finiture speciali su richiesta \_ Special finishing on request



**NETTUNO**  
20 x 20  
ACCIAIO INOX CROMO



**PERICLE**  
25 x 25  
ACCIAIO INOX



**BORA**  
20 x 20  
ABS



**VALVE INOX  
QUADRO**  
25 x 25  
ACCIAIO INOX



\* Senza rubinetto



**30101CR**  
1.150,00 €

**30103CR**  
1.035,00 €

**30104CR**  
950,00 €

**30107CR**  
940,00 €

Monocomando quadro



**30141CR**  
1.450,00 €

**30143CR**  
1.330,00 €

**30144CR**  
1.244,00 €

**30147CR**  
1.235,00 €

Termostatico quadro



**30121CR**  
1.460,00 €

**30123CR**  
1.335,00 €

**30124CR**  
1.260,00 €

**30127CR**  
1.250,00 €

Preso acqua quadra



**30161CR**  
1.220,00 €

**30163CR**  
1.105,00 €

**30164CR**  
1.020,00 €

**30167CR**  
1.010,00 €

Preso acqua quadra special



**30061CR**  
1.250,00 €

**30063CR**  
1.135,00 €

**30064CR**  
1.050,00 €

**30067CR**  
1.040,00 €

\* Specificare attacco rubinetto: 1/2" o 3/4".  
Specify connection tap: 1/2" o 3/4".

Specificare interasse rubinetto-muro.  
Specify distance centre tap-wall.

Per una corretta scelta consultare le note tecniche di pag. 94.  
For a correct choice, consult the technical notes on pag. 94.

Peso del tubo: kg. 3.8  
Weight of the tube: kg. 3.8







colonna GIADA con soffione PENELOPE - finitura nickel spazzolato

## GIADA



GIADA con DELTA con portasapone crystal

-  **CR** Cromo | Chrome
-  **OR** Oro | Gold
-  **VO** Vecchio Ottone | Old Brass
-  **VR** Vecchio Rame | Old Copper
-  **NS** Nickel Spazzolato | Satin Nickel

Colonna doccia in ottone Ø 18 mm alta 125 cm completa di deviatore. Soffione doccia con snodo. Braccio Ø 21 mm lungh. 35 cm. Doccia monogetto anticalcare regolabile in altezza. Flessibile doppia aggraffatura con attacco conico girevole, lunghezza 150 cm.

*Brass shower column Ø 18 mm height 125 cm complete with diverter. Head shower with swivel ball. Brass shower arm Ø 21 mm length 35 cm. Adjustable for height antiscald single jet shower. Double interlock flexible hose swivel conical connection, length 150 cm.*



# GIADA

Rubinetteria abbinabile / *Combinable taps*



Termostatico da barra.  
Interasse 150 mm.  
*Thermostatic mixer.*  
*interaxis distance 150 mm.*

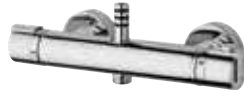

Termostatico MINIMAL.  
Interasse 150 mm.  
*MINIMAL thermostatic mixer.*  
*Interaxis distance 150 mm.*



Gruppo monocomando.  
Interasse 150 mm.  
*Mixer. Interaxis distance 150 mm.*



Preso acqua per installazione con monocomando o termostato a incasso già esistente (non fornito).  
*Water supply for installation with concealed shower mixer.*  
*Mixer not included.*



Preso acqua tonda special per alimentazione esterna.  
*Round special water supply for external water inlet.*

**Portasapone a richiesta**  
*Soap tray on request*



**Dettagli tecnici**  
*Dettagli tecnici*

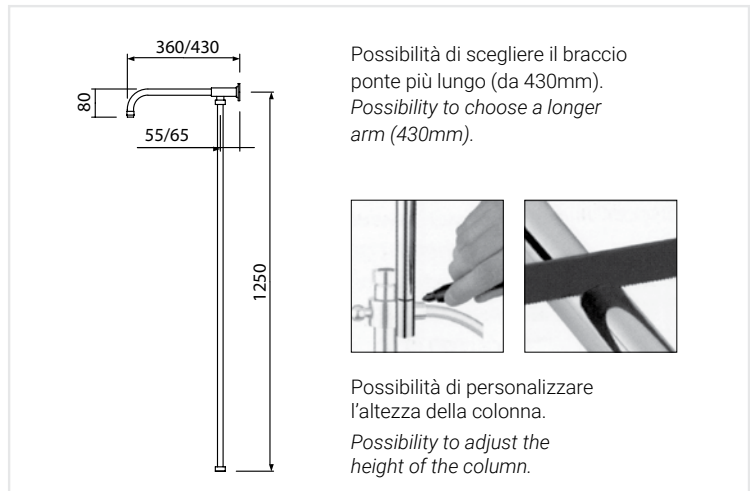

# COLONNA COMPLETA \_ COMPLETE SHOWER COLUMN

Finiture speciali su richiesta \_ Special finishing on request



**DELTA**  
Ø 20  
ACCIAIO INOX CROMO



**SCIROCCO**  
Ø 20  
ABS



**PENELOPE**  
Ø 25  
ACCIAIO INOX



**VALVE INOX TONDO**  
Ø 25  
ACCIAIO INOX



* Senza rubinetto		<b>32105CR</b> 565,00 €	<b>32108CR</b> 450,00 €	<b>32107CR</b> 585,00 €	<b>32109CR</b> 440,00 €
Gruppo monocomando		<b>32155CR</b> 745,00 €	<b>32158CR</b> 631,00 €	<b>32157CR</b> 757,00 €	<b>32159CR</b> 620,00 €
Termostatico da barra		<b>32135CR</b> 811,00 €	<b>32138CR</b> 697,00 €	<b>32137CR</b> 825,00 €	<b>32139CR</b> 690,00 €
Termostatico MINIMAL		<b>32175CR</b> 749,00 €	<b>32178CR</b> 635,00 €	<b>32177CR</b> 750,00 €	<b>32179CR</b> 625,00 €
Presacqua c/ deviatore integrato		<b>32165CR</b> 644,00 €	<b>32168CR</b> 530,00 €	<b>32167CR</b> 665,00 €	<b>32169CR</b> 520,00 €
Presacqua tonda special		<b>32065CR</b> 656,00 €	<b>32068CR</b> 541,00 €	<b>32067CR</b> 670,00 €	<b>32069CR</b> 530,00 €

\* Specificare attacco rubinetto: 1/2" o 3/4".  
Specify connection tap: 1/2" o 3/4".

Specificare interasse rubinetto-muro.  
Specify distance centre tap-wall.

Per una corretta scelta consultare le note tecniche di pag. 94.  
For a correct choice, consult the technical notes on pag. 94.

 Peso del tubo: kg. 3.8  
Weight of the tube: kg. 3.8



colonna GEMMA con soffione PENELOPE - finitura nero

## GEMMA

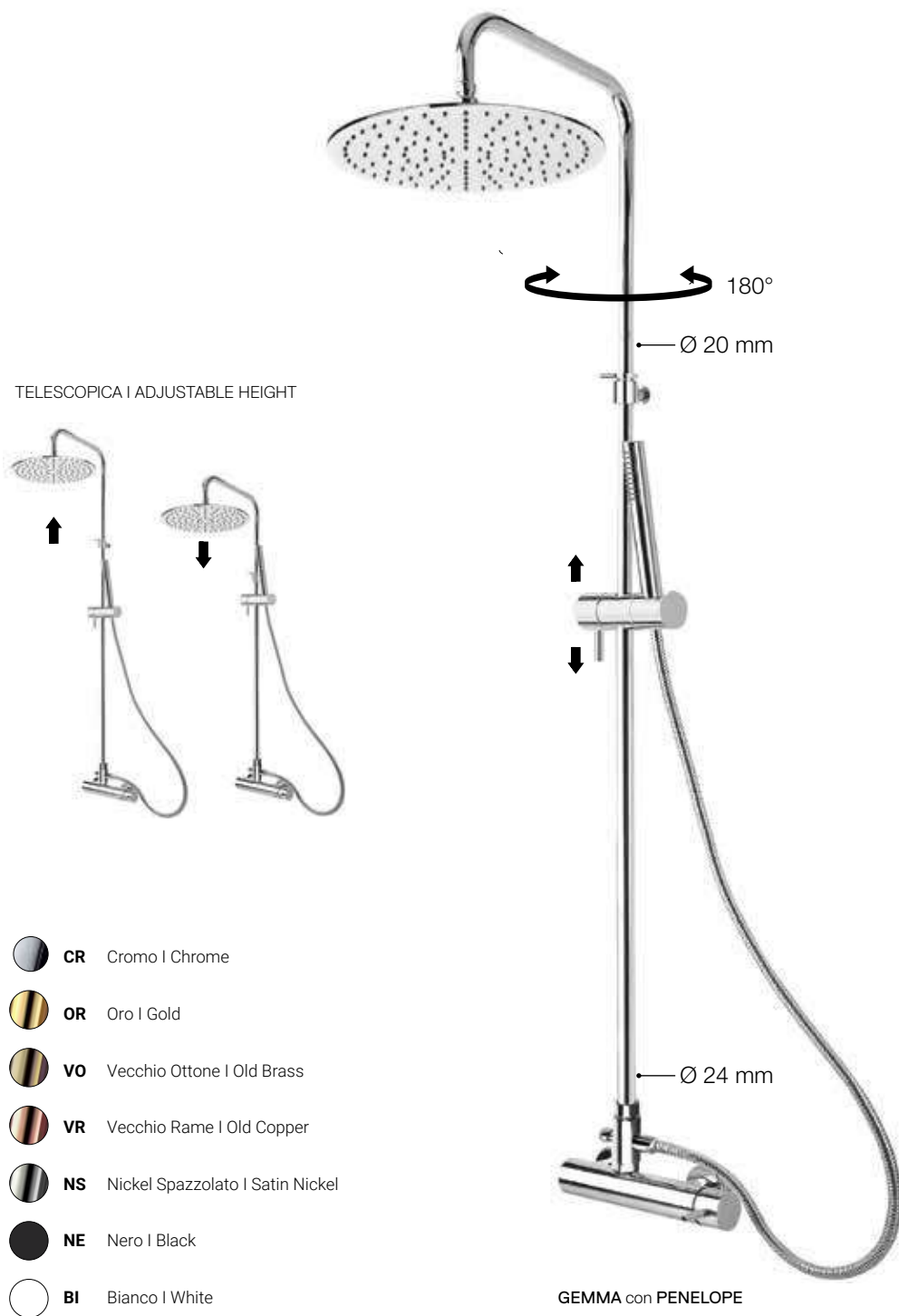

Colonna doccia in ottone Ø 24 mm regolabile in altezza da 68 a 120 cm completa di deviatore. Soffione doccia con snodo. Doccia monogetto anticalcare. Supporto portadoccia scorrevole. Flessibile doppia aggraffatura con attacco conico girevole, lunghezza 150 cm.

*Adjustable brass shower column Ø 24 mm height from 68 to 120 cm complete with diverter. Head shower with swivel ball. Antiscale single jet shower adjustable for height. Double interlock flexible hose swivel conical connection, length 150 cm.*



# GEMMA

Rubinetteria abbinabile / *Combinable taps*



Termostatico da barra.  
Interasse 150 mm.  
*Thermostatic mixer.*  
*interaxis distance 150 mm.*



Termostatico MINIMAL.  
Interasse 150 mm.  
*MINIMAL thermostatic mixer.*  
*Interaxis distance 150 mm.*



Gruppo monocomando.  
Interasse 150 mm.  
*Mixer. Interaxis distance 150 mm.*



Preso acqua per installazione con monocomando o termostato a incasso già esistente (non fornito).  
*Water supply for installation with concealed shower mixer. Mixer not included.*



Preso acqua tonda special per alimentazione esterna.  
*Round special water supply for external water inlet.*

## Dettagli tecnici

*Dettagli tecnici*

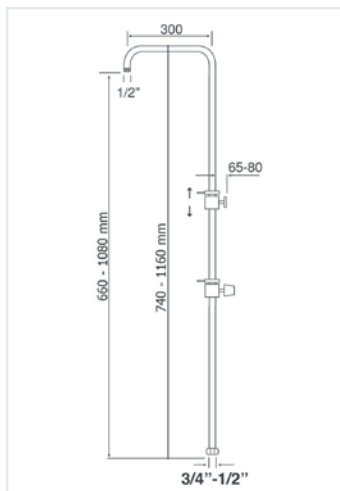

# COLONNA COMPLETA \_ COMPLETE SHOWER COLUMN

Finiture speciali su richiesta \_ Special finishing on request



**PENELOPE**  
Ø 25  
ACCIAIO INOX



**VALVE INOX TONDO**  
Ø 25  
ACCIAIO INOX









**NEW MERCURY**  
ANTICALCARE Ø 20  
OTTONE



**SCIROCCO**  
Ø 20  
ABS



* Senza rubinetto		<b>35107CR</b> 735,00 €	<b>35104CR</b> 655,00 €	<b>35101CR</b> 753,00 €	<b>35105CR</b> 615,00 €
Termostatico da barra		<b>35137CR</b> 980,00 €	<b>35134CR</b> 899,00 €	<b>35131CR</b> 998,00 €	<b>35135CR</b> 860,00 €
Termostatico MINIMAL		<b>35177CR</b> 920,00 €	<b>35174CR</b> 830,00 €	<b>35171CR</b> 930,00 €	<b>35175CR</b> 790,00 €
Gruppo monocomando		<b>35197CR</b> 910,00 €	<b>35194CR</b> 835,00 €	<b>35191CR</b> 935,00 €	<b>35195CR</b> 795,00 €
Presaca c/ deviatore integrato		<b>35167CR</b> 810,00 €	<b>35164CR</b> 730,00 €	<b>35161CR</b> 830,00 €	<b>35165CR</b> 690,00 €
Presaca tonda special		<b>35187CR</b> 825,00 €	<b>35184CR</b> 745,00 €	<b>35181CR</b> 843,00 €	<b>35185CR</b> 705,00 €

\* Specificare attacco rubinetto: 1/2" o 3/4".  
Specify connection tap: 1/2" o 3/4".

Specificare interasse rubinetto-muro.  
Specify distance centre tap-wall.

Per una corretta scelta consultare le note tecniche di pag. 94.  
For a correct choice, consult the technical notes on pag. 94.





 Peso del tubo: kg. 2.3  
Weight of the tube: kg. 2.3



colonna AMBRA con soffione MERCURY - finitura nero

# AMBRA



-  **CR** Cromo | Chrome
-  **OR** Oro | Gold
-  **VO** Vecchio Ottone | Old Brass
-  **VR** Vecchio Rame | Old Copper
-  **NS** Nickel Spazzolato | Satin Nickel

AMBRA con NEW MERCURY

Colonna doccia in ottone Ø 18 mm alta 125 cm completa di deviatore. Soffione doccia con snodo. Braccio Ø 21 mm lunghezza 35 cm. Doccia monogetto regolabile in altezza. Flessibile doppia aggraffatura con attacco conico girevole, lunghezza 150 cm.

*Brass shower column Ø 18 mm height 125 cm complete with diverter. Head shower with swivel ball. Brass shower arm Ø 21 mm length 35 cm. Adjustable for height single jet shower. Double interlock flexible hose with swivel conical connection, length 150 cm.*



# AMBRA

Rubinetteria abbinabile / *Combinable taps*



Gruppo classico.  
Interasse 160 mm.  
*Classic group.*  
*Interaxis distance 160 mm.*



Termostatico da barra.  
Interasse 150 mm.  
*Thermostatic mixer.*  
*interaxis distance 150 mm.*



Termostatico MINIMAL.  
Interasse 150 mm.  
*MINIMAL thermostatic mixer.*  
*Interaxis distance 150 mm.*



Gruppo monocomando.  
Interasse 150 mm.  
*Mixer. Interaxis distance 150 mm.*



Presa acqua per installazione con monocomando o termostato a incasso già esistente (non fornito).  
*Water supply for installation with concealed shower mixer.*  
*Mixer not included.*



Presa acqua tonda special per alimentazione esterna.  
*Round special water supply for external water inlet.*

**Portasapone a richiesta**  
*Soap tray on request*



**Dettagli tecnici**  
*Dettagli tecnici*

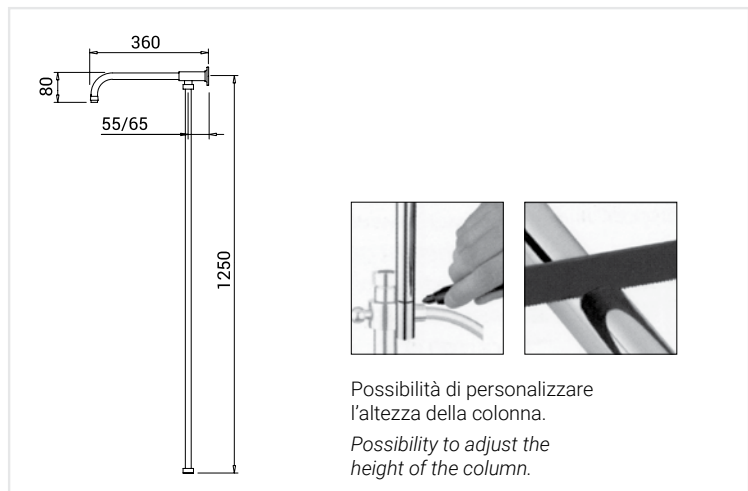

# COLONNA COMPLETA \_ COMPLETE SHOWER COLUMN

Finiture speciali su richiesta \_ Special finishing on request



**NEW MERCURY**  
ANTICALCARE Ø 20  
OTTONE



**PENELOPE**  
Ø 25  
ACCIAIO INOX



**SCIROCCO**  
Ø 20  
ABS



**VALVE INOX TONDO**  
Ø 25  
ACCIAIO INOX



* Senza rubinetto		<b>31101CR</b> 673,00 €	<b>31106CR</b> 665,00 €	<b>31105CR</b> 535,00 €	<b>31107CR</b> 515,00 €
Gruppo classico		<b>31111CR</b> 770,00 €	<b>31116CR</b> 760,00 €	<b>31115CR</b> 630,00 €	<b>31117CR</b> 610,00 €
Gruppo monocomando		<b>31171CR</b> 853,00 €	<b>31176CR</b> 845,00 €	<b>31175CR</b> 715,00 €	<b>31177CR</b> 700,00 €
Termostatico da barra		<b>31131CR</b> 920,00 €	<b>31136CR</b> 910,00 €	<b>31135CR</b> 780,00 €	<b>31137CR</b> 760,00 €
Termostatico MINIMAL		<b>31121CR</b> 858,00 €	<b>31126CR</b> 850,00 €	<b>31125CR</b> 720,00 €	<b>31127CR</b> 700,00 €
Preso acqua c/ deviatore integrato		<b>31161CR</b> 750,00 €	<b>31166CR</b> 740,00 €	<b>31165CR</b> 610,00 €	<b>31167CR</b> 600,00 €
Preso acqua tonda special		<b>31061CR</b> 765,00 €	<b>31066CR</b> 755,00 €	<b>31065CR</b> 625,00 €	<b>31067CR</b> 610,00 €

\* Specificare attacco rubinetto: 1/2" o 3/4".  
Specify connection tap: 1/2" o 3/4".

Specificare interasse rubinetto-muro.  
Specify distance centre tap-wall.

Per una corretta scelta consultare le note tecniche di pag. 94.  
For a correct choice, consult the technical notes on pag. 94.



colonna PERLA con soffione DISCO - finitura cromo

# PERLA







Ø 21 mm

Ø 21 mm

Ø 24 mm

Ø 24 mm

-  **CR** Cromo | Chrome
-  **OR** Oro | Gold
-  **VO** Vecchio Ottone | Old Brass
-  **VR** Vecchio Rame | Old Copper
-  **NS** Nickel Spazzolato | Satin Nickel

PERLA con NEW MERCURY

PERLA con SCIROCCO

Colonna doccia telescopica in ottone Ø 24 mm altezza totale 140 cm completa di deviatore. Soffione doccia con snodo. Doccia monogetto anticalcare regolabile in altezza. Flessibile doppia aggraffatura con attacco conico girevole, lunghezza 150 cm.

Brass telescopic shower column Ø 24 mm. Total height 140 cm complete with diverter. Head shower with swivel ball. Adjustable for height antiscalc single jet shower. Double interlock flexible hose with swivel conical connection, length 150 cm.



# PERLA

Rubinetteria abbinabile / *Combinable taps*



Gruppo classico.  
Interasse 160 mm.  
*Classic group.*  
*Interaxis distance 160 mm.*



Termostatico da barra.  
Interasse 150 mm.  
*Thermostatic mixer.*  
*interaxis distance 150 mm.*



Termostatico MINIMAL.  
Interasse 150 mm.  
*MINIMAL thermostatic mixer.*  
*Interaxis distance 150 mm.*



Gruppo monocomando.  
Interasse 150 mm.  
*Mixer. Interaxis distance 150 mm.*



Preso acqua per installazione con monocomando o termostato a incasso già esistente (non fornito).  
*Water supply for installation with concealed shower mixer.*  
*Mixer not included.*



Preso acqua tonda special per alimentazione esterna.  
*Round special water supply for external water inlet.*

## Dettagli tecnici

*Dettagli tecnici*

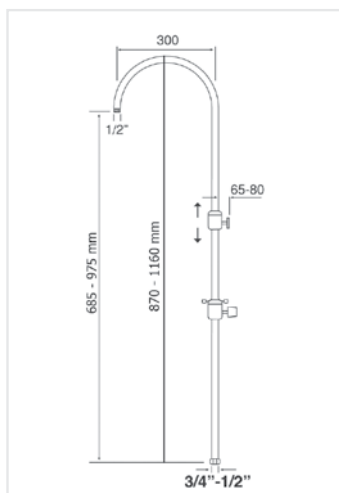

# COLONNA COMPLETA \_ COMPLETE SHOWER COLUMN

Finiture speciali su richiesta \_ Special finishing on request



SCORREVOLE CLASSICO



**NEW MERCURY**  
ANTICALCARE Ø 20  
OTTONE



SCORREVOLE MODERNO



**PENELOPE**  
Ø 25  
ACCIAIO INOX



SCORREVOLE MODERNO



**SCIROCCO**  
Ø 20  
ABS



SCORREVOLE MODERNO



**VALVE INOX TONDO**  
Ø 25  
ACCIAIO INOX



* Senza rubinetto		<b>34105CR</b> 673,00 €	<b>34108CR</b> 665,00 €	<b>34101CR</b> 550,00 €	<b>34102CR</b> 530,00 €
Gruppo classico		<b>34185CR</b> 770,00 €	<b>34188CR</b> 730,00 €	<b>34181CR</b> 650,00 €	<b>34182CR</b> 630,00 €
Gruppo monocomando		<b>34195CR</b> 853,00 €	<b>34198CR</b> 895,00 €	<b>34191CR</b> 970,00 €	<b>34192CR</b> 950,00 €
Termostatico da barra		<b>34135CR</b> 920,00 €	<b>34138CR</b> 960,00 €	<b>34131CR</b> 800,00 €	<b>34132CR</b> 780,00 €
Termostatico MINIMAL		<b>34175CR</b> 858,00 €	<b>34178CR</b> 900,00 €	<b>34171CR</b> 740,00 €	<b>34172CR</b> 720,00 €
Preso acqua c/ deviatore integrato		<b>34165CR</b> 750,00 €	<b>34168CR</b> 790,00 €	<b>34161CR</b> 630,00 €	<b>34162CR</b> 615,00 €
Preso acqua tonda special		<b>34085CR</b> 765,00 €	<b>34088CR</b> 805,00 €	<b>34081CR</b> 655,00 €	<b>34082CR</b> 635,00 €

\* Specificare attacco rubinetto: 1/2" o 3/4".  
Specify connection tap: 1/2" o 3/4".

Specificare interasse rubinetto-muro.  
Specify distance centre tap-wall.





Per una corretta scelta consultare le note tecniche di pag. 94.  
For a correct choice, consult the technical notes on pag. 94.



colonna **SMERALDO Q** con soffione **NETTUNO** - finitura cromo

## SMERALDO Q



-  **CR** Cromo | Chrome
-  **OR** Oro | Gold
-  **VO** Vecchio Ottone | Old Brass
-  **VR** Vecchio Rame | Old Copper
-  **NS** Nickel Spazzolato | Satin Nickel

SMERALDO Q con NETTUNO

Colonna doccia in ottone Ø 24 mm regolabile in altezza da 68 a 120 cm completa di deviatore. Soffione doccia con snodo. Doccia monogetto anticalcare. Supporto portadoccia scorrevole. Flessibile doppia aggraffatura con attacco conico girevole, lunghezza 150 cm.

*Adjustable brass shower column Ø 24 mm height from 68 to 120 cm complete with diverter. Head shower with swivel ball. Antiscale single jet shower adjustable for height. Double interlock flexible hose swivel conical connection, length 150 cm.*



# SMERALDO Q

Rubinetteria abbinabile / *Combinable taps*



Monocomando quadro.  
Interasse 150 mm.  
*Square mixer.*  
*Interaxis distance 150 mm*



Termostatico quadro.  
*Square thermostatic mixer.*



Termostatico da barra quadro.  
Interasse 150 mm.  
*Square thermostatic mixer.*  
*Interaxis distance 150 mm.*

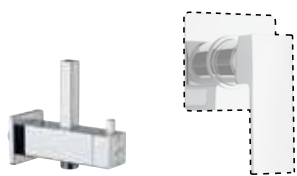

Preso acqua per installazione con monocomando o termostato a incasso già esistente (non fornito).  
*Water supply for installation with concealed shower mixer. Mixer not included.*



Preso acqua quadra special per alimentazione esterna.  
*Special water supply for external water inlet.*

## Dettagli tecnici

*Dettagli tecnici*

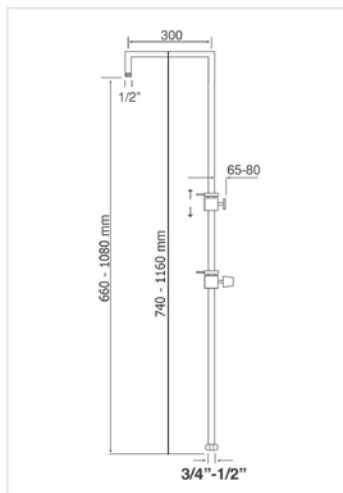

## COLONNA COMPLETA \_ COMPLETE SHOWER COLUMN

Finiture speciali su richiesta \_ Special finishing on request



**NETTUNO**  
20 x 20  
ACCIAIO INOX



**LYRAE**  
24 x 36  
ABS



**PERICLE**  
25 x 25  
ACCIAIO INOX



**VALVE INOX  
QUADRO**  
25 x 25  
ACCIAIO INOX



\* Senza  
rubinetto



**38105CR**  
831,00 €

**38107CR**  
764,00 €

**38106CR**  
801,00 €

**38108CR**  
660,00 €

Termostatico  
da barra quadro



**38195CR**  
1.161,00 €

**38197CR**  
1.094,00 €

**38196CR**  
1.131,00 €

**38198CR**  
995,00 €

Monocomando  
quadro



**38145CR**  
1.125,00 €

**38147CR**  
1.060,00 €

**38146CR**  
1.095,00 €

**38148CR**  
960,00 €

Preso acqua  
c/ deviatore  
integrato



**38185CR**  
901,00 €

**38187CR**  
835,00 €

**38186CR**  
870,00 €

**38188CR**  
740,00 €

Preso acqua  
tonda special



**38085CR**  
930,00 €

**38087CR**  
865,00 €

**38086CR**  
900,00 €

**38088CR**  
770,00 €

\* Specificare attacco rubinetto: 1/2" o 3/4".  
Specify connection tap: 1/2" o 3/4".

Specificare interasse rubinetto-muro.  
Specify distance centre tap-wall.

Per una corretta scelta consultare le note tecniche di pag. 94.  
For a correct choice, consult the technical notes on pag. 94.





 Peso del tubo: kg. 2.0  
Weight of the tube: kg. 2.0

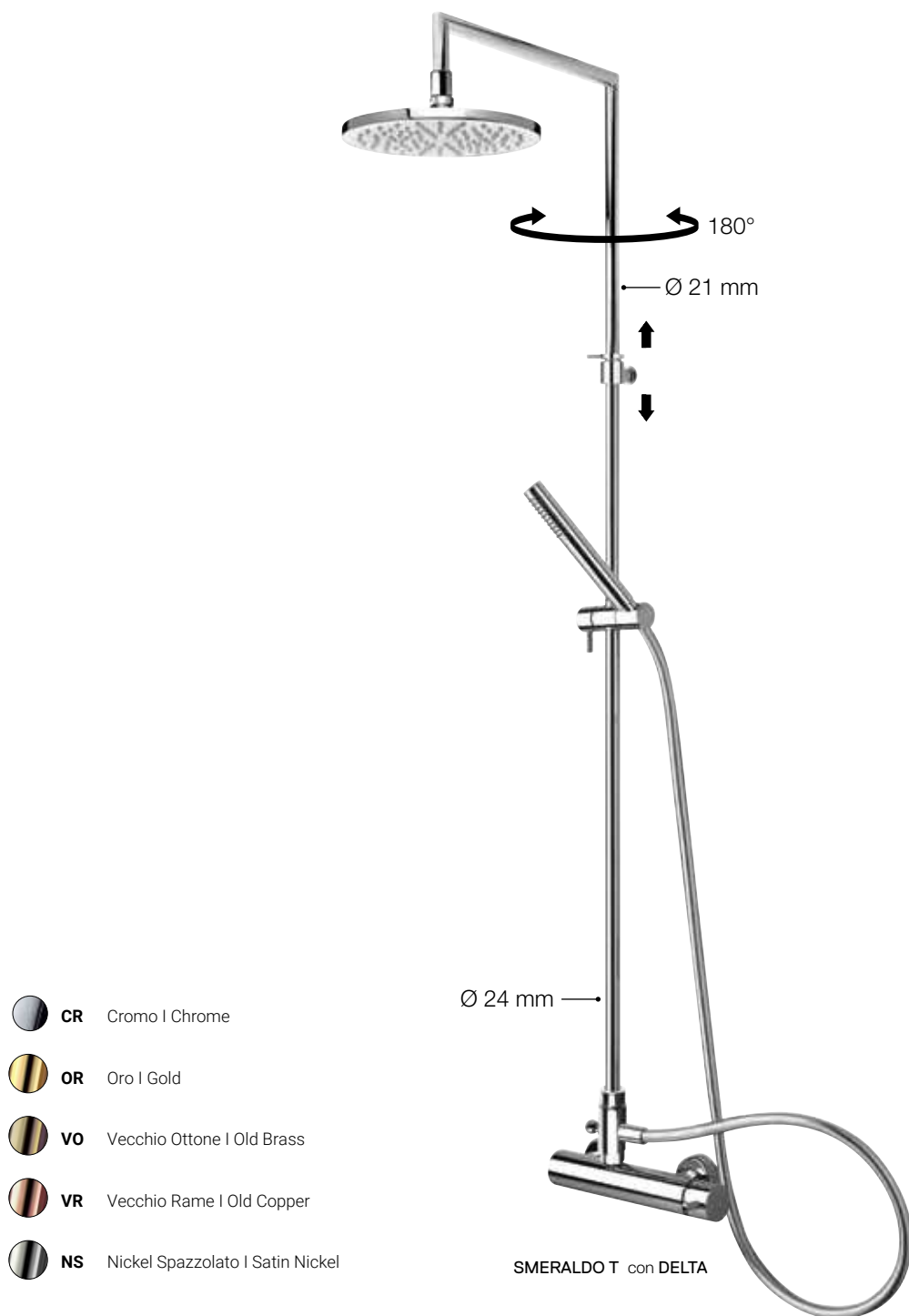

colonna SMERALDO T con soffione DELTA - finitura cromo

## SMERALDO T



-  **CR** Cromo | Chrome
-  **OR** Oro | Gold
-  **VO** Vecchio Ottone | Old Brass
-  **VR** Vecchio Rame | Old Copper
-  **NS** Nickel Spazzolato | Satin Nickel

SMERALDO T con DELTA

Colonna doccia in ottone Ø 24 mm regolabile in altezza da 68 a 120 cm completa di deviatore. Soffione doccia con snodo. Doccia monogetto anticalcare. Supporto portadoccia scorrevole. Flessibile doppia aggraffatura con attacco conico girevole, lunghezza 150 cm.

*Adjustable brass shower column Ø 24 mm height from 68 to 120 cm complete with diverter. Head shower with swivel ball. Antiscale single jet shower adjustable for height. Double interlock flexible hose swivel conical connection, length 150 cm.*



# SMERALDO T

Rubinetteria abbinabile / *Combinable taps*



Termostatico da barra.  
Interasse 150 mm.  
*Thermostatic mixer.*  
*interaxis distance 150 mm.*



Termostatico MINIMAL.  
Interasse 150 mm.  
*MINIMAL thermostatic mixer.*  
*Interaxis distance 150 mm.*



Gruppo monocomando.  
Interasse 150 mm.  
*Mixer. Interaxis distance 150 mm.*



Preso acqua per installazione con monocomando o  
termostato a incasso già esistente (non fornito).  
*Water supply for installation with concealed shower mixer.*  
*Mixer not included.*



Preso acqua tonda special  
per alimentazione esterna.  
*Round special water supply*  
*for external water inlet.*

## Dettagli tecnici

*Dettagli tecnici*

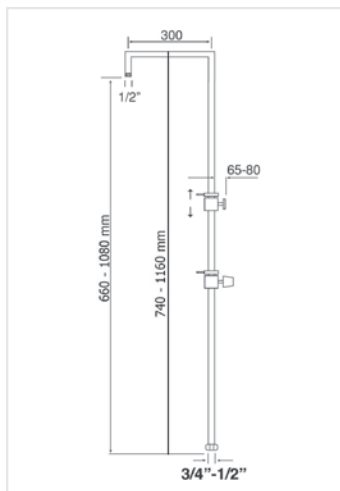

# COLONNA COMPLETA \_ COMPLETE SHOWER COLUMN

Finiture speciali su richiesta \_ Special finishing on request



**DELTA**  
Ø 20  
ACCIAIO INOX



**SCIROCCO**  
Ø 20  
ABS



**PENELOPE**  
Ø 25  
ACCIAIO INOX



**VALVE INOX TONDO**  
Ø 25  
ACCIAIO INOX



\* Senza rubinetto



**38101CR**  
675,00 €

**38109CR**  
560,00 €

**38104CR**  
675,00 €

**38102CR**  
675,00 €

Termostatico da barra



**38131CR**  
920,00 €

**38139CR**  
810,00 €

**38134CR**  
925,00 €

**38132CR**  
925,00 €

Termostatico MINIMAL



**38171CR**  
855,00 €

**38179CR**  
740,00 €

**38174CR**  
855,00 €

**38172CR**  
855,00 €

Gruppo monocomando



**38121CR**  
855,00 €

**38129CR**  
740,00 €

**38124CR**  
855,00 €

**38122CR**  
855,00 €

Preso acqua c/ deviatore integrato



**38161CR**  
750,00 €

**38169CR**  
635,00 €

**38164CR**  
750,00 €

**38162CR**  
750,00 €

Preso acqua tonda special



**38061CR**  
765,00 €

**38069CR**  
650,00 €

**38064CR**  
765,00 €

**38062CR**  
765,00 €

\* Specificare attacco rubinetto: 1/2" o 3/4".  
Specify connection tap: 1/2" o 3/4".

Specificare interasse rubinetto-muro.  
Specify distance centre tap-wall.

Per una corretta scelta consultare le note tecniche di pag. 94.  
For a correct choice, consult the technical notes on pag. 94.





Peso del tubo: kg. 2.0  
Weight of the tube: kg. 2.0



colonna ZAFFIRO con soffione DELTA - finitura cromo

## ZAFFIRO T



-  **CR** Cromo | Chrome
-  **OR** Oro | Gold
-  **VO** Vecchio Ottone | Old Brass
-  **VR** Vecchio Rame | Old Copper
-  **NS** Nickel Spazzolato | Satin Nickel

ZAFFIRO T con DELTA e doccia ottone

Colonna doccia telescopica in ottone Ø 24 mm. Altezza totale 125 cm completa di deviatore. Soffione doccia con snodo. Doccia monogetto anticalcare regolabile in altezza. Flessibile doppia aggraffatura con attacco conico girevole, lunghezza 150 cm.

*Brass telescopic shower column Ø 24 mm. Total height 125 cm complete with diverter. Head shower with swivel ball. Adjustable for height antiscalc single jet shower. Double interlock flexible hose with swivel conical connection, length 150 cm.*



# ZAFFIRO T

Rubinetteria abbinabile / *Combinable taps*



Termostatico da barra.  
Interasse 150 mm.  
*Thermostatic mixer.  
interaxis distance 150 mm.*



Termostatico MINIMAL.  
Interasse 150 mm.  
*MINIMAL thermostatic mixer.  
Interaxis distance 150 mm.*



Gruppo monocomando.  
Interasse 150 mm.  
*Mixer. Interaxis distance 150 mm.*



Preso acqua per installazione con monocomando o  
termostato a incasso già esistente (non fornito).  
*Water supply for installation with concealed shower mixer.  
Mixer not included.*



Preso acqua tonda special  
per alimentazione esterna.  
*Round special water supply  
for external water inlet.*

## Dettagli tecnici

*Dettagli tecnici*

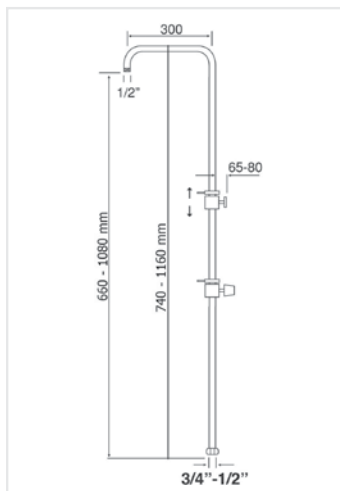

## COLONNA COMPLETA \_ COMPLETE SHOWER COLUMN

Finiture speciali su richiesta \_ Special finishing on request



**VALVE INOX  
TONDO**  
Ø 25  
ACCIAIO INOX



**SCIROCCO**  
Ø 20  
ABS



**PENELOPE**  
Ø 25  
ACCIAIO INOX



\* Senza  
rubinetto



**36100CR**  
535,00 €

**36107CR**  
549,00 €

**36103CR**  
635,00 €

Termostatico  
da barra



**36130CR**  
785,00 €

**36137CR**  
799,00 €

**36133CR**  
885,00 €

Termostatico  
MINIMAL



**36170CR**  
725,00 €

**36177CR**  
737,00 €

**36173CR**  
825,00 €

Gruppo  
monocomando  
moderno



**36180CR**  
722,00 €

**36187CR**  
736,00 €

**36183CR**  
820,00 €

Preso acqua  
c/ deviatore  
integrato



**36160CR**  
615,00 €

**36167CR**  
630,00 €

**36163CR**  
720,00 €

Preso acqua  
tonda special



**36060CR**  
640,00 €

**36067CR**  
650,00 €

**36063CR**  
740,00 €

\* Specificare attacco rubinetto: 1/2" o 3/4".  
Specify connection tap: 1/2" o 3/4".

Specificare interasse rubinetto-muro.  
Specify distance centre tap-wall.

Per una corretta scelta consultare le note tecniche di pag. 94.  
For a correct choice, consult the technical notes on pag. 94.





 Peso del tubo: kg. 2.0  
Weight of the tube: kg. 2.0



colonna ZAFFIRO Q - finitura cromo

## ZAFFIRO Q



-  **CR** Cromo | Chrome
-  **OR** Oro | Gold
-  **VO** Vecchio Ottone | Old Brass
-  **VR** Vecchio Rame | Old Copper
-  **NS** Nickel Spazzolato | Satin Nickel

ZAFFIRO Q con PERICLE e doccia ottone

Colonna doccia telescopica in ottone Ø 24 mm. Altezza totale 125 cm completa di deviatore. Soffione doccia con snodo. Doccia monogetto anticalcare regolabile in altezza. Flessibile doppia aggraffatura con attacco conico girevole, lunghezza 150 cm.

*Brass telescopic shower column Ø 24 mm. Total height 125 cm complete with diverter. Head shower with swivel ball. Adjustable for height antiscalc single jet shower. Double interlock flexible hose with swivel conical connection, length 150 cm.*



# ZAFFIRO Q

Rubinetteria abbinabile / *Combinable taps*



Monocomando quadro.  
Interasse 150 mm.  
*Square mixer.*  
*Interaxis distance 150 mm*



Termostatico da barra quadro.  
Interasse 150 mm.  
*Square thermostatic mixer.*  
*Interaxis distance 150 mm.*

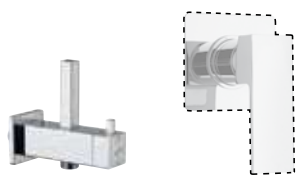

Preso acqua per installazione con monocomando o termostato a incasso già esistente (non fornito).  
*Water supply for installation with concealed shower mixer.*  
*Mixer not included.*



Preso acqua quadra special per alimentazione esterna.  
*Special water supply for external water inlet.*

## Dettagli tecnici

*Dettagli tecnici*

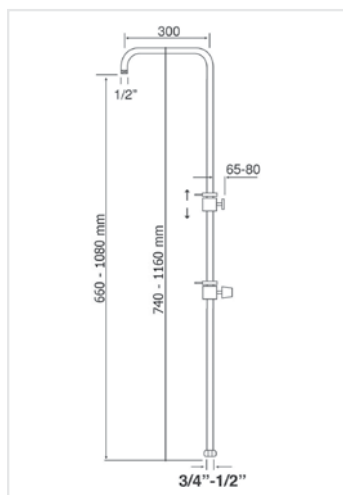

## COLONNA COMPLETA \_ COMPLETE SHOWER COLUMN

Finiture speciali su richiesta \_ Special finishing on request



**BORA**  
20 x 20  
ABS



**PERICLE**  
25 x 25  
ACCIAIO INOX



**VALVE INOX  
QUADRO**  
25 x 25  
ACCIAIO INOX



* Senza rubinetto		<b>36108CR</b> 630,00 €	<b>36109CR</b> 760,00 €	<b>36106CR</b> 620,00 €
Termostatico da barra quadro		<b>36138CR</b> 835,00 €	<b>36139CR</b> 960,00 €	<b>36136CR</b> 850,00 €
Monocomando quadro		<b>36188CR</b> 840,00 €	<b>36189CR</b> 970,00 €	<b>36186CR</b> 830,00 €
Presacqua c/ deviatore integrato		<b>36168CR</b> 650,00 €	<b>36169CR</b> 780,00 €	<b>36166CR</b> 640,00 €
Presacqua tonda special		<b>36068CR</b> 660,00 €	<b>36069CR</b> 790,00 €	<b>36066CR</b> 650,00 €

\* Specificare attacco rubinetto: 1/2" o 3/4".  
Specify connection tap: 1/2" o 3/4".

Specificare interasse rubinetto-muro.  
Specify distance centre tap-wall.

Per una corretta scelta consultare le note tecniche di pag. 94.  
For a correct choice, consult the technical notes on pag. 94.





 Peso del tubo: kg. 2.0  
Weight of the tube: kg. 2.0

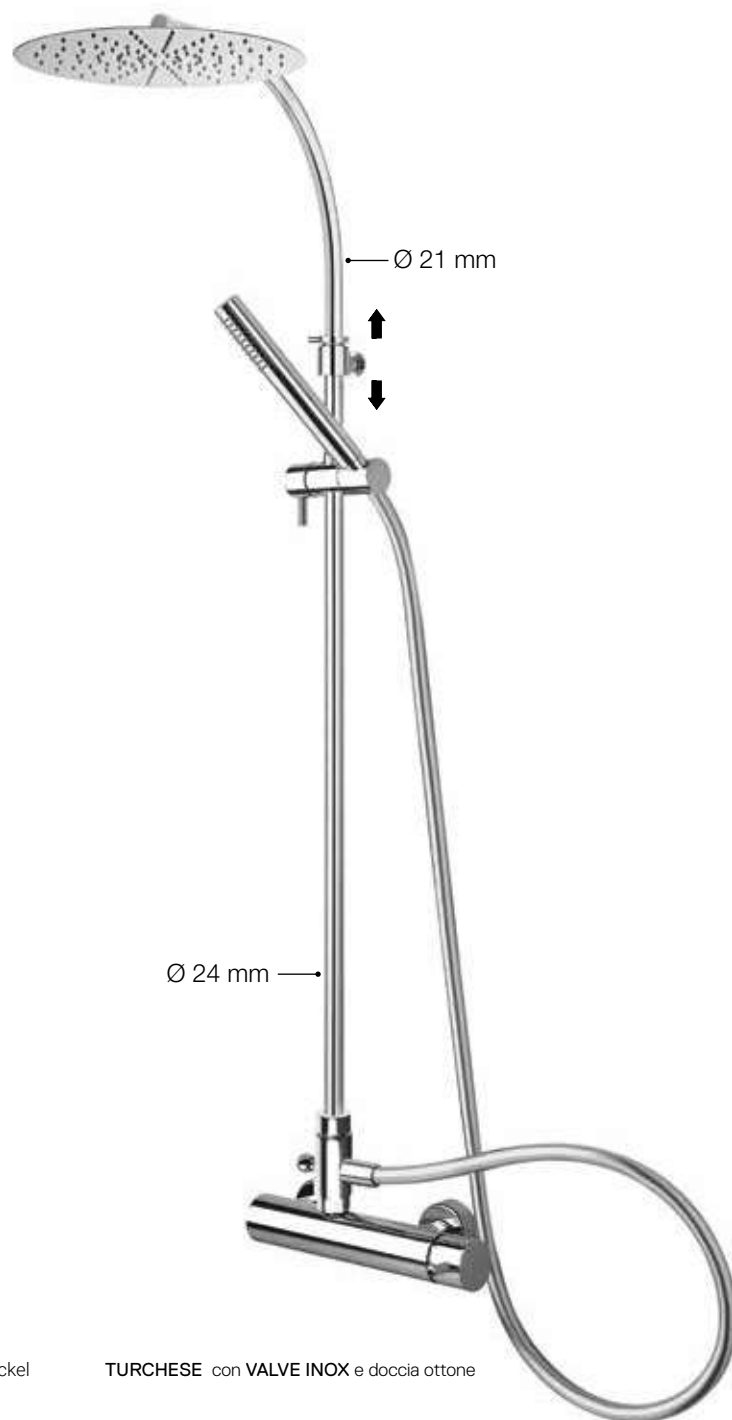

colonna **TURCHESE** - finitura cromo

# TURCHESE



-  **CR** Cromo | Chrome
-  **OR** Oro | Gold
-  **VO** Vecchio Ottone | Old Brass
-  **VR** Vecchio Rame | Old Copper
-  **NS** Nickel Spazzolato | Satin Nickel

**TURCHESE** con VALVE INOX e doccia ottone

Colonna doccia in ottone Ø 24 mm. Altezza totale 125 cm completa di deviatore. Soffione doccia con snodo. Doccia monogetto anticalcare regolabile in altezza. Flessibile doppia aggraffatura con attacco conico girevole, lunghezza 150 cm.

*Brass shower column Ø 24 mm. Total height 125 cm complete with diverter. Head shower with swivel ball. Adjustable for height antiscald single jet shower. Double interlock flexible hose with swivel conical connection, length 150 cm.*



# TURCHESE

Rubinetteria abbinabile / *Combinable taps*



Termostatico MINIMAL.  
Interasse 150 mm.  
*MINIMAL thermostatic mixer.*  
*Interaxis distance 150 mm.*



Gruppo monocomando.  
Interasse 150 mm.  
*Mixer. Interaxis distance 150 mm.*



Presca acqua per installazione con monocomando o termostato a incasso già esistente (non fornito).  
*Water supply for installation with concealed shower mixer.*  
*Mixer not included.*



Presca acqua tonda special per alimentazione esterna.  
*Round special water supply for external water inlet.*

## Dettagli tecnici

*Dettagli tecnici*

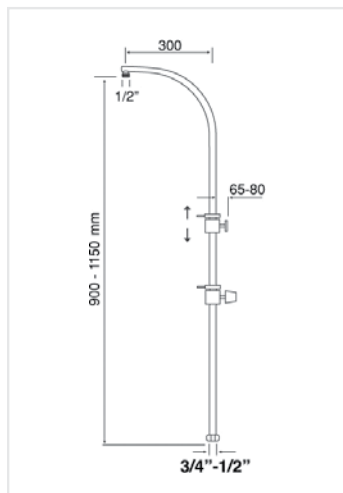

## COLONNA COMPLETA \_ COMPLETE SHOWER COLUMN

Finiture speciali su richiesta \_ Special finishing on request



**VALVE INOX  
TONDO**  
Ø 25  
ACCIAIO INOX



**SCIROCCO**  
Ø 20  
ABS



**PENELOPE**  
Ø 25  
ACCIAIO INOX



\* Senza  
rubinetto



**37109CR**  
530,00 €

**37108CR**  
540,00 €

**37107CR**  
630,00 €

Termostatico  
MINIMAL



**37179CR**  
720,00 €

**37178CR**  
725,00 €

**37177CR**  
820,00 €

Gruppo  
monocomando  
moderno



**37159CR**  
715,00 €

**37158CR**  
730,00 €

**37157CR**  
810,00 €

Preso acqua  
c/ deviatore  
integrato



**37169CR**  
620,00 €

**37168CR**  
610,00 €

**37167CR**  
710,00 €

Preso acqua  
tonda special



**37069CR**  
640,00 €

**37068CR**  
635,00 €

**37067CR**  
730,00 €

\* Specificare attacco rubinetto: 1/2" o 3/4".  
Specify connection tap: 1/2" o 3/4".

Specificare interasse rubinetto-muro.  
Specify distance centre tap-wall.

Per una corretta scelta consultare le note tecniche di pag. 94.  
For a correct choice, consult the technical notes on pag. 94.

 Peso del tubo: kg. 2.0  
Weight of the tube: kg. 2.0

# LINEA ECO

ECO LINE



MARE E MONTI con SCIROCCO



ICE con ULTRAPIATTO



SNELLA con ULTRAPIATTO



ICE con ULTRAPIATTO



colonna MARE E MONTI con soffione SCIROCCO - finitura cromo

# MARE E MONTI



**76131CR**  
MARE E MONTI con SCIROCCO



**76136CR**  
MARE E MONTI con ULTRAPIATTO



**76132CR**  
MARE E MONTI con BORA

 **CR** Cromo I Chrome

Tubazione spessore 1 mm.  
Scorrevole portadoccia in ABS cromato.

*Thickness tube 1 mm.  
ABS sliding bar shower holder.*



Design ufficio tecnico Aquaviva  
Design by Aquaviva's technical office



# MARE E MONTI

## Dettagli tecnici

Dettagli tecnici

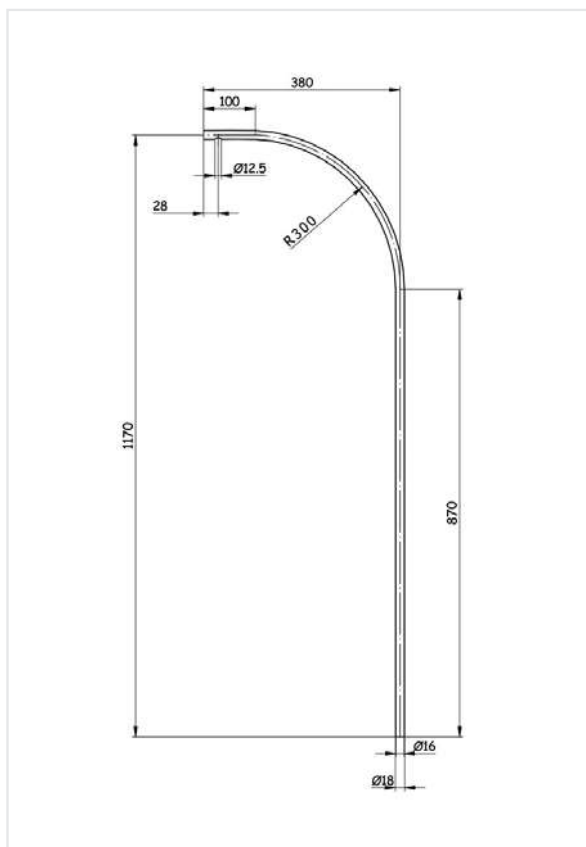

## Portasapone a richiesta

Soap tray on request



Possibilità di tagliare la tubazione.

*Possibility to adjust the eight of the column.*

## COLONNA COMPLETA \_ COMPLETE SHOWER COLUMN

Finiture speciali su richiesta \_ Special finishing on request

COMBINAZIONI POSSIBILI  
POSSIBLE COMBINATIONS**76131CR**

Colonna Mari e Monti con tubazione in OTTONE Ø18, termostatico, soffione SCIROCCO Ø200 in ABS cromato e ispezionabile, doccetta monogetto.

540,00 €

**76195CR**

Colonna Mari e Monti con tubazione in OTTONE Ø18, monocomando, soffione SCIROCCO Ø200 in ABS cromato e ispezionabile, doccetta monogetto.

530,00 €

**76161CR**

Colonna Mari e Monti con tubazione in OTTONE Ø18, presa acqua per installazione con incasso (non fornito), soffione SCIROCCO Ø200 in ABS cromato e ispezionabile, doccetta monogetto.

440,00 €

**76181CR**

Colonna Mari e Monti con tubazione in OTTONE Ø18, presa acqua special per installazione su rubinetto con alimentazione esterna e doppio flessibile, soffione SCIROCCO Ø200 in ABS cromato e ispezionabile, doccetta monogetto.

470,00 €

**76136CRV**

Colonna Mari e Monti con tubazione in OTTONE Ø18, termostatico, soffione ACCIAIO con valvola di sicurezza di sicurezza, doccetta monogetto.

Ø200 555,00 €  
Ø250 571,00 €  
Ø300 587,00 €

**76196CRV**

Colonna Mari e Monti con tubazione in OTTONE Ø18, monocomando, soffione ACCIAIO con valvola di sicurezza, doccetta monogetto.

Ø200 553,00 €  
Ø250 569,00 €  
Ø300 585,00 €

**76166CRV**

Colonna Mari e Monti con tubazione in OTTONE Ø18, presa acqua per installazione con incasso (non fornito), soffione ACCIAIO con valvola di sicurezza, doccetta monogetto.

Ø200 455,00 €  
Ø250 465,00 €  
Ø300 481,00 €

**76186CRV**

Colonna Mari e Monti con tubazione in OTTONE Ø18, presa acqua special per installazione su rubinetto con alimentazione esterna e doppio flessibile, soffione ACCIAIO con valvola di sicurezza, doccetta monogetto.

Ø200 490,00 €  
Ø250 500,00 €  
Ø300 515,00 €



con valvola di sicurezza

**76136CRE**

Colonna Mari e Monti con tubazione in OTTONE Ø18, termostatico, soffione ACCIAIO non ispezionabile, doccetta monogetto.

Ø200 520,00 €  
Ø250 540,00 €  
Ø300 557,00 €

**76196CRE**

Colonna Mari e Monti con tubazione in OTTONE Ø18, monocomando, soffione ACCIAIO non ispezionabile, doccetta monogetto.

Ø200 510,00 €  
Ø250 530,00 €  
Ø300 555,00 €

**76166CRE**

Colonna Mari e Monti con tubazione in OTTONE Ø18, presa acqua per installazione con incasso (non fornito), soffione ACCIAIO non ispezionabile, doccetta monogetto.

Ø200 430,00 €  
Ø250 440,00 €  
Ø300 451,00 €

**76186CRE**

Colonna Mari e Monti con tubazione in OTTONE Ø18, presa acqua special per installazione su rubinetto con alimentazione esterna e doppio flessibile, soffione ACCIAIO non ispezionabile, doccetta monogetto.

Ø200 460,00 €  
Ø250 470,00 €  
Ø300 480,00 €

**76132CR**

Colonna Mari e Monti con tubazione in OTTONE Ø18, termostatico, soffione BORA 200x200 in ABS cromato e ispezionabile, doccetta monogetto.

555,00 €

**76192CR**

Colonna Mari e Monti con tubazione in OTTONE Ø18, monocomando, soffione BORA 200x200 in ABS cromato e ispezionabile, doccetta monogetto.

545,00 €

**76162CR**

Colonna Mari e Monti con tubazione in OTTONE Ø18, presa acqua per installazione con incasso (non fornito), soffione BORA 200x200 in ABS cromato e ispezionabile, doccetta monogetto.

450,00 €

**76182CR**

Colonna Mari e Monti con tubazione in OTTONE Ø18, presa acqua special per installazione su rubinetto con alimentazione esterna e doppio flessibile, soffione BORA 200x200 in ABS cromato e ispezionabile, doccetta monogetto.

480,00 €

**76137CRV**

Colonna Mari e Monti con tubazione in OTTONE Ø18, termostatico, soffione ACCIAIO con valvola di sicurezza, doccetta monogetto.

200 X 200 557,00 €  
250 X 250 575,00 €  
300 X 300 590,00 €

**76197CRV**

Colonna Mari e Monti con tubazione in OTTONE Ø18, monocomando, soffione ACCIAIO con valvola di sicurezza, doccetta monogetto.

200 X 200 555,00 €  
250 X 250 571,00 €  
300 X 300 588,00 €

**76167CRV**

Colonna Mari e Monti con tubazione in OTTONE Ø18, presa acqua per installazione con incasso (non fornito), soffione ACCIAIO con valvola di sicurezza, doccetta monogetto.

200 X 200 458,00 €  
250 X 250 468,00 €  
300 X 300 485,00 €

**76162CRV**

Colonna Mari e Monti con tubazione in OTTONE Ø18, presa acqua special per installazione su rubinetto con alimentazione esterna e doppio flessibile, soffione ACCIAIO con valvola di sicurezza, doccetta monogetto.

200 X 200 490,00 €  
250 X 250 500,00 €  
300 X 300 515,00 €



con valvola di sicurezza

**76137CRE**

Colonna Mari e Monti con tubazione in OTTONE Ø18, termostatico, soffione ACCIAIO non ispezionabile, doccetta monogetto.

200 X 200 520,00 €  
250 X 250 545,00 €  
300 X 300 560,00 €

**76197CRE**

Colonna Mari e Monti con tubazione in OTTONE Ø18, monocomando, soffione ACCIAIO non ispezionabile, doccetta monogetto.

200 X 200 510,00 €  
250 X 250 530,00 €  
300 X 300 555,00 €

**76167CRE**

Colonna Mari e Monti con tubazione in OTTONE Ø18, presa acqua per installazione con incasso (non fornito), soffione ACCIAIO non ispezionabile, doccetta monogetto.

200 X 200 420,00 €  
250 X 250 451,00 €  
300 X 300 460,00 €

**76162CRE**

Colonna Mari e Monti con tubazione in OTTONE Ø18, presa acqua special per installazione su rubinetto con alimentazione esterna e doppio flessibile, soffione ACCIAIO non ispezionabile, doccetta monogetto.

200 X 200 450,00 €  
250 X 250 480,00 €  
300 X 300 490,00 €





colonna SNELLA con soffione ULTRAPIATTO - finitura cromo

## SNELLA T - SNELLA Q



**77131CR**  
SNELLA con SCIROCCO



**77136CR**  
SNELLA con ULTRAPIATTO



**77132CR**  
SNELLA con BORA



**77137CR**  
SNELLA con ULTRAPIATTO

 **CR** Cromo / Chrome

Tubazione spessore 1 mm.  
Scorrevole portadoccia in ABS cromato.

*Thickness tube 1 mm.  
ABS sliding bar shower holder.*



Design ufficio tecnico Aquaviva  
Design by Aquaviva's technical office



# SNELLA T

Rubinetteria tonda / Round taps

## Dettagli tecnici

Dettagli tecnici

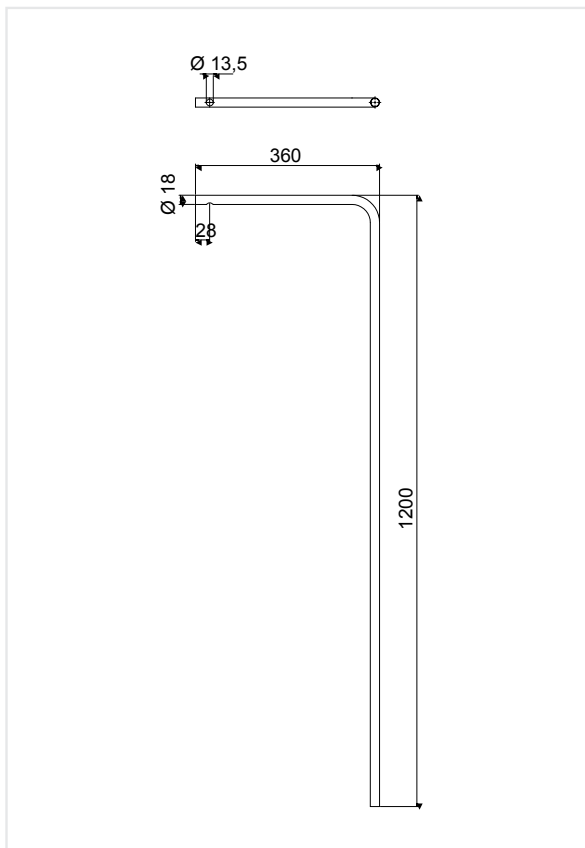

## Portasapone a richiesta

Soap tray on request



Possibilità di tagliare la tubazione.

*Possibility to adjust the height of the column.*

## COLONNA COMPLETA \_ COMPLETE SHOWER COLUMN

Finiture speciali su richiesta \_ Special finishing on request

COMBINAZIONI POSSIBILI  
POSSIBLE COMBINATIONS**77131CR**

Colonna Snella con tubazione in OTTONE Ø18, termostatico, soffione SCIROCCO Ø200 in ABS cromato e ispezionabile, doccetta monogetto.

540,00 €

**77191CR**

Colonna Snella con tubazione in OTTONE Ø18, monocomando, soffione SCIROCCO Ø200 in ABS cromato e ispezionabile, doccetta monogetto.

555,00 €

**77161CR**

Colonna Snella con tubazione in OTTONE Ø18, presa acqua per installazione con incasso (non fornito), soffione SCIROCCO Ø200 in ABS cromato e ispezionabile, doccetta monogetto.

440,00 €

**77181CR**

Colonna Snella con tubazione in OTTONE Ø18, presa acqua special per installazione su rubinetto con alimentazione esterna e doppio flessibile, soffione SCIROCCO Ø200 in ABS cromato e ispezionabile, doccetta monogetto.

470,00 €

**77136CRV**

Colonna Snella con tubazione in OTTONE Ø18, termostatico, soffione ACCIAIO con valvola di sicurezza, doccetta monogetto.

Ø200 555,00 €  
Ø250 571,00 €  
Ø300 587,00 €

**77196CRV**

Colonna Snella con tubazione in OTTONE Ø18, monocomando, soffione ACCIAIO con valvola di sicurezza, doccetta monogetto.

Ø200 553,00 €  
Ø250 569,00 €  
Ø300 585,00 €

**77166CRV**

Colonna Snella con tubazione in OTTONE Ø18, presa acqua per installazione con incasso (non fornito), soffione ACCIAIO con valvola di sicurezza, doccetta monogetto.

Ø200 449,00 €  
Ø250 465,00 €  
Ø300 481,00 €

**77186CRV**

Colonna Snella con tubazione in OTTONE Ø18, presa acqua special per installazione su rubinetto con alimentazione esterna e doppio flessibile, soffione ACCIAIO con valvola di sicurezza, doccetta monogetto.

Ø200 463,00 €  
Ø250 486,00 €  
Ø300 495,00 €



con valvola di sicurezza

**77136CRE**

Colonna Snella con tubazione in OTTONE Ø18, termostatico, soffione ACCIAIO non ispezionabile, doccetta monogetto.

Ø200 540,00 €  
Ø250 550,00 €  
Ø300 570,00 €

**77196CRE**

Colonna Snella con tubazione in OTTONE Ø18, monocomando, soffione ACCIAIO non ispezionabile, doccetta monogetto.

Ø200 530,00 €  
Ø250 540,00 €  
Ø300 560,00 €

**77166CRE**

Colonna Snella con tubazione in OTTONE Ø18, presa acqua per installazione con incasso (non fornito), soffione ACCIAIO non ispezionabile, doccetta monogetto.

Ø200 430,00 €  
Ø250 445,00 €  
Ø300 455,00 €

**77186CRE**

Colonna Snella con tubazione in OTTONE Ø18, presa acqua special per installazione su rubinetto con alimentazione esterna e doppio flessibile, soffione ACCIAIO non ispezionabile, doccetta monogetto.

Ø200 470,00 €  
Ø250 480,00 €  
Ø300 490,00 €

**77132CR**

Colonna Snella con tubazione in OTTONE Ø18, termostatico, soffione BORA 200x200 in ABS cromato e ispezionabile, doccetta monogetto.

565,00 €

**77192CR**

Colonna Snella con tubazione in OTTONE Ø18, monocomando, soffione BORA 200x200 in ABS cromato e ispezionabile, doccetta monogetto.

555,00 €

**77162CR**

Colonna Snella con tubazione in OTTONE Ø18, presa acqua per installazione con incasso (non fornito), soffione BORA 200x200 in ABS cromato e ispezionabile, doccetta monogetto.

455,00 €

**77182CR**

Colonna Snella con tubazione in OTTONE Ø18, presa acqua special per installazione su rubinetto con alimentazione esterna e doppio flessibile, soffione BORA 200x200 in ABS cromato e ispezionabile, doccetta monogetto.

485,00 €

**77137CRV**

Colonna Snella con tubazione in OTTONE Ø18, termostatico, soffione ACCIAIO con valvola di sicurezza, doccetta monogetto.

200 X 200 565,00 €  
250 X 250 575,00 €  
300 X 300 605,00 €

**77197CRV**

Colonna Snella con tubazione in OTTONE Ø18, monocomando, soffione ACCIAIO con valvola di sicurezza, doccetta monogetto.

200 X 200 555,00 €  
250 X 250 571,00 €  
300 X 300 600,00 €

**77167CRV**

Colonna Snella con tubazione in OTTONE Ø18, presa acqua per installazione con incasso (non fornito), soffione ACCIAIO con valvola di sicurezza, doccetta monogetto.

200 X 200 465,00 €  
250 X 250 480,00 €  
300 X 300 500,00 €

**77162CRV**

Colonna Snella con tubazione in OTTONE Ø18, presa acqua special per installazione su rubinetto con alimentazione esterna e doppio flessibile, soffione ACCIAIO con valvola di sicurezza, doccetta monogetto.

200 X 200 500,00 €  
250 X 250 510,00 €  
300 X 300 540,00 €



con valvola di sicurezza

**77137CRE**

Colonna Snella con tubazione in OTTONE Ø18, termostatico, soffione ACCIAIO non ispezionabile, doccetta monogetto.

200 X 200 555,00 €  
250 X 250 565,00 €  
300 X 300 595,00 €

**77197CRE**

Colonna Snella con tubazione in OTTONE Ø18, monocomando, soffione ACCIAIO non ispezionabile, doccetta monogetto.

200 X 200 545,00 €  
250 X 250 560,00 €  
300 X 300 590,00 €

**77167CRE**

Colonna Snella con tubazione in OTTONE Ø18, presa acqua per installazione con incasso (non fornito), soffione ACCIAIO non ispezionabile, doccetta monogetto.

200 X 200 455,00 €  
250 X 250 470,00 €  
300 X 300 490,00 €

**77162CRE**

Colonna Snella con tubazione in OTTONE Ø18, presa acqua special per installazione su rubinetto con alimentazione esterna e doppio flessibile, soffione ACCIAIO non ispezionabile, doccetta monogetto.

200 X 200 490,00 €  
250 X 250 500,00 €  
300 X 300 530,00 €



# SNELLA Q

Rubinetteria quadra / Square taps

## Dettagli tecnici

Dettagli tecnici

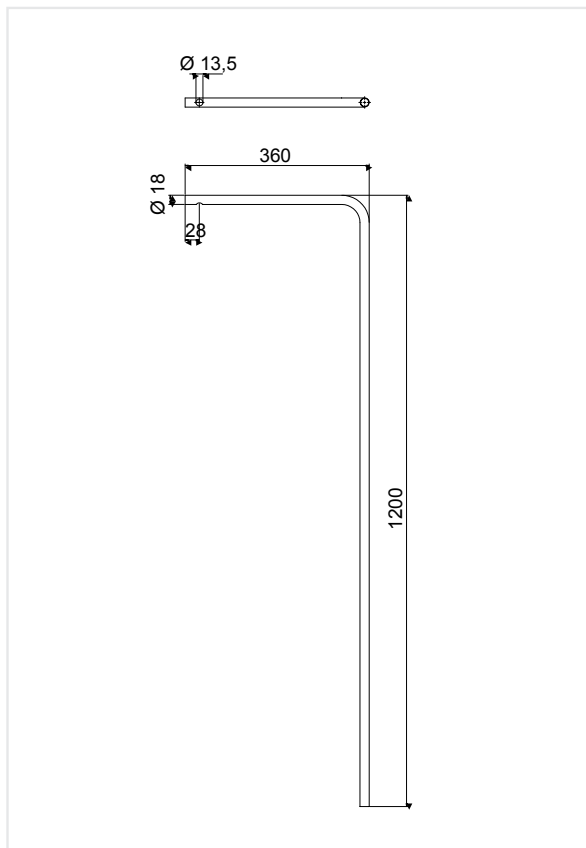

## Portasapone a richiesta

Soap tray on request



Possibilità di tagliare la tubazione.

*Possibility to adjust the eight of the column.*

## COLONNA COMPLETA \_ COMPLETE SHOWER COLUMN

Finiture speciali su richiesta \_ Special finishing on request

COMBINAZIONI POSSIBILI  
POSSIBLE COMBINATIONS**77138CR**

Colonna Snella con tubazione in OTTONE Ø18, termostatico, soffione BORA 200x200 in ABS cromato e ispezionabile, doccetta monogetto.

650,00 €

**77198CR**

Colonna Snella con tubazione in OTTONE Ø18, monocomando, soffione BORA 200x200 in ABS cromato e ispezionabile, doccetta monogetto.

620,00 €

**77168CR**

Colonna Snella con tubazione in OTTONE Ø18, presa acqua per installazione con incasso (non fornito), soffione BORA 200x200 in ABS cromato e ispezionabile, doccetta monogetto.

460,00 €

**77188CR**

Colonna Snella con tubazione in OTTONE Ø18, presa acqua special per installazione su rubinetto con alimentazione esterna doppio flessibile, soffione BORA 200x200 in ABS cromato e ispezionabile, doccetta monogetto.

510,00 €

**77139CRV**

Colonna Snella con tubazione in OTTONE Ø18, termostatico, soffione ACCIAIO con valvola di sicurezza, doccetta monogetto.

200 X 200 650,00 €  
250 X 250 660,00 €  
300 X 300 690,00 €

**77199CRV**

Colonna Snella con tubazione in OTTONE Ø18, monocomando, soffione ACCIAIO con valvola di sicurezza, doccetta monogetto.

200 X 200 620,00 €  
250 X 250 630,00 €  
300 X 300 660,00 €

**77169CRV**

Colonna Snella con tubazione in OTTONE Ø18, presa acqua per installazione con incasso (non fornito), soffione ACCIAIO con valvola di sicurezza, doccetta monogetto.

200 X 200 470,00 €  
250 X 250 480,00 €  
300 X 300 500,00 €

**77189CRV**

Colonna Snella con tubazione in OTTONE Ø18, presa acqua special per installazione su rubinetto con alimentazione esterna doppio flessibile, soffione ACCIAIO con valvola di sicurezza, doccetta monogetto.

200 X 200 510,00 €  
250 X 250 530,00 €  
300 X 300 560,00 €

**77139CRE**

Colonna Snella con tubazione in OTTONE Ø18, termostatico, soffione ACCIAIO non ispezionabile, doccetta monogetto.

200 X 200 640,00 €  
250 X 250 650,00 €  
300 X 300 680,00 €

**77199CRE**

Colonna Snella con tubazione in OTTONE Ø18, monocomando, soffione ACCIAIO non ispezionabile, doccetta monogetto.

200 X 200 610,00 €  
250 X 250 620,00 €  
300 X 300 650,00 €

**77169CRE**

Colonna Snella con tubazione in OTTONE Ø18, presa acqua per installazione con incasso (non fornito), soffione ACCIAIO non ispezionabile, doccetta monogetto.

200 X 200 460,00 €  
250 X 250 470,00 €  
300 X 300 490,00 €

**77189CRE**

Colonna Snella con tubazione in OTTONE Ø18, presa acqua special per installazione su rubinetto con alimentazione esterna doppio flessibile, soffione ACCIAIO non ispezionabile, doccetta monogetto.

200 X 200 500,00 €  
250 X 250 520,00 €  
300 X 300 550,00 €



con valvola di sicurezza





colonna ICE con soffione ULTRAPIATTO - finitura cromo

# ICE



**CO35178CR**



**CO35179CR**

**CR** Cromo | Chrome

**NE** Nero | Black

Tubazione spessore 1 mm. Scorrevole portadoccia in ABS cromato, telescopica e orientabile.

*Thickness tube 1 mm. ABS sliding bar shower holder. TELESCOPIC AND SWIVELING.*



Design ufficio tecnico Aquaviva  
Design by Aquaviva's technical office



## Dettagli tecnici

Dettagli tecnici

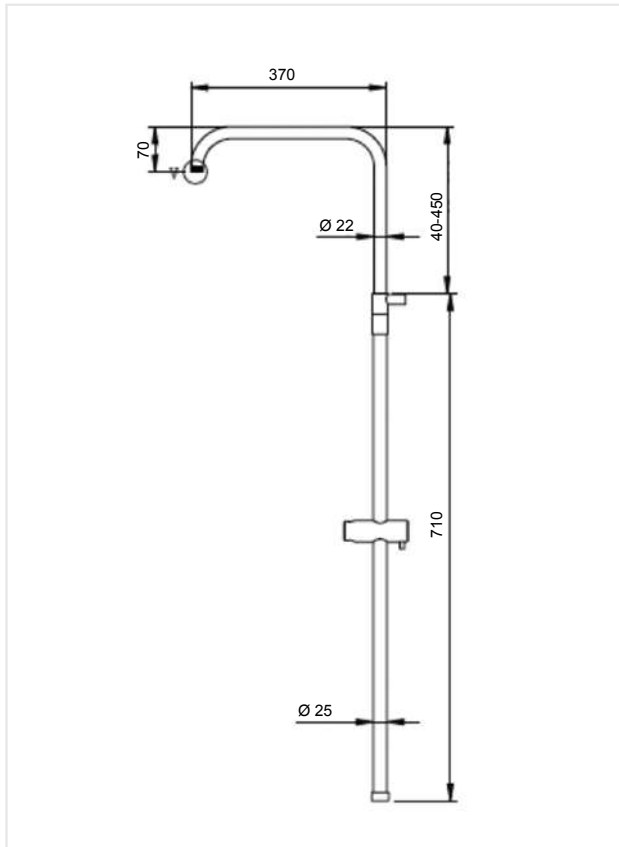

I soffioni sono disponibili anche con  $\varnothing 20$ .  
*The shower-heads are also available with  $\varnothing 20$ .*

# COLONNA COMPLETA \_ COMPLETE SHOWER COLUMN

Finiture speciali su richiesta \_ Special finishing on request

COMBINAZIONI POSSIBILI  
POSSIBLE COMBINATIONS



## CO35178CR

Colonna ICE con tubazione in OTTONE Ø25, telescopica e orientabile, con termostatico, soffione ABS Ø200, doccetta monogetto.

495,00 €

## CO35198CR

Colonna ICE con tubazione in OTTONE Ø25, telescopica e orientabile, con monocomando, soffione ABS Ø200, doccetta monogetto.

490,00 €

## CO35168CR

Colonna ICE con tubazione in OTTONE Ø25, telescopica e orientabile, con presa acqua per installazione con incasso (non fornito), soffione ABS Ø200, doccetta monogetto.

420,00 €

## CO35128CR

Colonna ICE con tubazione in ottone Ø18, presa acqua per installazione su rubinetto con alimentazione esterna e doppio flessibile, soffione Scirocco Ø200 in abs cromato e ispezionabile, doccetta monogetto.

455,00 €



## CO35179CR

Colonna ICE con tubazione in OTTONE Ø25, telescopica e orientabile, con termostatico, soffione ABS 200x200, doccetta monogetto.

520,00 €

## CO35199CR

Colonna ICE con tubazione in OTTONE Ø25, telescopica e orientabile, con monocomando, soffione ABS 200x200, doccetta monogetto.

515,00 €

## CO35169CR

Colonna ICE con tubazione in OTTONE Ø25, telescopica e orientabile, con presa acqua per installazione con incasso (non fornito), soffione ABS 200x200, doccetta monogetto.

445,00 €

## CO35129CR

Colonna ICE con tubazione in ottone Ø18, presa acqua per installazione su rubinetto con alimentazione esterna e doppio flessibile, soffione ABS con valvola di sicurezza, doccetta monogetto.

480,00 €



## CO35172CRV

Colonna ICE con tubazione in OTTONE Ø25, telescopica e orientabile, con termostatico, soffione ACCIAIO con valvola di sicurezza Ø250, doccetta monogetto.

Ø200 500,00 €  
Ø250 515,00 €  
Ø300 545,00 €

## CO35192CRV

Colonna ICE con tubazione in OTTONE Ø25, telescopica e orientabile, con monocomando, soffione ACCIAIO con valvola di sicurezza Ø250, doccetta monogetto.

Ø200 495,00 €  
Ø250 510,00 €  
Ø300 540,00 €

## CO35162CRV

Colonna ICE con tubazione in OTTONE Ø25, telescopica e orientabile, con presa acqua per installazione con incasso (non fornito), soffione ACCIAIO con valvola di sicurezza Ø250, doccetta monogetto.

Ø200 430,00 €  
Ø250 445,00 €  
Ø300 480,00 €

## CO35122CRV

Colonna Ice con tubazione in OTTONE Ø18, presa acqua special per installazione su rubinetto con alimentazione esterna e doppio flessibile, soffione ACCIAIO con valvola di sicurezza, doccetta monogetto.

Ø200 470,00 €  
Ø250 485,00 €  
Ø300 520,00 €



con valvola di sicurezza



## CO35172CRE

Colonna ICE con tubazione in OTTONE Ø25, telescopica e orientabile, con termostatico, soffione ACCIAIO, doccetta monogetto.

Ø200 490,00 €  
Ø250 510,00 €  
Ø300 535,00 €

## CO35192CRE

Colonna ICE con tubazione in OTTONE Ø25, telescopica e orientabile, con monocomando, soffione ACCIAIO, doccetta monogetto.

Ø200 485,00 €  
Ø250 500,00 €  
Ø300 530,00 €

## CO35162CRE

Colonna ICE con tubazione in OTTONE Ø25, telescopica e orientabile, con presa acqua per installazione con incasso (non fornito), soffione ACCIAIO, doccetta monogetto.

Ø200 420,00 €  
Ø250 435,00 €  
Ø300 470,00 €

## CO35122CRE

Colonna ICE con tubazione in ottone Ø18, presa acqua per installazione su rubinetto con alimentazione esterna e doppio flessibile, soffione ACCIAIO, doccetta monogetto.

Ø200 460,00 €  
Ø250 475,00 €  
Ø300 510,00 €



con valvola di sicurezza



## CO35179CRV

Colonna ICE con tubazione in OTTONE Ø25, telescopica e orientabile, con termostatico, soffione ACCIAIO con valvola di sicurezza, doccetta monogetto.

200 X 200 525,00 €  
250 X 250 540,00 €  
300 X 300 570,00 €

## CO35199CRV

Colonna ICE con tubazione in OTTONE Ø25, telescopica e orientabile, con monocomando, soffione ACCIAIO con valvola di sicurezza, doccetta monogetto.

200 X 200 520,00 €  
250 X 250 535,00 €  
300 X 300 575,00 €

## CO35169CRV

Colonna ICE con tubazione in OTTONE Ø25, telescopica e orientabile, con presa acqua per installazione con incasso (non fornito), soffione ACCIAIO con valvola di sicurezza, doccetta monogetto.

200 X 200 450,00 €  
250 X 250 465,00 €  
300 X 300 495,00 €

## CO35121CRV

Colonna ICE con tubazione in ottone Ø18, presa acqua per installazione su rubinetto con alimentazione esterna e doppio flessibile, soffione ACCIAIO con valvola di sicurezza, doccetta monogetto.

200 X 200 485,00 €  
250 X 250 500,00 €  
300 X 300 530,00 €



## CO35179CRE

Colonna ICE con tubazione in OTTONE Ø25, telescopica e orientabile, con termostatico, soffione ACCIAIO non ispezionabile, doccetta monogetto.

200 X 200 515,00 €  
250 X 250 530,00 €  
300 X 300 560,00 €

## CO35199CRE

Colonna ICE con tubazione in OTTONE Ø25, telescopica e orientabile, con monocomando, soffione ACCIAIO non ispezionabile, doccetta monogetto.

200 X 200 510,00 €  
250 X 250 525,00 €  
300 X 300 565,00 €

## CO35169CRE

Colonna ICE con tubazione in OTTONE Ø25, telescopica e orientabile, con presa acqua per installazione con incasso (non fornito), soffione ACCIAIO non ispezionabile, doccetta monogetto.

200 X 200 440,00 €  
250 X 250 450,00 €  
300 X 300 490,00 €

## CO35121CRE

Colonna ICE con tubazione in ottone Ø18, presa acqua per installazione su rubinetto con alimentazione esterna e doppio flessibile, soffione ACCIAIO non ispezionabile, doccetta monogetto.

200 X 200 475,00 €  
250 X 250 490,00 €  
300 X 300 520,00 €



cod. **66080CR**

Presa acqua per colonna tonda 2 vie.  
*2-ways water supply for round column.*



cod. **66090CR**

Presa acqua per colonna quadra a 2 vie.  
*2-ways water supply for square column.*



126,00 €



146,00 €



cod. **66022CR**

Presa acqua special tonda per alimentazione esterna.  
*Special water supply for external water inlet.*



cod. **66095CR**

Presa acqua special quadraper alimentazione esterna.  
*Special water supply for external water inlet.*



140,00 €



185,00 €



cod. **66020CR**

Presa acqua in ottone cromato per installazione con gruppo vasca.  
*Chromed brass water supply for installation with exposed bath mixer.*



cod. **66010CR**

Presa acqua in ottone cromato per installazione con monocomando incasso.  
*Chromed brass water supply for installation with concealed shower mixer.*



69,00 €



68,00 €



cod. **66060CR**

Deviatore in ottone cromato completo di raccordi per colonna.  
*Chromed brass diverter with connections for column.*

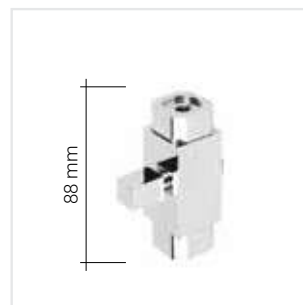

cod. **66064CR**

Deviatore in ottone cromato completo di raccordi per colonna.  
*Chromed brass diverter with connections for column.*



51,00 €



79,00 €

cod. **66000CR**

Portasapone in ottone cromato per Ø 18 mm.  
*Chromed brass soap tray for Ø 18 mm.*



156x88 mm

**50,00 €**cod. **66070CR**

Portasapone in ottone cromato per Ø 18 mm.  
*Chromed brass soap tray for Ø 18 mm.*



Ø 100 mm

**50,00 €**cod. **50261TVT**

Portasapone in metacrilato trasparente speciale per colonne con tubazione Ø 18 mm, fornito con doppio supporto a muro.  
*Soap shelf, transparent methacrylate, round section Ø 18 mm.*



310x135 mm

**76,00 €**

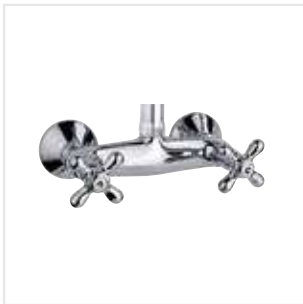

cod. **66165CR**



Gruppo classico.  
Interasse 160 mm.  
*Classic group.*  
*Interaxis distance 160 mm.*



cod. **66133CR**



Gruppo monocomando  
esterno per colonna.  
Interasse 150 mm.  
*Mixer for columns.*  
*Interaxis distance 150 mm.*



144,00 €



133,00 €



cod. **66134CR**



Gruppo monocomando  
moderno da fusione  
per colonna.  
Interasse 150 mm.  
*Mixer for modern columns.*  
*Interaxis distance 150 mm.*



cod. **66131CR**



Monocomando quadro per  
colonna. Interasse 150 mm.  
*Square mixer for columns.*  
*Interaxis distance 150 mm.*



192,00 €



318,00 €



cod. **66400CR**



Termostatico MINIMAL con  
deviatore integrato tondo per  
colonna. Interasse 150 mm.  
*MINIMAL thermostatic mixer*  
*with integrated diverter for*  
*column. Interaxis distance*  
*150 mm.*



cod. **66100CR**



Termostatico tondo da barra  
con deviatore integrato per  
colonna. Interasse 150 mm.  
*Round thermostatic mixer*  
*with integrated diverter for*  
*columns. Interaxis distance*  
*150 mm.*



232,00 €



316,00 €



cod. **66300CR**



Termostatico da barra quadro  
con deviatore integrato per  
colonna. Interasse 150 mm.  
*Square thermostatic mixer*  
*with integrated diverter for*  
*columns. Interaxis distance*  
*150 mm.*



cod. **66500CR**



Termostatico quadro  
MINIMAL con deviatore  
integrato per colonna.  
Interasse 150 mm.  
*MINIMAL square thermostatic*  
*mixer with integrated diverter*  
*for columns. Interaxis*  
*distance 150 mm.*



430,00 €



370,00 €

**65300CRT** ○

Cartuccia termostatica completa di maniglia cromata.  
*Thermostatic valve with chrome handle.*

**80,00 €****65300CRD**

Cartuccia deviatrice completa di maniglia cromata.  
*Diverter valve with chrome handle.*

**80,00 €****65006**

Cartuccia deviatrice in ottone (senza maniglia).  
*Brass diverter valve (without handle).*

**46,00 €****65301CRT** ○

Cartuccia termostatica minimal completa di maniglia cromata.  
*Thermostatic valve with chrome handle.*

**80,00 €****65301CRD**

Cartuccia deviatrice minimal completa di maniglia cromata.  
*Minimal diverter valve with chrome handle.*

**80,00 €****65006**

Cartuccia deviatrice in ottone (senza maniglia).  
*Brass diverter valve (without handle).*

**46,00 €****65302CRT** □

Cartuccia termostatica completa di maniglia in metallo cromata.  
*Thermostatic valve with chrome handle.*

**92,00 €****65302CRD**

Cartuccia deviatrice completa di maniglia in metallo cromata.  
*Diverter valve with chrome handle.*

**92,00 €****65006**

Cartuccia deviatrice in ottone (senza maniglia).  
*Brass diverter valve (without handle).*

**46,00 €****65304CRT** ○

Cartuccia termostatica minimal completa di maniglia in metallo cromata.  
*Thermostatic valve with chrome handle.*

**80,00 €****65304CRD**

Cartuccia deviatrice minimal completa di maniglia in metallo cromata.  
*Minimal diverter valve with chrome handle.*

**80,00 €****65007**

Cartuccia deviatrice in ABS (senza maniglia).  
*ABS diverter valve (without handle).*

**38,00 €**

#### CARATTERISTICHE TECNICHE TERMOSTATICO THERMOSTATIC TECHNICAL CHARACTERISTICS

Temperatura di utilizzo   <i>Operating temperature</i>	5°- 80° C
Gamma di regolazione della temperatura con ghiera graduata <i>Temperature setting range with graduated ring nut</i>	20°÷ 50° C
Temperatura per risparmio energetico <i>Temperature for energy saving</i>	60° C
Pressione di utilizzo   <i>Operating pressure</i>	da 0,5 a 10 Bar
Pressione raccomandata   <i>Recommended pressure</i>	da 1 a 4 Bar
Fermo di sicurezza   <i>Safety catch</i>	38° C
Scala graduata manopola   <i>Handle graduated scale</i>	da 20° a 50° C
Portata   <i>Flow rate</i>	3 Bar 30 l/min

Interruzione flusso acqua: in caso di guasto idraulico garantisce l'interruzione del flusso d'acqua. Costanza temperatura: garanzia di temperatura costante con il variare della pressione dell'acqua.

*Water flow interruption: in case of hydraulic failure it guarantees the interruption of the water flow. Constant temperature: guarantee of constant temperature with water pressure variation.*

**65250**

Ricambio cartuccia monocomando Ø35 (bassa o alta).  
*Spare parts single lever Ø35 (low or high).*

**26,00 €****65251**

Ricambio cartuccia monocomando Ø40 (bassa o alta).  
*Spare parts single lever Ø40 (low or high).*

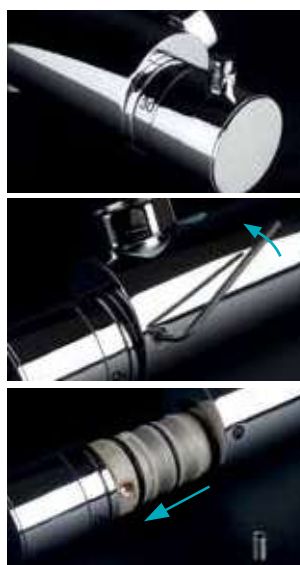
**37,00 €**

Corpo termostatico tornito da barra di ottone cromato di nostra produzione. Facilità e semplicità di sostituzione cartuccia. Si raccomanda di estrarre la cartuccia con la manopola montata per evitare di perdere la taratura  
*Chromed thermostatic body, brass bar turned, of our production. Easy replacement of the cartridge.*

**MANTERABS**







Ricambio solo manopola in ABS | *ABS spare parts only handle*







**14,00 €****MANTERMET**







Ricambio solo manopola in metallo | *Metal spare parts only handle*

**23,00 €**

## COME ORDINARE UNA COLONNA DOCCIA \_ HOW TO ORDER A SHOWER COLUMN

		<b>DELTA</b> Ø 20 ACCIAIO INOX	<b>SCIROCCO</b> Ø 20 ABS	<b>PENELOPE</b> Ø 20 ACCIAIO INOX
				
Senza rubinetto		<b>38101CR</b> 532,00 €	<b>38109CR</b> 393,00 €	<b>38104CR</b> 494,00 €
Termostatico da barra		<b>38131CR</b> 782,00 €	<b>38139CR</b> 643,00 €	<b>38134CR</b> 744,00 €
Termostatico MINIMAL		<b>38171CR</b> 706,00 €	<b>38179CR</b> 567,00 €	<b>38174CR</b> 668,00 €
Gruppo monocomando		<b>38121CR</b> 710,00 €	<b>38129CR</b> 571,00 €	<b>38124CR</b> 672,00 €
Pres a acqua c/ deviatore integrato		<b>38161CR</b> 602,00 €	<b>38169CR</b> 463,00 €	<b>38164CR</b> 564,00 €
Pres a acqua tonda special		<b>38061CR</b> 615,00 €	<b>38069CR</b> 476,00 €	<b>38064CR</b> 577,00 €

		<b>DELTA</b> Ø 20 ACCIAIO INOX	<b>SCIROCCO</b> Ø 20 ABS	<b>PENELOPE</b> Ø 20 ACCIAIO INOX
				
Senza rubinetto		<b>38101CR</b> 532,00 €	<b>38109CR</b> 393,00 €	<b>38104CR</b> 494,00 €
Termostatico da barra		<b>38131CR</b> 782,00 €	<b>38139CR</b> 643,00 €	<b>38134CR</b> 744,00 €
Termostatico MINIMAL		<b>38171CR</b> 706,00 €	<b>38179CR</b> 567,00 €	<b>38174CR</b> 668,00 €
Gruppo monocomando		<b>38121CR</b> 710,00 €	<b>38129CR</b> 571,00 €	<b>38124CR</b> 672,00 €
Pres a acqua c/ deviatore integrato		<b>38161CR</b> 602,00 €	<b>38169CR</b> 463,00 €	<b>38164CR</b> 564,00 €
Pres a acqua tonda special		<b>38061CR</b> 615,00 €	<b>38069CR</b> 476,00 €	<b>38064CR</b> 577,00 €

		<b>DELTA</b> Ø 20 ACCIAIO INOX	<b>SCIROCCO</b> Ø 20 ABS	<b>PENELOPE</b> Ø 20 ACCIAIO INOX
				
Senza rubinetto		<b>38101CR</b> 532,00 €	<b>38109CR</b> 393,00 €	<b>38104CR</b> 494,00 €
Termostatico da barra		<b>38131CR</b> 782,00 €	<b>38139CR</b> 643,00 €	<b>38134CR</b> 744,00 €
Termostatico MINIMAL		<b>38171CR</b> 706,00 €	<b>38179CR</b> 567,00 €	<b>38174CR</b> 668,00 €
Gruppo monocomando		<b>38121CR</b> 710,00 €	<b>38129CR</b> 571,00 €	<b>38124CR</b> 672,00 €
Pres a acqua c/ deviatore integrato		<b>38161CR</b> 602,00 €	<b>38169CR</b> 463,00 €	<b>38164CR</b> 564,00 €
Pres a acqua tonda special		<b>38061CR</b> 615,00 €	<b>38069CR</b> 476,00 €	<b>38064CR</b> 577,00 €

### 1

Scegliere il modello di **rubinetto** desiderato tra quelli proposti.

Esempio: Termostatico da barra

*Choose the desired **tap** among the models proposed.*  
*For example: Thermostatic mixer*

### 2

Scegliere il modello di **soffione** desiderato tra i modelli da noi proposti nei diversi materiali:

- ABS cromato
- Acciaio inox
- Ottone cromato

Esempio: Soffione disco Ø 20 cm

*Choose the desired **shower head** among the models proposed in the different materials:*

- Chromed ABS
- Stainless steel
- Chromed brass

*For example: Disco Ø 20 cm shower head*

### 3

Incrociare quanto evidenziato e indicare il codice corrispondente per la trasmissione dell'ordine.

Esempio: codice ordine

**38139CR** = Monocomando da barra + soffione disco Ø 20 cm

*Crossing these informations, find corresponding code*

*For example:*

**38139CR** = Mixer + disco Ø 20 cm shower head

NOTA: È possibile cambiare modello soffione o doccia scegliendo tra altri articoli inseriti nei capitoli dedicati.

NOTE: It is possible to replace the shower head or the hand shower with the models listed in the related sections.

## ESEMPI COMBINAZIONI DOCCIA \_ EXAMPLE OF COMBINATIONS

TONDO  
ROUNDQUADRO  
SQUARE

## COLONNA SENZA RUBINETTO:

Colonna completa dotata di soffione, portadoccetta, doccia, flessibile 150 cm, deviatore con attacco 1/2" o 3/4" per installazione su miscelatore esterno con uscita superiore.

## SHOWER COLUMN WITHOUT TAP:

Shower column equipped with shower head, hand shower holder, hand shower, flexible hose 150 cm, diverter with connection 1/2" or 3/4" for installation on external mixer with upper output.

THERMOSTATICO DA BARRA  
THERMOSTATIC MIXERTHERMOSTATICO MINIMAL  
MINIMAL THERMOSTATIC MIXER

## COLONNA CON MISCELATORE THERMOSTATICO:

Colonna completa dotata di soffione, portadoccetta, doccia, flessibile 150 cm, miscelatore termostatico con deviatore integrato.

## SHOWER COLUMN WITH THERMOSTATIC MIXER:

Shower column equipped with shower head, hand shower holder, hand shower, flexible hose 150 cm, thermostatic mixer with integrated diverter.

GRUPPO MONOCOMANDO ESTERNO  
EXTERNAL MIXERGRUPPO CLASSICO  
CLASSIC GROUP

## COLONNA CON MISCELATORE:

Colonna completa dotata di soffione, portadoccetta, doccia, flessibile 150 cm, miscelatore e deviatore esterno.

## SHOWER COLUMN WITH MIXER:

Shower column equipped with shower head, hand shower holder, hand shower, flexible hose 150 cm, mixer and external diverter.

## ESEMPI COMBINAZIONI DOCCIA \_ EXAMPLE OF COMBINATIONS



PRESA ACQUA TONDA  
ROUND WATER SUPPLY



PRESA ACQUA QUADRA  
SQUARE WATER SUPPLY

### COLONNA CON PRESA ACQUA:

Colonna dotata di soffione, porta-doccetta, doccia, flessibile 150 cm, presa acqua con deviatore integrato per installazione su uscita dell'acqua a muro e con miscelatore incasso già esistente.

### SHOWER COLUMN WITH WATER SUPPLY:

Shower column equipped with shower head, hand shower holder, hand shower, flexible hose 150 cm and water supply with integrated diverter for installation with built-in mixer not included.



PRESA ACQUA SPECIAL TONDA  
SPECIAL ROUND WATER SUPPLY



PRESA ACQUA SPECIAL QUADRA  
SPECIAL SQUARE WATER SUPPLY

### COLONNA con presa acqua SPECIAL:

Colonna dotata di soffione, porta-doccetta, doccia, flessibile 150 cm, supporto a muro con deviatore integrato e collegamento flessibile 40 cm per prelievo dell'acqua dall'uscita a muro o dal gruppo vasca.

### SHOWER COLUMN WITH SPECIAL WATER SUPPLY:

Shower column equipped with shower head, hand shower holder, hand shower, flexible hose 150 cm, special water supply with integrated diverter and connection to wall outlet or bath mixer trough flexible hose 40 cm.

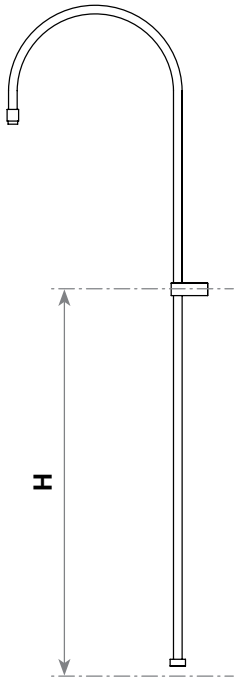

		H
COLONNA COMPLETA SHOWER COLUMN	gruppo moderno modern group	985
	termostatico thermostatic	920
	monocomando mixer	990
	presa acqua water supply	915
COLONNA SENZA RUBINETTO COLUMN WITHOUT TAP		950

Per l'installazione ideale della colonna doccia il soffione deve essere ad un'altezza di circa 2000 mm da terra (intendendo la distanza compresa tra il lato inferiore del soffione ed il piatto doccia). Prima di iniziare il montaggio della colonna doccia vi consigliamo quindi di verificare le quote ed i collegamenti del vostro ambiente bagno, considerando che alcune colonne doccia possono essere personalizzate in altezza.

- 1) Verificare l'altezza massima del vostro ambiente bagno considerando che il prodotto completo, nel suo sviluppo ideale, occupa un'altezza da terra di circa 2250 mm.
- 2) È importante verificare che il sistema di connessione della colonna alla rubinetteria da voi prevista sia corrispondente. Per l'installazione delle colonne Aquaviva il rubinetto (miscelatore, termostatico o tradizionale) deve trovarsi ad un'altezza da terra di circa 1100 mm (per doccia) e di 750 mm (per vasca).

*To obtain an ideal shower column installation, the shower head should be positioned at a height of 2000 mm from the floor (i.e. distance between the lower side of the shower head and the shower tray).*

*Therefore, before installing the shower column, you are advised to check the dimensions and the connections in your bathroom, considering that some models of shower columns can be customized.*

*1) Check the maximum height of your bathroom, taking into account that the ideal overall product dimensions reach a height of 2250 mm from the floor.*

*2) It is important to check the connection system of your tap fittings. Top install the Aquaviva column, the shower taps (mixer, thermostatic or traditional) must be at a height of not less than 1100 mm from the floor for the shower cubicle and not less than 750 mm for the bathtub.*

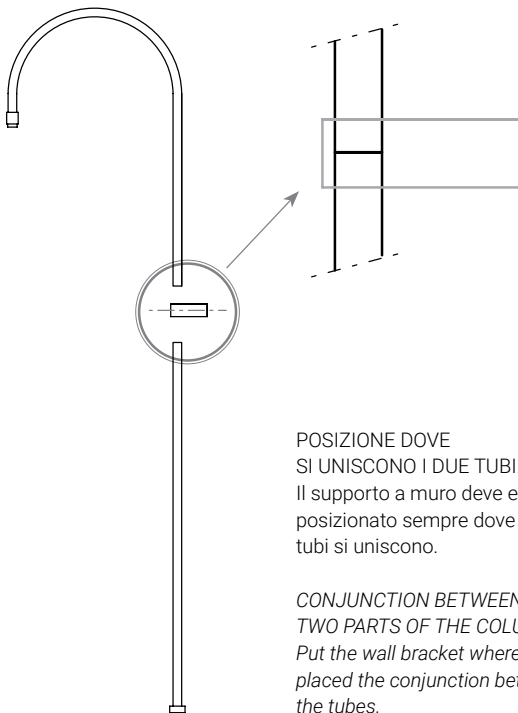

POSIZIONE DOVE SI UNISCONO I DUE TUBI.  
Il supporto a muro deve essere posizionato sempre dove i due tubi si uniscono.

CONJUNCTION BETWEEN THE TWO PARTS OF THE COLUMN.  
Put the wall bracket where is placed the conjunction between the tubes.

# ISTRUZIONI DI MONTAGGIO \_ INSTALLATION INSTRUCTIONS

DOCCIA  
SHOWER

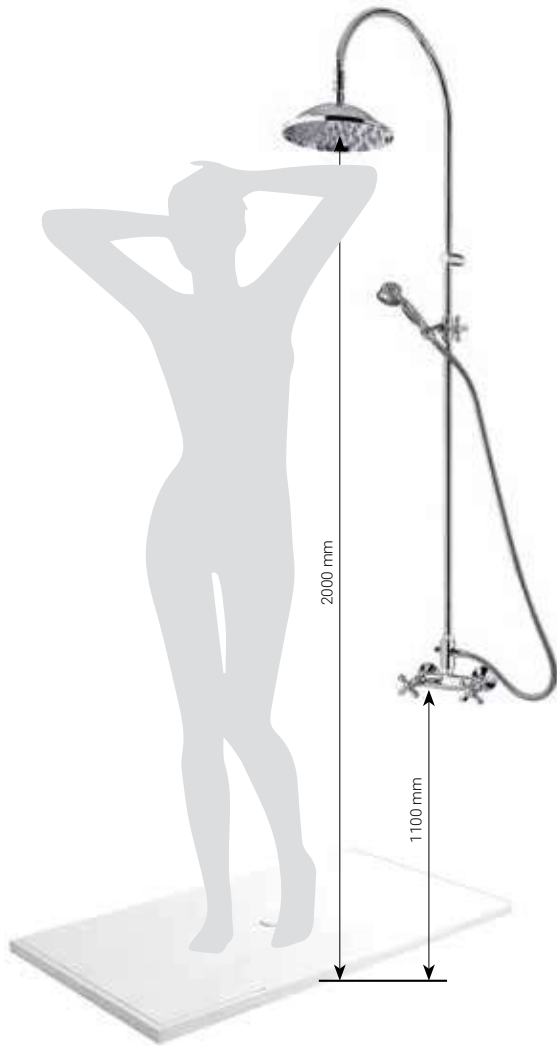

VASCA  
BATHTUB

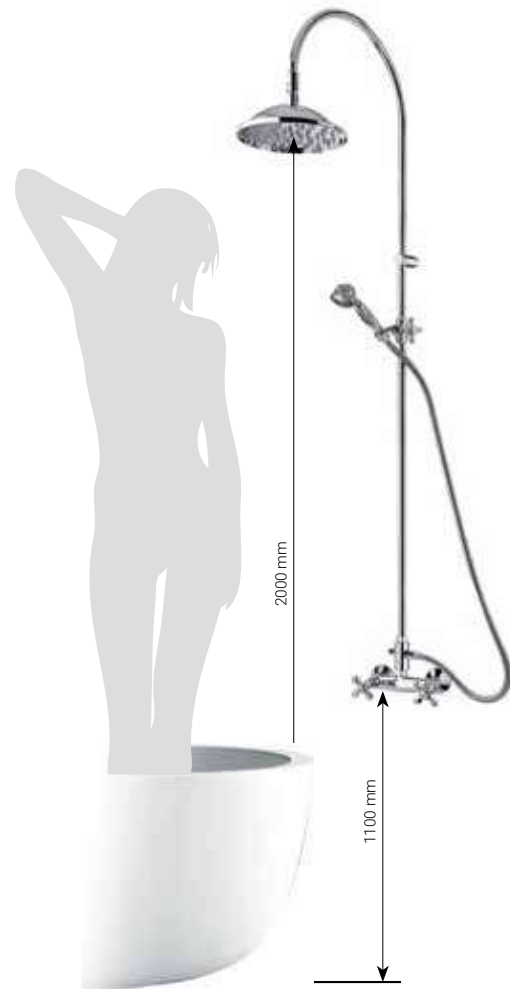

Altezza ottimale di collocazione  
in base all'altezza della persona.  
*Man-height column installation.*

**H** : altezza uomo / man-height

cm    160    170    180    190    200

**A** : posizione colonna doccia / shower column position



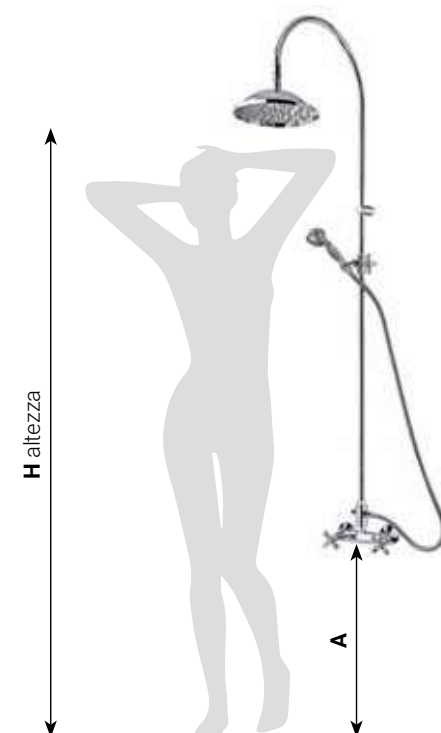

cm    90    100    110    115    120

misura standard



# WELLNESS & OUTDOOR

FINITURE SPECIALI SU RICHIESTA:  
SPECIAL FINISHING ON REQUEST:

-  **OR** Oro | Gold
-  **VO** Vecchio Ottone | Old Brass
-  **VR** Vecchio Rame | Old Copper
-  **NS** Nickel Spazzolato | Satin Nickel
-  **NE** Nero | Black

Sugli articoli in finitura speciale si potrebbero presentare delle imperfezioni, dovute al tipo di lavorazione.  
*Please kindly note that on items in special finishing you may have imperfections due to the type of machining.*





# CROMOTERAPIA

Soffioni con cromoterapia | Shower heads with chromotherapy

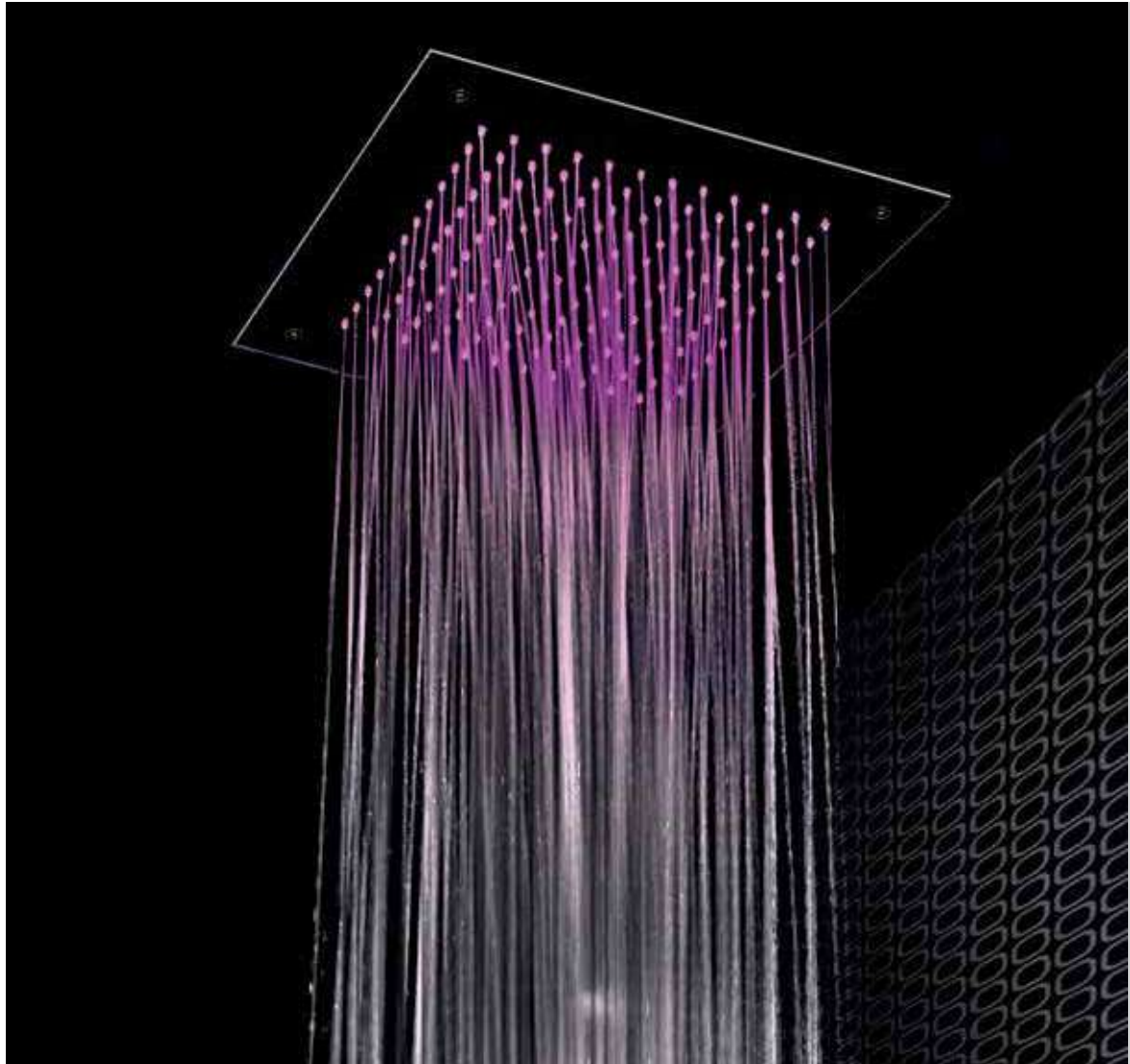

BIANCO / WHITE

Rivitalizzante, aumenta la vitalità e l'energia.  
*Revitalizing, increases vitality and energy.*

CIANO / CYAN

Calmante, scioglie la tensione e dona freschezza.  
*Soothing, it releases tension and restores freshness.*

GLICINE / MAUVE

Rilassante, cura l'insonnia e il sistema nervoso.  
*Relaxing, helps with insomnia and the nervous system.*

GIALLO / YELLOW

Stimolante, favorisce la concentrazione e dona sicurezza.  
*Stimulating, favours concentration and self assurance.*

VERDE / GREEN

Rilassante, favorisce riflessione e calma.  
*Relaxing, favours contemplation and calmness.*

BLU / BLUE

Purificante, cura lo stress e l'ansia.  
*Purifying, against stress and anxiety.*

MAGENTA

Energetico, dona vigore.  
*Energetic, it confers strength and character.*

ARANCIO / ORANGE

Liberante, dona ottimismo e scioglie le tensioni.  
*Freeing, it confers optimism and releases tension.*

ROSSO / RED

Stimolante, eccitante, cura depressione e immunodeficienze.  
*Stimulating, exciting, against depression and immune-deficiency.*

Si può disporre di 11 programmi per i benefici della cromoterapia.  
*You can have 11 programs for the benefits of chromotherapy.*



### CROMOTERAPIA OUT BANDE LED



Soffione in acciaio inox 500x500mm con cromoterapia tre funzioni (bande led).  
Stainless steel shower head 500x500mm with chromotherapy three functions (led stripes).



IP54

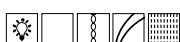

CT95244

Cromo | Chrome 144 LED

500X500 mm

€ 2.370,00 €



### CROMOTERAPIA OUT LED UGELLI



Soffione in acciaio inox 500x500mm con cromoterapia 3 funzioni (led ugelli).  
Stainless steel shower head 500x500mm with chromotherapy three functions (led nozzles).



IP54



CT93144

Cromo | Chrome

500x500 mm

3.350,00 €



### CROMOTERAPIA IN



Soffione in acciaio inox 580x580mm una funzione con perimetro a led.  
Stainless steel shower head 580x580mm one function with led perimeter.



IP54



VB58581

Cromo | Chrome 144 LED

580X580 mm

4.560,00 €

# CROMOTERAPIA



## CROMOTERAPIA IN



Soffione in acciaio inox 580x580mm due funzioni con perimetro a led e cascata.  
*Stainless steel shower head 580x580mm two functions with led perimeter and waterfall.*



IP54



**VB58582**

Cromo | Chrome 144 LED

580x580 mm

**4.900,00 €**



## CROMOTERAPIA IN



Soffione in acciaio inox 580x580mm tre funzioni con perimetro a led, cascata e idrogetto.  
*Stainless steel shower head 580x580mm three functions with led perimeter, waterfall and pump-jet.*



IP54

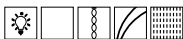

**VB58583**

Cromo | Chrome 144 LED

580x580 mm

**4.980,00 €**

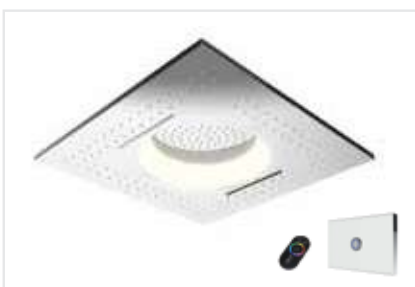

## CROMOTERAPIA OUT



Soffione in acciaio inox 630x630mm cinque funzioni con led tondo ad incasso.  
*Stainless steel shower head 630x630mm five functions with round built-in led.*



IP54

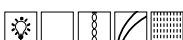

**VB6363**

Cromo | Chrome 144 LED

630x630 mm

**5.770,00 €**



# CROMOTERAPIA



## CROMOTERAPIA IN



Soffione in acciaio inox 950x950mm con cromoterapia quattro funzioni.  
Stainless steel shower head 950x950mm with chromotherapy four functions.



IP54

**CT37144**

Cromo | Chrome 144 LED

950x950 mm

**4.530,00 €**



## CROMOTERAPIA IN



Soffione in acciaio inox 580x480mm due funzioni con perimetro a led e cascata.  
Stainless steel shower head 580x480mm two functions with led perimeter and waterfall.



IP54

**VB58482**

Cromo | Chrome 144 LED

580x480 mm

**4.300,00 €**



## CROMOTERAPIA IN



Soffione in acciaio inox 630x480mm con cromoterapia tre funzioni.  
Stainless steel shower head 630x480mm with chromotherapy three functions.



IP54

**CT09144**

Cromo | Chrome 144 LED

630x480 mm

**3.300,00 €**

# CROMOTERAPIA



## CROMOTERAPIA OUT

Soffione cromoterapia in acciaio inox d.500mm una funzione con perimetro a led.  
Stainless steel head shower d.500mm one function with led perimeter.



IP54

**VBT5001**

Cromo | Chrome 144 LED

Ø500 mm

**4.500,00 €**



## CROMOTERAPIA OUT

Soffione cromoterapia in acciaio inox d.500mm due funzioni con perimetro a led e cascata.  
Stainless steel head shower d.500mm two functions with led perimeter and waterfall.



IP54

**VBT5002**

Cromo | Chrome 144 LED

Ø500 mm

**4.900,00 €**



## CROMOTERAPIA OUT

Soffione cromoterapia in acciaio inox d.500mm tre funzioni con perimetro a led, cascata e idrogetto.  
Stainless steel head shower d.500mm three functions with led perimeter, waterfall and pump-jet.



IP54

**VBT5003**

Cromo | Chrome 144 LED

Ø500 mm

**4.980,00 €**

# CROMOTERAPIA



## ATEN CROMOTERAPIA

Soffione cromoterapia in acciaio inox a parete con led centrale.  
Stainless steel wall shower head with central led.



IP54

**VB04858CT**

Cromo | Chrome 144 LED

380x556x280 mm

**1.670,00 €**

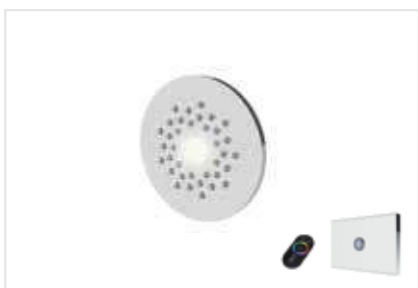

## SOFFIONCINO CROMOTERAPIA INCASSO A PARETE

Soffioncino cromoterapia tondo in acciaio inox d.120mm incasso a parete.  
Stainless steel round shower head d.120mm built-in with chromotherapy.



IP54

**VBT120**

Cromo | Chrome 144 LED

Ø120 mm

**730,00 €**

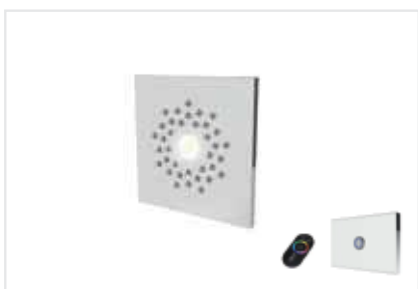

## SOFFIONCINO CROMOTERAPIA INCASSO A PARETE

Soffioncino cromoterapia quadro in acciaio inox 120x120mm incasso a parete.  
Stainless steel square head shower 120x120mm built-in with chromotherapy.



IP54

**VBQ120**

Cromo | Chrome 144 LED

120x120 mm

**730,00 €**



## COMANDO

Comando ad incasso per accensione e spegnimento soffioni dotati di cromoterapia.  
Recessed control for switching on and off shower heads equipped with chromotherapy.

**CTINC** Cromo | Chrome **300,00 €**



## TELECOMANDO

Telecomando di controllo per soffioni dotati di cromoterapia.  
Remote control for shower heads equipped with chromotherapy.

**CTTEL** **240,00 €**

# CASCADE



## CASCADE IN

Cascata a incasso.  
*Built-in waterfall.*



IP54



**C47244**

Cromo | Chrome 144 LED

346x80 mm

**430,00 €**



## CASCADE OUT

Cascata a parete esterna.  
*External waterfall.*



IP54



**C37244**

Cromo | Chrome 144 LED

346x80 mm

**458,00 €**



AZZURRA con OMEGA e doccia ottone

Immagine a titolo esemplificativo \_ Image as an example

# AZZURRA INOX

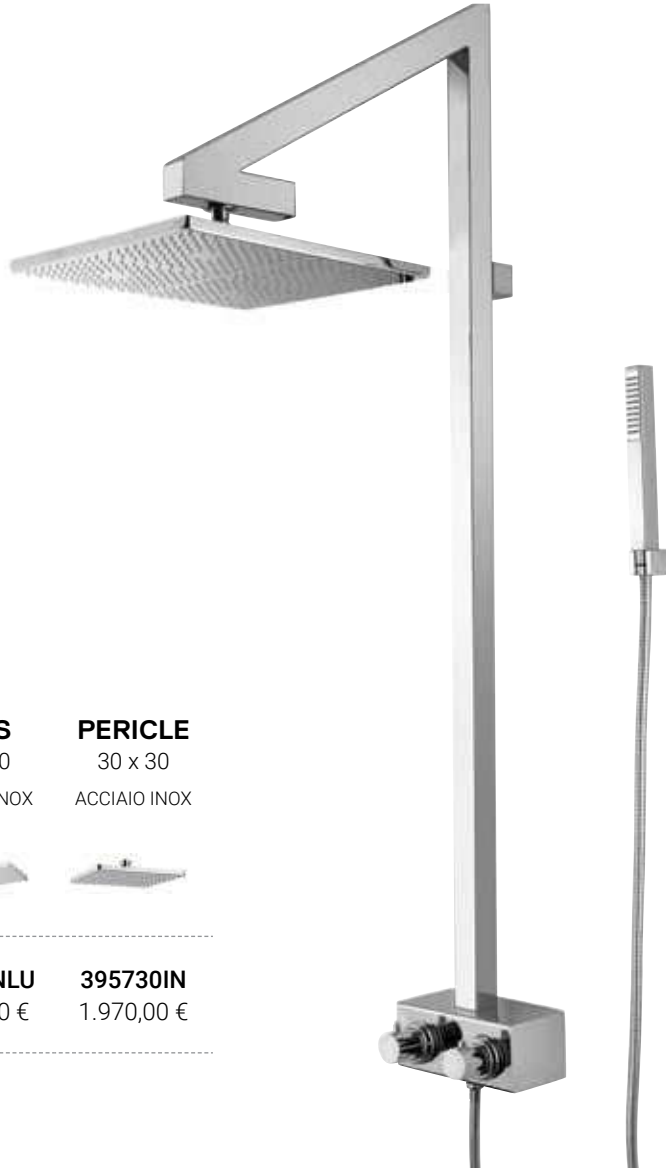
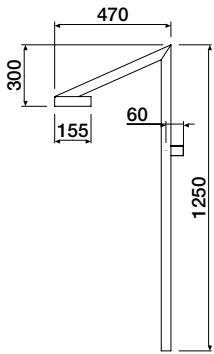

<b>OMEGA</b>	<b>EROS</b>	<b>PERICLE</b>
40 x 40	40 x 20	30 x 30
ACCIAIO INOX	ACCIAIO INOX	ACCIAIO INOX



<b>39500INLU</b>	<b>39600INLU</b>	<b>395730IN</b>
2.308,00 €	1.950,00 €	1.970,00 €

**39500INSA**  
2.220,00 €

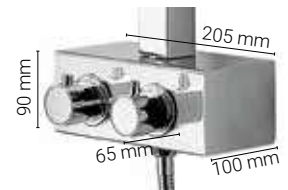

Termostatico in acciaio inox.  
Interasse 150 mm.  
Stainless steel thermostatic mixer.  
Interaxis distance 150 mm.

Colonna doccia interamente in acciaio inox 40 mm. Altezza totale 125 cm. Completa di termostatico e deviatore. Soffione doccia in acciaio inox con snodo. Doccia monogetto anticalcare MINI QUADRA. Flessibile in acciaio inox doppia aggraffatura con attacco conico girevole, lunghezza 150 cm. Disponibile nelle versioni lucido o satinato.

*Stainless steel shower column 40 mm total height 125 cm. Complete with thermostatic and diverter. Stainless steel head shower with swivel ball. Antiscale single jet shower MINI QUADRA. Double interlock stainless steel flexible hose swivel conical connection, length 150 cm. Available: polished or brushed finishing.*





ONDA con PENELOPE e doccia ottone

Immagine a titolo esemplificativo \_ Image as an example

# ONDA INOX

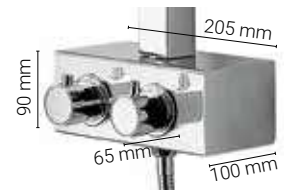
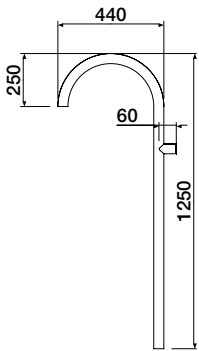

Termostatico in acciaio inox.  
Interasse 150 mm.  
Stainless steel thermostatic mixer.  
Interaxis distance 150 mm.

## OMEGA

40 x 40  
ACCIAIO INOX



**39900INLU**  
2.183,00 €

**39900INSA**  
2.298,00 €

## EROS

40 x 20  
ACCIAIO INOX



**39400INLU**  
1.868,00 €

## PENELOPE

Ø 30  
ACCIAIO INOX



**39830INLU**  
1.615,00 €

Colonna doccia interamente in acciaio inox Ø 40 mm. Altezza totale 125 cm. Completa di termostatico e deviatore. Soffione doccia in acciaio inox con snodo. Doccia monogetto anticalcare MINI TONDA. Supporto in ottone cromato Flessibile in acciaio inox doppia aggiratura con attacco conico girevole, lunghezza 150 cm. Disponibile nelle versioni lucido o satinato.

Stainless steel shower column Ø 40 mm total height 125 cm. Complete with thermostatic and diverter. Stainless steel head shower with swivel ball. Antiscale single jet shower MINI TONDA. Wall paper support in chromed brushed. Double interlock stainless steel flexible hose swivel conical connection, length 150 cm. Available: polished or brushed finishing.





# OUTDOOR

SEZ.		PAG.
○	AQUALAKE	116
○	RIVER T	118
□	RIVER Q	118
○	H2O	120
○	ONDA INOX	122
○	YACHT	124
□	AZZURRA INOX	126
○	OCEAN	128
○	TORRE MIX	130



Immagine a titolo esemplificativo \_ Image as an example

# AQUALAKE

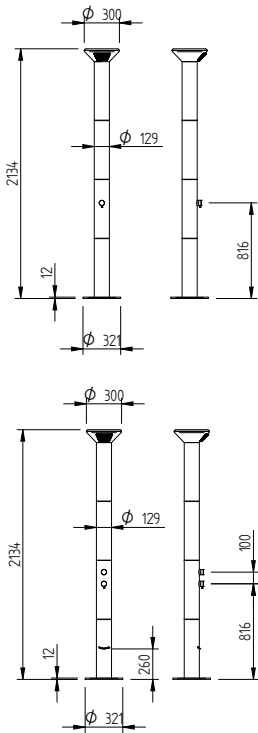

**cod. VB79903P**

colonna con getto piedi

cromo / chrome **7.200,00 €**

**cod. VB79903**

colonna senza getto piedi

cromo / chrome **6.900,00 €**



**cod. VB79903P**

**cod. VB79903**

Costruzione: Moduli portanti in Acciaio Inox AISI 316  
(A richiesta Acciaio Inox AISI 304)  
Peso: 17 kg a vuoto  
Ugelli: N°91 anticalcare in silicone alimentare trasparente  
Getto pioggia: Portata minima consigliata 15 l/min  
Lama d'acqua: Portata minima consigliata 15 l/min  
Dimensioni: 2135x130x300  
Presca acqua: 2 x 1/2 GAS Femmina

Construction: supporting structures in stainless steel  
AISI 316 (On request stainless steel AISI 304)  
Weight: 17 kg  
Nozzles: N°91 in transparent antiscala food grade silicone  
Rain jet: minimum suggested flow rate 15 l/min  
Water fountain: minimum suggested flow rate 15 l/min  
Dimensions: 2135x130x300  
Water supply: 2 x 1/2 female gas





Immagine a titolo esemplificativo \_ Image as an example

# RIVER T - RIVER Q

Tonda | Quadra

WELLNESS & OUTDOOR

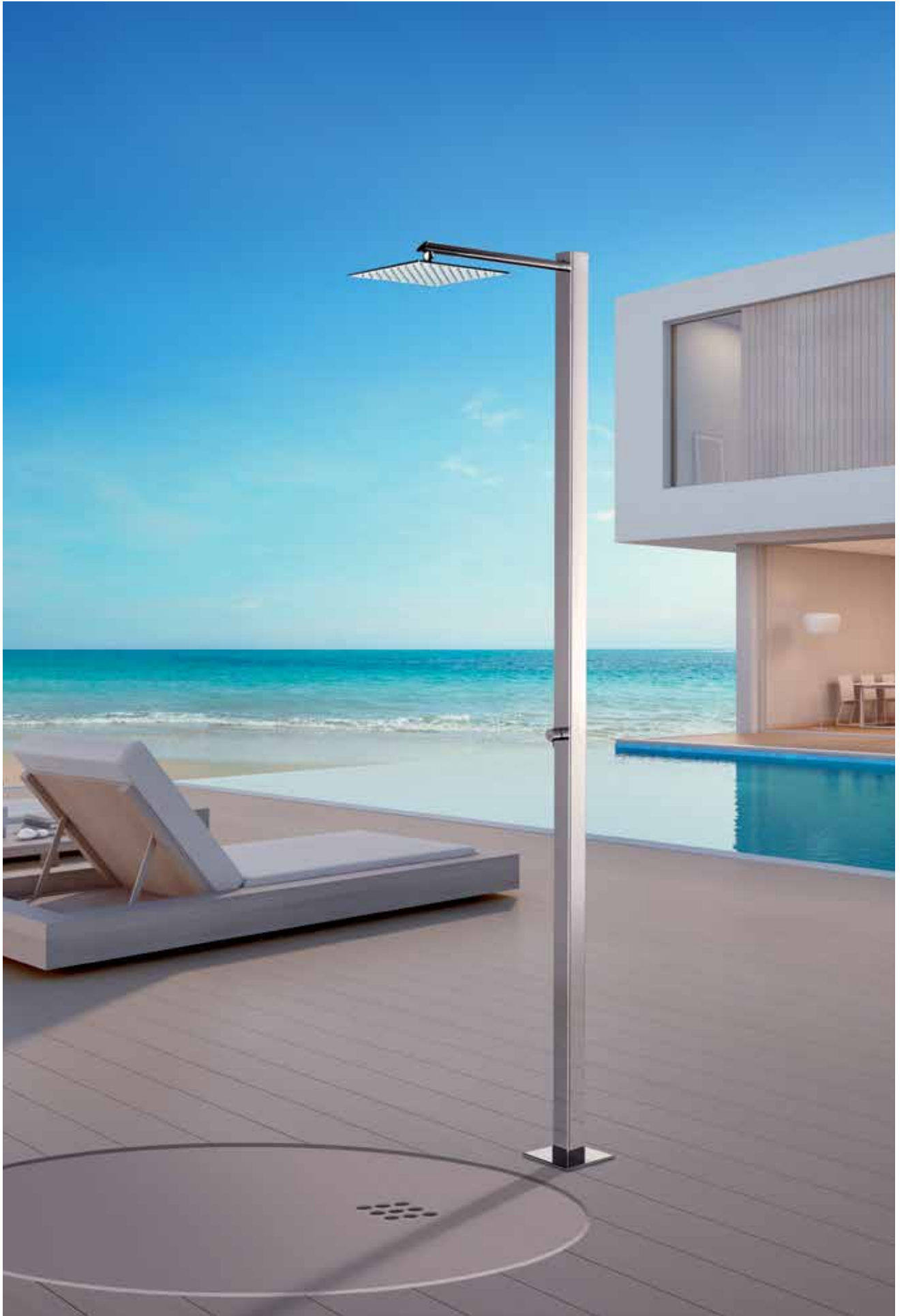
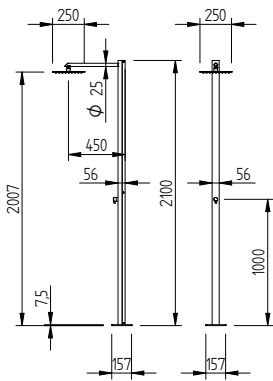

cod. **VB79904T**

colonna tonda

cromo / chrome **1.950,00 €**

cod. **VB79904Q**

colonna quadra

cromo / chrome **1.850,00 €**



cod. **VB79904T**

cod. **VB79904Q**

## Versioni disponibili con o senza doccia.

Costruzione: Acciaio Inox AISI 316  
(A richiesta Acciaio Inox AISI 304)  
Comando: Miscelatore manuale acqua calda / fredda  
Peso: 11 kg a vuoto  
Getto pioggia: Soffione colonna RIVER Q  
250x250mm / soffione colonna RIVER T Ø 250mm  
con n°81 ugelli in silicone alimentare  
anticalcare trasparente  
Portata: Portata minima consigliata 15l/min  
Dimensioni: 2100x157x157

## Available with or without handshower

Presca acqua: 2 x 1/2 GAS Femmina  
Construction: stainless steel AISI 316  
(On request stainless steel AISI 304)  
Lever: hot/cold water manual mixer faucet  
Weight: 11 kg  
Rain jet: Head shower RIVER Q 250x250mm / head  
shower RIVER T Ø 250 mm with n°81 nozzles in  
transparent antiscalc food grade silicone  
Flow rate: minimum suggested flow rate 15 l/min  
Dimensions: 2100x157x157  
Water supply: 2 x 1/2 female gas



Design ufficio tecnico Aquaviva  
Design by Aquaviva's technical office





Immagine a titolo esemplificativo \_ Image as an example

# H<sub>2</sub>O

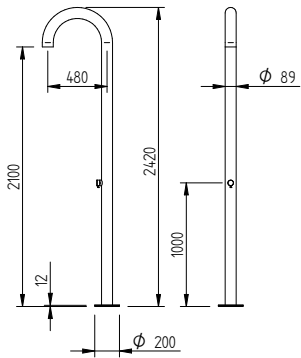
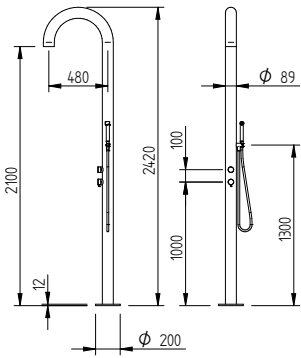

cod. **VB79905D**

colonna con doccia

acciaio / steel **5.750,00 €**

cod. **VB79905**

colonna senza doccia

acciaio / steel **5.150,00 €**

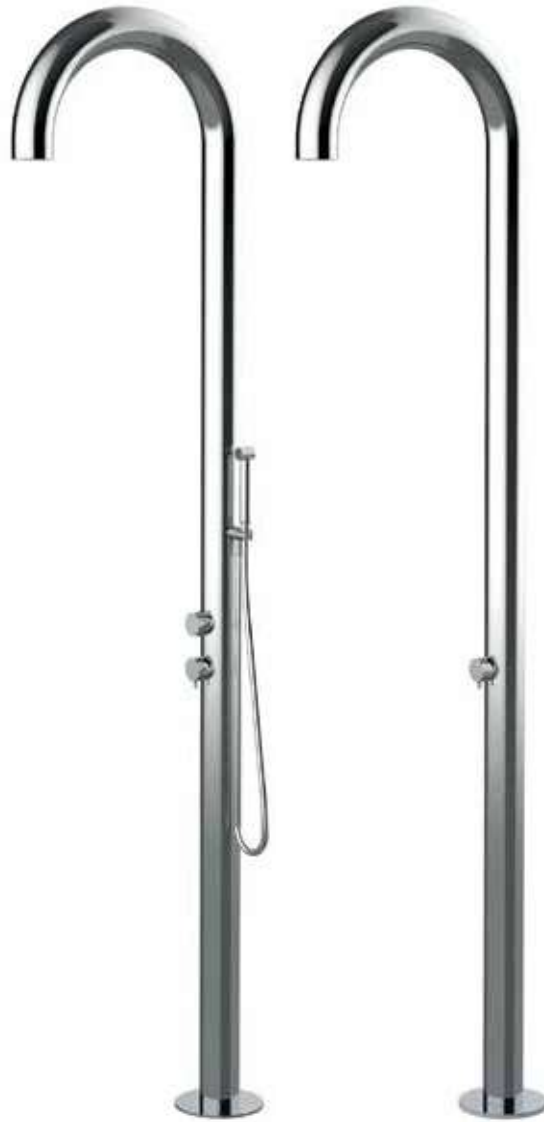

cod. VB79905D

cod. VB79905

Costruzione: Acciaio Inox AISI 316  
(A richiesta Acciaio Inox AISI 304)  
Comando: Miscelatore manuale  
acqua calda / fredda  
getto pioggia

Construction: stainless steel AISI 316  
(On request stainless steel AISI 304)  
Lever: hot/cold water manual mixer tap  
Rain jet





ONDA con PENELOPE e doccia ottone

Immagine a titolo esemplificativo \_ Image as an example

# ONDA INOX

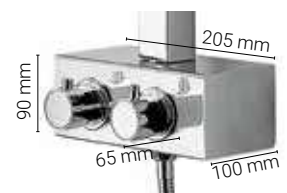
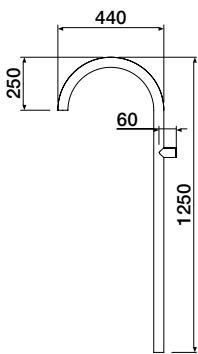

Termostatico in acciaio inox.  
Interasse 150 mm.  
Stainless steel thermostatic mixer.  
Interaxis distance 150 mm.

<b>OMEGA</b>	<b>EROS</b>	<b>PENELOPE</b>
40 x 40	40 x 20	30 Ø
ACCIAIO INOX	ACCIAIO INOX	ACCIAIO INOX



<b>39900INLU</b>	<b>39400INLU</b>	<b>39830INLU</b>
2.183,00 €	1.868,00 €	1.615,00 €

**39900INSA**  
2.298,00 €

Colonna doccia interamente in acciaio inox Ø 40 mm. Altezza totale 125 cm. Completa di termostatico e deviatore. Soffione doccia in acciaio inox con snodo. Doccia monogetto anticalcare MINI TONDA. Supporto in ottone cromato Flessibile in acciaio inox doppia aggraffatura con attacco conico girevole, lunghezza 150 cm. Disponibile nelle versioni lucido o satinato.

Stainless steel shower column Ø 40 mm total height 125 cm. Complete with thermostatic and diverter. Stainless steel head shower with swivel ball. Antiscale single jet shower MINI TONDA. Wall paper support in chromed brushed. Double interlock stainless steel flexible hose swivel conical connection, length 150 cm. Available: polished or brushed finishing.





Immagine a titolo esemplificativo \_ Image as an example

# YACHT

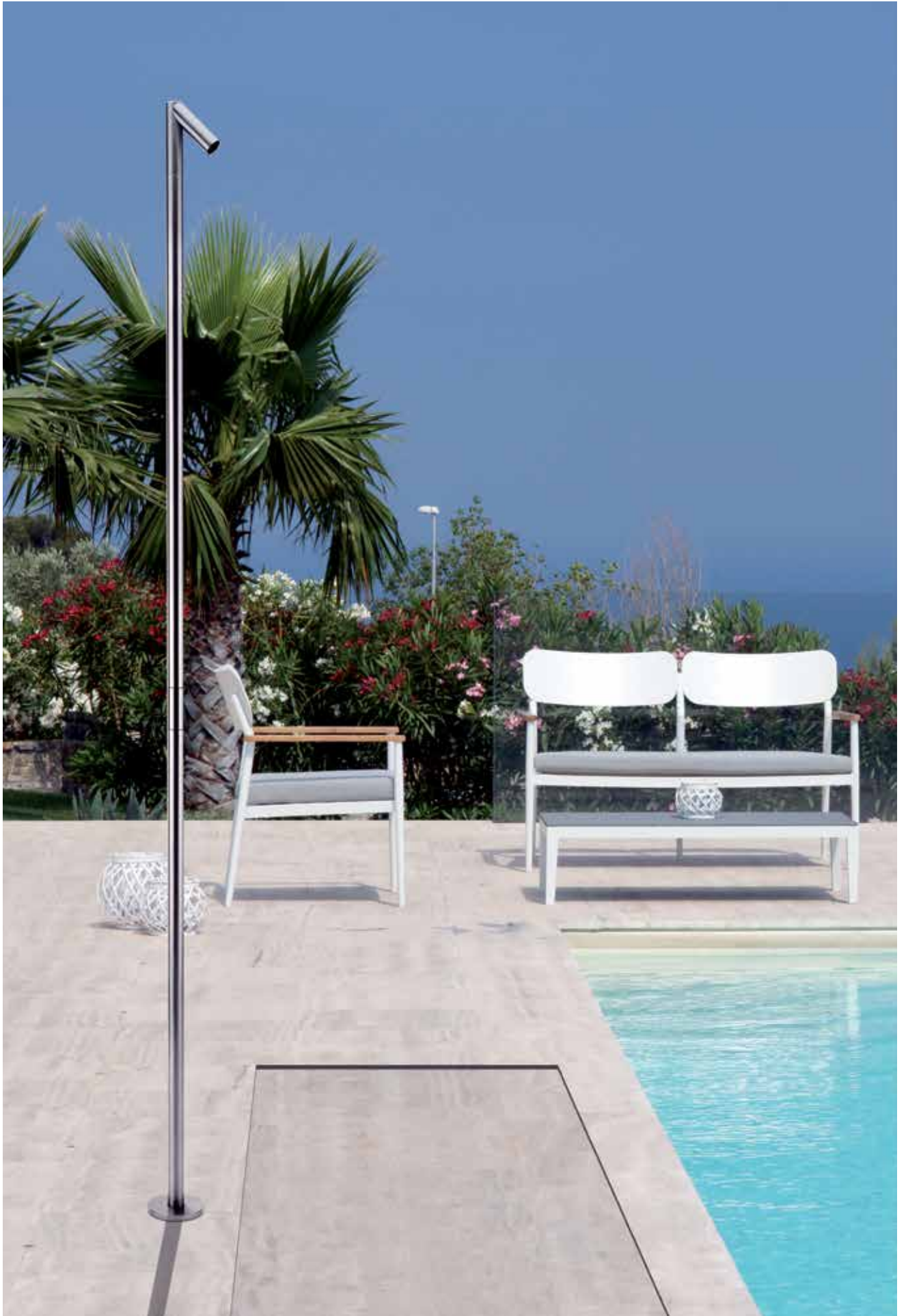

cod. **SMOTCR580**

colonna in ottone

cromo / chrome **2.130,00 €**

cod. **SMACC580**

colonna in acciaio

acciaio / steel **4.100,00 €**

su richiesta anche in acciaio navale



Disponibile per pavimentazioni in cemento e pavimentazioni flottanti.  
*Available for cement and floating floorings.*

Colonna doccia da esterno in ottone cromato o acciaio inox (su richiesta anche in acciaio navale) con attacco a pavimento rapido, per pavimentazioni in cemento o flottanti.

*Outdoor shower column in chromed brass or stainless steel (on request also in naval steel) with rapid floor connection, for cement or floating floorings*



Design ufficio tecnico Aquaviva  
Design by Aquaviva's technical office





AZZURRA con OMEGA e doccia ottone

Immagine a titolo esemplificativo \_ Image as an example

# AZZURRA INOX

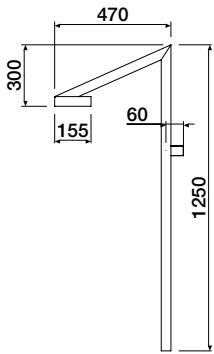

<b>OMEGA</b>	<b>EROS</b>	<b>PERICLE</b>
40 x 40	40 x 20	30 x 30
ACCIAIO INOX	ACCIAIO INOX	ACCIAIO INOX



<b>39500INLU</b>	<b>39600INLU</b>	<b>395730IN</b>
2.308,00 €	1.950,00 €	1.970,00 €

**39500INSA**  
2.220,00 €

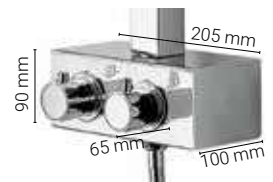

Termostatico in acciaio inox.  
Interasse 150 mm.  
Stainless steel thermostatic mixer.  
Interaxis distance 150 mm.

Colonna doccia interamente in acciaio inox 40 mm. Altezza totale 125 cm. Completa di termostatico e deviatore. Soffione doccia in acciaio inox con snodo. Doccia monogetto anticalcare MINI QUADRA. Flessibile in acciaio inox doppia aggraffatura con attacco conico girevole, lunghezza 150 cm. Disponibile nelle versioni lucido o satinato.

*Stainless steel shower column 40 mm total height 125 cm. Complete with thermostatic and diverter. Stainless steel head shower with swivel ball. Antiscale single jet shower MINI QUADRA. Double interlock stainless steel flexible hose swivel conical connection, length 150 cm. Available: polished or brushed finishing.*





Immagine a titolo esemplificativo \_ Image as an example

# OCEAN

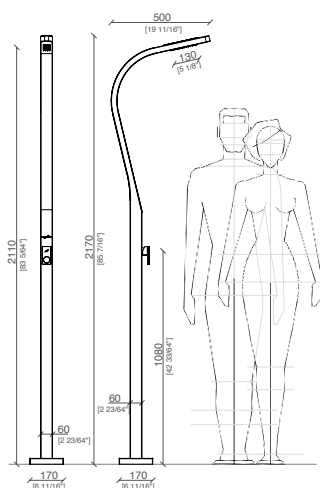

## cod. SI1030MISD

colonna con doccia,  
miscelatore con deviatore

acciaio / steel **9.350,00 €**

## cod. SI1030MIS

colonna senza doccia,  
con miscelatore

acciaio / steel **8.450,00 €**



cod. SI1030MISD

cod. SI1030MIS

Colonna doccia da esterno in acciaio inox AISI 316L, spessore 3mm, lucidatura manuale di qualità nautica, soffione incassato nel corpo, fondello di rivestimento del piede.

Stainless steel outdoor shower column AISI 316L, thickness 3mm, manual polishing, nautical level quality, shower head recessed into the shower body, bottom plate.





Immagine a titolo esemplificativo \_ Image as an example

# TORRE MIX

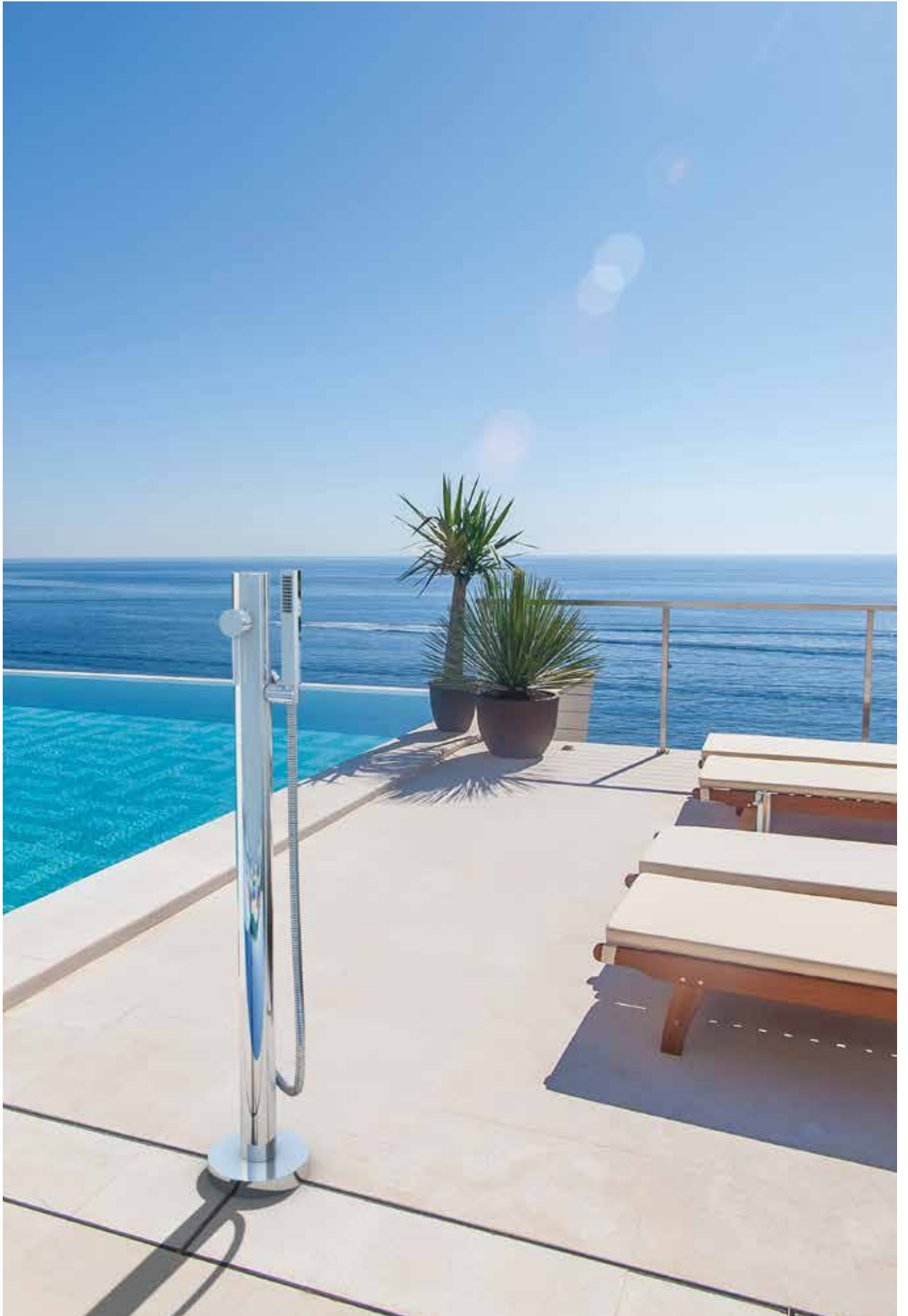
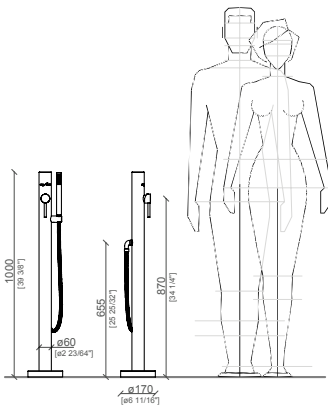

cod. **SI4023MIS**

colonnina da terra con  
miscelatore e doccia

acciaio / steel **2.550,00 €**



Colonna doccia da esterno in acciaio inox AISI 316L, lucidatura manuale di qualità nautica, doccia e fondello di rivestimento del piede.







*Stainless steel outdoor shower column AISI 316L, manual polishing, nautical level quality, shower head and bottom plate.*



# SOFFIONI E BRACCI DOCCIA

## SHOWER HEADS & ARMS

FINITURE SPECIALI SU RICHIESTA:  
SPECIAL FINISHING ON REQUEST:

-  **OR** Oro | Gold
-  **VO** Vecchio Ottone | Old Brass
-  **VR** Vecchio Rame | Old Copper
-  **NS** Nickel Spazzolato | Satin Nickel
-  **BS** Acciaio Spazzolato | Brushed Stainless Steel
-  **NE** Nero | Black
-  **BI** Bianco | White

Sugli articoli in finitura speciale si potrebbero presentare delle imperfezioni, dovute al tipo di lavorazione.  
*Please kindly note that on items in special finishing you may have imperfections due to the type of machining.*





SOFFIONI E BRACCI DOCCIA



# SOFFIONI E BRACCI DOCCIA

## SHOWER HEADS & ARMS

SEZ.	PAG.	SEZ.	PAG.
		<b>Soffioni da parete _</b>	
		<b>Wall shower head</b>	
		GOCCIA	136
□		ATEN 2	138
□		ATEN 1	140
□		FEEL	142
		<b>Soffioni da soffitto _</b>	
		<b>Ceiling shower heads</b>	
○		ON	144
□		TOP	144
		<b>Soffioni in ottone e inox _</b>	
		<b>Brass and inox shower heads</b>	
○		FRISBEE TONDO	146
□		FRISBEE QUADRO	146
○		DELTA	146
□		NETTUNO	146
□		OMEGA	147
□		EROS	147
○		NEW MERCURY	147
○		NEW MERCURY ANTICALCARE	147
○		PENELOPE	148
□		PERICLE	148
○		VEGA	150
○		MIZAR	150
○		VALVE INOX TONDO	152
□		VALVE INOX QUADRO	152
		<b>Soffioni in ABS _</b>	
		<b>ABS shower heads</b>	
○		SCIROCCO	153
○		SELENE	153
□		BORA	153
□		ECLIPSE	153
□		LYRAE	154
		<b>Soffioni ECO Monogetto _</b>	
		<b>Single jet ECO shower head</b>	
○		VIESTE	155
○		MARATEA	155
○		LIPARI	155
○		GARDA MONO	155
○		VALVE INOX TONDO	156
□		VALVE INOX QUADRO	156
		<b>Soffioni Multigetto _</b>	
		<b>Multi jet shower head</b>	
○		GARDA MULTI	157
○		SALÒ	157
		<b>Bracci doccia _</b>	
		<b>Shower arms for shower head</b>	
□		BRACCIO LUX CON DEVIATORE QUADRO	160
○		BRACCIO LUX CON DEVIATORE TONDO	160
○		LARGE	161
○		LINE	161
○		CLOSE	161
○		INOX MIDI	161
○		TONDO MINIMAL	162
○		LUX 21	162
○		LUX 18 OLD	163
○		LUX 18 MODE	163
○		SOFFITTO TONDO	163
○		WALL INOX	163
□		RETTANGOLARE	163
□		QUADRO MINIMAL	163
□		SOFFITTO QUADRO	164
○		STANDARD	164
○		PARADISO	165
○		ARCOBALENO	165
		KIT DOCCIA SOFFIONE + BRACCIO	168

## GOCCIA a parete

Design by Sarah - Ufficio tecnico Aquaviva / Design by Sarah - Aquaviva's technical office

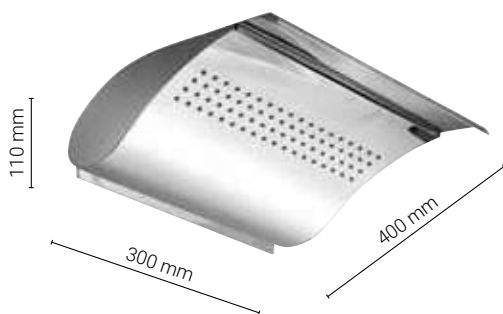

Soffione doccia da parete anticalcare in **acciaio INOX** con doppia funzione a pioggia o a cascata.

Antiscale **stainless steel** shower head for wall connection with waterfall and rainfall jets.



cod. **04271CR**

Soffione doccia.  
Shower head.

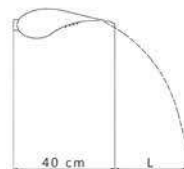

BAR	1	2	3
Lt/min	14,0	15,0	25,0
<b>Installazione / Installation H 200 cm</b>			
L	60 cm	70 cm	75 cm



**04271CR**

Cromo | Chrome

2.420,00 €



cod. **04771CRKRUT**

Kit doccia con rubinetto **termostatico** ad incasso.  
Shower kit with built-in **thermostatic** mixer

cod. **04771CRKRUM**

Kit doccia con **monocomando** ad incasso.  
Shower kit with built-in **single-lever mixer**.

Su richiesta fornitura incasso doccia 2 o 3 vie  
On request 2/3 way built-in shower supply.



**04771CRKRUT**  
**04771CRKRUM**

Cromo | Chrome  
Cromo | Chrome

3.300,00 €  
2.850,00 €

## ATEN 2 a parete



cod. 04859MINKRUM

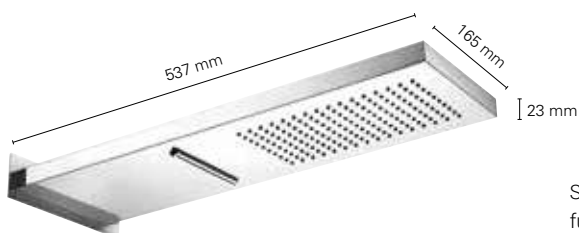

Soffione doccia ATEN anticalcare in **acciaio INOX** a muro con doppia funzione a pioggia o a cascata. Misure 537x165x23 mm.

**Stainless steel** shower head 537x165x23 mm with rainfall and waterfall jets.



spessore \_ thickness 23 mm



cod. **04858CRMIN**

Soffione doccia 2 getti.  
*Shower head.*



**04858CRMIN**

Cromo | Chrome

**810,00 €**



spessore \_ thickness 23 mm



cod. **04859MINKRUT**

Kit doccia con rubinetto **termostatico** ad incasso.  
*Shower kit with built-in **thermostatic** mixer*



cod. **04859MINKRUM**

Kit doccia con **monocomando** ad incasso.  
*Shower kit with built-in **single-lever mixer**.*

**Su richiesta fornitura incasso doccia 2 o 3 vie**  
***On request 2/3 way built-in shower supply.***

**04859MINKRUT**

Cromo | Chrome

**1.600,00 €**

**04859MINKRUM**

Cromo | Chrome

**1.250,00 €**

## ATEN 1 a parete



cod. 04850MINKRUM

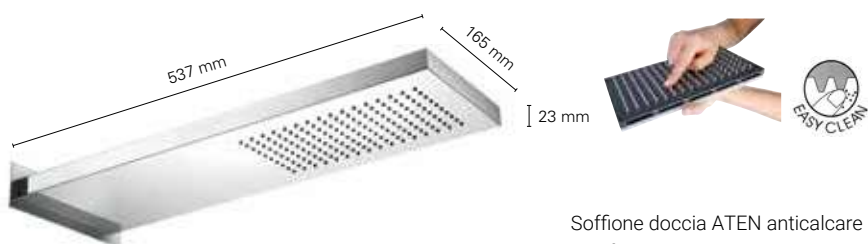

Soffione doccia ATEN anticalcare in **acciaio INOX** a muro con funzione a pioggia. Misure 537x165x23 mm.  
**Stainless steel** shower head 537x165x23mm with rainfall jets.



spessore \_ thickness 35 mm

cod. **04850CRMIN**

Soffione doccia monogetto.  
Shower head.



**04850CRMIN**

Cromo | Chrome

**725,00 €**



spessore \_ thickness 35 mm

cod. **04850MINKRUT**

Kit doccia con rubinetto **termostatico** ad incasso.  
Shower kit with built-in **thermostatic** mixer



cod. **04850MINKRUM**

Kit doccia con **monocomando** ad incasso.  
Shower kit with built-in **single-lever mixer**.

**Su richiesta fornitura incasso doccia 2 o 3 vie**  
**On request 2/3 way built-in shower supply.**



**04850MINKRUT**

Cromo | Chrome

**1.500,00 €**

**04850MINKRUM**

Cromo | Chrome

**1.170,00 €**

## FEEL a parete



cod. 04855CRKRUT

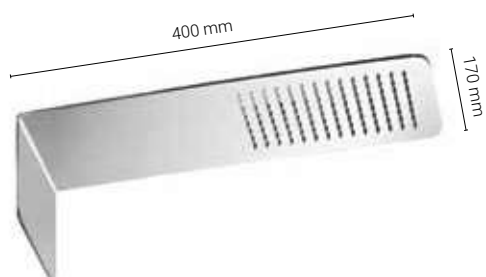

Soffione doccia FEEL in acciaio ultrapiatto **INOX super mirror** misure 400x170x4 mm. Attacco superiore.

**Ultraflat stainless steel** shower head 400x170x4 mm with rainfall jet.



spessore \_ thickness 4 mm

cod. **04855CR**

Soffione doccia.  
Shower head.



**04855CR**

Cromo | Chrome

530,00 €



spessore \_ thickness 4 mm

cod. **04855CRKRUT**

Kit doccia con rubinetto **termostatico** ad incasso.  
Shower kit with built-in **thermostatic** mixer



cod. **04855CRKRUM**

Kit doccia con **monocomando** ad incasso.  
Shower kit with built-in **single-lever mixer**.

Su richiesta fornitura incasso doccia 2 o 3 vie  
On request 2/3 way built-in shower supply.



**04855CRKRUT**

Cromo | Chrome

1.320,00 €

**04855CRKRUM**

Cromo | Chrome

960,00 €

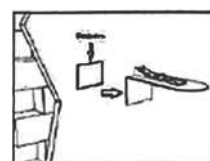
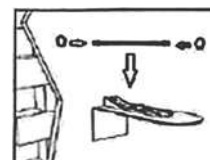

Si installa facilmente con l'inserimento di un solo raccordo da 1/2" femmina senza fori o tasselli a muro.

*It is easily installed by inserting only one 1/2" female fitting without holes or wall plugs.*

**ON - TOP**  
**incasso a soffitto**



cod. 05331IN30KRUT 1.170,00 € - 05331IN30KRUM 855,00 €

soffione **ON**

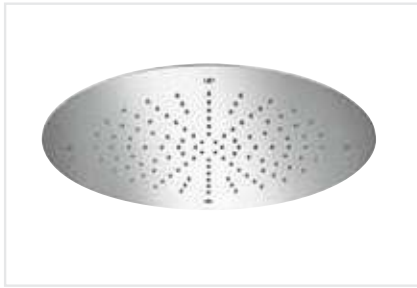

## ON



Soffione doccia in **acciaio INOX super mirror** con ugelli anticalcare. Kit di fissaggio a soffitto.  
**Super mirror stainless steel** ceiling shower head with antiscald nozzles and fixation kit.



<b>05331IN30</b>	Cromo   Chrome	Ø300 mm	<b>690,00 €</b>
<b>05331IN40</b>	Cromo   Chrome	Ø400 mm	<b>950,00 €</b>
<b>05331IN50</b>	Cromo   Chrome	Ø500 mm	<b>1.050,00 €</b>

\* Misure speciali su richiesta \_ Special measures on request



## TOP



Soffione doccia in **acciaio INOX super mirror** con ugelli anticalcare. Kit di fissaggio a soffitto.  
**Super mirror stainless steel** ceiling shower head with antiscald nozzles and fixation kit.



<b>05341IN30</b>	Cromo   Chrome	300x300 mm	<b>730,00 €</b>
<b>05341IN40</b>	Cromo   Chrome	400x400 mm	<b>1.070,00 €</b>
<b>05341IN50</b>	Cromo   Chrome	500x500 mm	<b>1.160,00 €</b>
<b>05341IN54</b>	Cromo   Chrome	500x400 mm	<b>1.200,00 €</b>

\* Misure speciali su richiesta \_ Special measures on request





spessore \_ thickness 13 mm



## FRISBEE TONDO

Soffione doccia tondo ispezionabile in **ottone cromato**. Attacco 1/2" completo di snodo.  
*Chromed **brass** inspectionable round shower head. Connection 1/2" with swivel ball.*

<b>05500CR20</b>	Cromo   Chrome	Ø 200 mm	<b>146,00 €</b>
<b>05500OR20</b>	Oro   Gold	Ø 200 mm	<b>215,00 €</b>
<b>05500VO20</b>	Vecchio Ottone   Old Brass	Ø 200 mm	<b>215,00 €</b>



spessore \_ thickness 13 mm



## FRISBEE QUADRO

Soffione doccia quadro ispezionabile in **ottone cromato**. Attacco 1/2" completo di snodo.  
*Chromed **brass** inspectionable square shower head. Connection 1/2" with swivel ball.*

<b>05550CR20</b>	Cromo   Chrome	Ø 200 mm	<b>220,00 €</b>
<b>05550OR20</b>	Oro   Gold	Ø 200 mm	<b>306,00 €</b>
<b>05550VO20</b>	Vecchio Ottone   Old Brass	Ø 200 mm	<b>306,00 €</b>



spessore \_ thickness 15 mm



## DELTA

Soffione doccia tondo in **acciaio INOX** lucido/cromato con ugelli in silicone anticalcare.  
 Attacco 1/2" completo di snodo.  
*Polished/chromed **stainless steel** round shower head with antiscald silicone nozzles.  
 Connection 1/2" with swivel ball.*

<b>05350IN20</b>	Acciaio lucido   Polished stainless steel	Ø 200 mm	<b>224,00 €</b>
<b>05350IN20CR</b>	Acciaio cromato   Chromed stainless steel	Ø 200 mm	<b>234,00 €</b>
<b>05350IN20SPAZ</b>	Acciaio Spazzolato   Brushed Stainless Steel	Ø 200 mm	<b>243,00 €</b>



spessore \_ thickness 15 mm



## NETTUNO

Soffione doccia quadro in **acciaio inox** lucido/cromato, con ugelli in silicone anticalcare.  
 Attacco 1/2" completo di snodo.  
*Polished/chromed **stainless steel** square shower head with antiscald silicone nozzles.  
 Connection 1/2" with swivel ball.*



OR



VO



<b>05700IN20</b>	Acciaio lucido   Polished stainless steel	200x200 mm	<b>285,00 €</b>
<b>05700IN20CR</b>	Acciaio cromato   Chromed stainless steel	200x200 mm	<b>305,00 €</b>
<b>05700IN20SPAZ</b>	Acciaio Spazzolato   Brushed Stainless Steel	200x200 mm	<b>305,00 €</b>

\* Finiture speciali su richiesta \_ Special finishing on request



spessore \_ thickness 15 mm



## OMEGA

Soffione doccia quadro in **acciaio inox** lucido/satinato, con ugelli in silicone anticalcare.  
Attacco 1/2" completo di snodo.  
*Polish/mat stainless steel square shower head, with antiscaling silicone nozzles.*  
*Connection 1/2" with swivel ball.*



<b>05680IN40LU</b>	Acciaio lucido   Polished stainless steel	400x400 mm	<b>930,00 €</b>
<b>05680IN40SPAZ</b>	Acciaio Spazzolato   Brushed Stainless Steel	400x400 mm	<b>940,00 €</b>

\* Finiture speciali su richiesta \_ Special finishing on request



spessore \_ thickness 15 mm



## EROS

Soffione doccia quadro in **acciaio inox** lucido/cromato, con ugelli in silicone anticalcare.  
Attacco 1/2" completo di snodo.  
*Polished/chromed stainless steel square shower head with antiscaling silicone nozzles.*  
*Connection 1/2" with swivel ball.*



<b>05760IN40</b>	Acciaio lucido   Polished stainless steel	400x200 mm	<b>580,00 €</b>
<b>05760IN40CR</b>	Acciaio cromato   Chromed stainless steel	400x200 mm	<b>610,00 €</b>
<b>05760IN40SPAZ</b>	Acciaio Spazzolato   Brushed Stainless Steel	400x200 mm	<b>610,00 €</b>

\* Finiture speciali su richiesta \_ Special finishing on request



spessore \_ thickness 80 mm



## NEW MERCURY

Soffione doccia tondo in **ottone** cromato. Finitura con bugne. Attacco 1/2" completo di snodo.  
*Chromed brass round shower head. Bulging finishing. Connection 1/2" with swivel ball.*



OR



VO

Filtro ispezionabile per pulizia calcare  
*Demontable filter for cleaning*



<b>05160CR15</b>	Cromo   Chrome	Ø 150 mm	<b>150,00 €</b>
<b>05160CR20</b>	Cromo   Chrome	Ø 200 mm	<b>170,00 €</b>
<b>05160OR20</b>	Oro   Gold	Ø 200 mm	<b>245,00 €</b>
<b>05160VO20</b>	Vecchio Ottone   Old Brass	Ø 200 mm	<b>245,00 €</b>
<b>05160CR30</b>	Cromo   Chrome	Ø 300 mm	<b>322,00 €</b>

\* Finiture speciali su richiesta \_ Special finishing on request



spessore \_ thickness 100 mm



## NEW MERCURY ANTICALCARE

Soffione doccia tondo in **ottone** cromato, con ugelli in silicone anticalcare.  
Attacco 1/2" completo di snodo.  
*Chromed brass round shower head with antiscaling silicone nozzles.*  
*Connection 1/2" with swivel ball.*



OR



VO

Filtro ispezionabile per pulizia calcare  
*Demontable filter for cleaning*



<b>05160CR15AN</b>	Cromo   Chrome	Ø 150 mm	<b>220,00 €</b>
<b>05160CR20AN</b>	Cromo   Chrome	Ø 200 mm	<b>248,00 €</b>
<b>05160VO20AN</b>	Vecchio Ottone   Old Brass	Ø 200 mm	<b>348,00 €</b>
<b>05160OR20AN</b>	Oro   Gold	Ø 200 mm	<b>348,00 €</b>
<b>05160CR30AN</b>	Cromo   Chrome	Ø 300 mm	<b>450,00 €</b>

\* Finiture speciali su richiesta \_ Special finishing on request

## PENELOPE - PERICLE



cod. 05330I25KRUT 1.015,00 € - 05330I25KRUM 735,00 €

soffione PENELOPE



spessore \_ thickness 7 mm



## PENELOPE

Soffione **acciaio inox super mirror** 18/10, spessore 7 mm, con ugelli in silicone anticalcare ispezionabile, ghiera in ottone cromato. Attacco da 1/2" completo di snodo.

**Super mirror stainless steel** 18/10 shower head, thickness 7 mm with antiscaling silicone nozzles. Connection 1/2" with swivel ball.

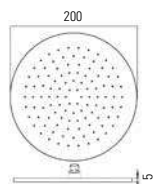

Disponibili finiture PVD | PVD finishes available

<b>053301200</b>	Cromo   Chrome	Ø200 mm	<b>180,00 €</b>
<b>053301250</b>	Cromo   Chrome	Ø250 mm	<b>225,00 €</b>
<b>053301300</b>	Cromo   Chrome	Ø300 mm	<b>280,00 €</b>
<b>053301400</b>	Cromo   Chrome	Ø400 mm	<b>425,00 €</b>

\* Misure speciali su richiesta \_ Special measures on request | Finiture speciali su richiesta \_ Special finishing on request



spessore \_ thickness 7 mm



## PERICLE

Soffione **acciaio inox super mirror** 18/10, spessore 7 mm, con ugelli in silicone anticalcare ispezionabile, ghiera in ottone cromato. Attacco da 1/2" completo di snodo.

**Super mirror stainless steel** 18/10 shower head, thickness 7 mm with antiscaling silicone nozzles. Connection 1/2" with swivel ball.

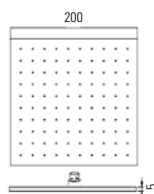

Disponibili finiture PVD | PVD finishes available

<b>057301200</b>	Cromo   Chrome	200x200 mm	<b>190,00 €</b>
<b>057301250</b>	Cromo   Chrome	250x250 mm	<b>255,00 €</b>
<b>057301300</b>	Cromo   Chrome	300x300 mm	<b>310,00 €</b>
<b>057301400</b>	Cromo   Chrome	400x400 mm	<b>450,00 €</b>
<b>0573013525</b>	Cromo   Chrome	350x250 mm	<b>330,00 €</b>

\* Misure speciali su richiesta \_ Special measures on request | Finiture speciali su richiesta \_ Special finishing on request

## VEGA - MIZAR



soffione VEGA



spessore \_ thickness 13 mm

## VEGA

Soffione doccia tondo in **acciaio inox** cromato con ugelli in silicone anticalcare ispezionabile. Attacco 1/2" completo di snodo.

**Stainless steel** round shower head with antiscald silicone nozzles. Connection 1/2" with swivel ball.

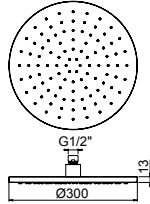

Disponibili finiture PVD | PVD finishes available

<b>052301200</b>	Cromo   Chrome	Ø200 mm	<b>210,00 €</b>
<b>052301250</b>	Cromo   Chrome	Ø250 mm	<b>325,00 €</b>
<b>052301300</b>	Cromo   Chrome	Ø300 mm	<b>340,00 €</b>
<b>052301400</b>	Cromo   Chrome	Ø400 mm	<b>480,00 €</b>



\* Misure speciali su richiesta \_ Special measures on request | Finiture speciali su richiesta \_ Special finishing on request



spessore \_ thickness 13 mm

## MIZAR

Soffione doccia quadro in **acciaio inox** cromato con ugelli in silicone anticalcare ispezionabile. Attacco 1/2" completo di snodo.

**Stainless steel** square shower head with antiscald silicone nozzles. Connection 1/2" with swivel ball.

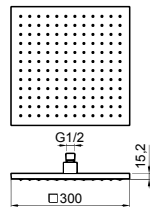

Disponibili finiture PVD | PVD finishes available

<b>052501200</b>	Cromo   Chrome	200x200 mm	<b>235,00 €</b>
<b>052501250</b>	Cromo   Chrome	250x250 mm	<b>350,00 €</b>
<b>052501300</b>	Cromo   Chrome	300x300 mm	<b>400,00 €</b>
<b>052501400</b>	Cromo   Chrome	400x400 mm	<b>520,00 €</b>



\* Misure speciali su richiesta \_ Special measures on request | Finiture speciali su richiesta \_ Special finishing on request



spessore \_ thickness 2 mm



## VALVE INOX TONDO

Soffione **acciaio inox 18/10 super mirror CON VALVOLA DI SICUREZZA.**

Spessore 2 mm. Ugelli in silicone anticalcare. Pulizia ugelli con il passaggio della mano.

Attacco da 1/2" completo di snodo.

**Super mirror stainless steel 18/10 shower head WITH SAFETY VALVE, thickness 2 mm.**

Antiscale silicone nozzles cleanable passing the hand over. Connection 1/2" with swivel ball.



<b>05720110V</b>	Cromo   Chrome	Ø 100 mm	<b>54,00 €</b>
<b>05720120V</b>	Cromo   Chrome	Ø 200 mm	<b>77,00 €</b>
<b>05720125V</b>	Cromo   Chrome	Ø 250 mm	<b>108,00 €</b>
<b>05720130V</b>	Cromo   Chrome	Ø 300 mm	<b>128,00 €</b>
<b>05720140V</b>	Cromo   Chrome	Ø 400 mm	<b>230,00 €</b>

\* Misure speciali su richiesta \_ Special measures on request



spessore \_ thickness 2 mm



## VALVE INOX QUADRO

Soffione **acciaio inox 18/10 super mirror CON VALVOLA DI SICUREZZA.**

Spessore 2 mm. Ugelli in silicone anticalcare. Pulizia ugelli con il passaggio della mano.

Attacco da 1/2" completo di snodo.

**Super mirror stainless steel 18/10 shower head WITH SAFETY VALVE, thickness 2 mm.**

Antiscale silicone nozzles cleanable passing the hand over. Connection 1/2" with swivel ball.



<b>05770110V</b>	Cromo   Chrome	100x100 mm	<b>64,00 €</b>
<b>05770120V</b>	Cromo   Chrome	200x200 mm	<b>81,00 €</b>
<b>05770125V</b>	Cromo   Chrome	250x250 mm	<b>115,00 €</b>
<b>05770130V</b>	Cromo   Chrome	300x300 mm	<b>140,00 €</b>
<b>05770140V</b>	Cromo   Chrome	400x400 mm	<b>240,00 €</b>

\* Misure speciali su richiesta \_ Special measures on request





spessore \_ thickness 15 mm

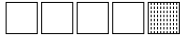

## SCIROCCO

Soffione doccia tondo in **ABS** cromato anticalcare. Attacco 1/2" completo di snodo.  
*Chromed ABS antiscale round shower head. Connection 1/2" with swivel ball.*



OR



VO



<b>05650CR</b>	Cromo   Chrome	Ø 200 mm	<b>110,00 €</b>
<b>05650OR</b>	Oro   Gold	Ø 200 mm	<b>160,00 €</b>
<b>05650VO</b>	Vecchio Ottone   Old Brass	Ø 200 mm	<b>160,00 €</b>

\* Finiture speciali su richiesta \_ *Special finishing on request*



spessore \_ thickness 13 mm

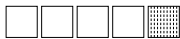

## SELENE

Soffione doccia tondo in **ABS** cromato anticalcare. Attacco 1/2" completo di snodo.  
*Chromed ABS antiscale round shower head. Connection 1/2" with swivel ball.*

<b>05620CR20</b>	Cromo   Chrome	Ø 200 mm	<b>110,00 €</b>
<b>05620CR25</b>	Cromo   Chrome	Ø 250 mm	<b>125,00 €</b>



spessore \_ thickness 15 mm



## BORA

Soffione doccia quadro in **ABS** cromato anticalcare. Attacco 1/2" completo di snodo.  
*Chromed ABS antiscale square shower head. Connection 1/2" with swivel ball.*

<b>05632CR</b>	Cromo   Chrome	200x200 mm	<b>120,00 €</b>
----------------	----------------	------------	-----------------

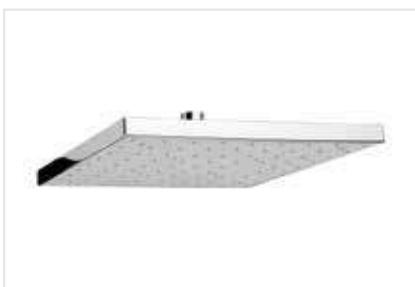

spessore \_ thickness 16 mm



## ECLIPSE

Soffione doccia quadro in **ABS** cromato anticalcare. Attacco 1/2" completo di snodo.  
*Chromed ABS antiscale square shower head. Connection 1/2" with swivel ball.*

<b>05670CR25</b>	Cromo   Chrome	250x250 mm	<b>170,00 €</b>
------------------	----------------	------------	-----------------



spessore \_ thickness 15 mm

## LYRAE

Soffione doccia rettangolare **240x360 mm** in **ABS** cromato anticalcare.

Attacco 1/2" completo di snodo.

*Chromed ABS antiscale rectangular shower head.*

*Connection 1/2" with swivel ball.*



**05640CR**

Cromo | Chrome

240x360 mm

**218,00 €**



### VIESTE

Soffione doccia monogetto in metallo cromato, completo di snodo.  
*Chromed metal single jet shower head with swivel ball.*



**04000CR**

Cromo | Chrome

Ø80 mm

**12,00 €**

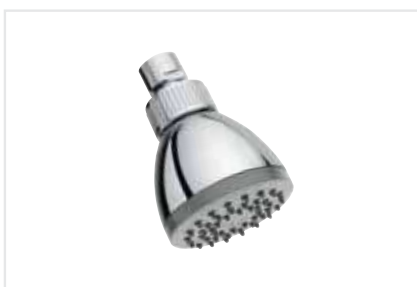

### MARATEA

Soffione doccia monogetto anticalcare in **ABS** cromato, completo di snodo.  
*Chromed ABS single jet antiscala shower head with swivel ball.*



**04020CR**

Cromo | Chrome

Ø80 mm

**9,90 €**

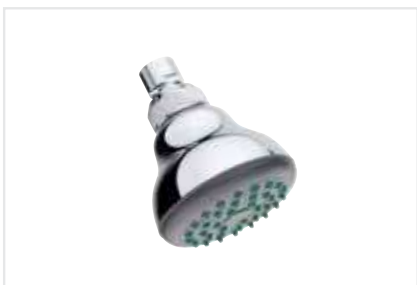

### LIPARI

Soffione doccia monogetto anticalcare in **ABS** cromato, completo di snodo.  
*Chromed ABS single jet antiscala shower head with swivel ball.*



**04030CR**

Cromo | Chrome

Ø80 mm

**16,00 €**



### GARDA MONO

Soffione doccia monogetto anticalcare in **ABS** cromato, completo di snodo.  
*Chromed ABS single jet antiscala shower head with swivel ball.*



BI NE



**04046CR80**

Cromo | Chrome

Ø80 mm

**19,00 €**

**04046CR130**

Cromo | Chrome

Ø130 mm

**54,00 €**

**04046BI80**

Bianco | White

Ø80 mm

**78,00 €**

**04046NE80**

Nero | Black

Ø80 mm

**78,00 €**



spessore \_ thickness 2 mm



## VALVE INOX TONDO

Soffione **acciaio inox 18/10 super mirror CON VALVOLA DI SICUREZZA.**

Spessore 2 mm. Ugelli in silicone anticalcare. Pulizia ugelli con il passaggio della mano.

Attacco da 1/2" completo di snodo.

**Super mirror stainless steel 18/10 shower head WITH SAFETY VALVE, thickness 2 mm.**

Antiscale silicone nozzles cleanable passing the hand over. Connection 1/2" with swivel ball.



BI NE

<b>05720I10V</b>	Cromo   Chrome	Ø100 mm	<b>54,00 €</b>
<b>05720BI10V</b>	Bianco   White	Ø100 mm	<b>102,00 €</b>
<b>05720NE10V</b>	Nero   Black	Ø100 mm	<b>102,00 €</b>



spessore \_ thickness 2 mm



## VALVE INOX QUADRO

Soffione **acciaio inox 18/10 super mirror CON VALVOLA DI SICUREZZA.**

Spessore 2 mm. Ugelli in silicone anticalcare. Pulizia ugelli con il passaggio della mano.

Attacco da 1/2" completo di snodo.

**Super mirror stainless steel 18/10 shower head WITH SAFETY VALVE, thickness 2 mm.**

Antiscale silicone nozzles cleanable passing the hand over. Connection 1/2" with swivel ball.



BI NE

<b>05770I10V</b>	Cromo   Chrome	100x100 mm	<b>64,00 €</b>
<b>05770BI10V</b>	Bianco   White	100x100 mm	<b>105,00 €</b>
<b>05770NE10V</b>	Nero   Black	100x100 mm	<b>105,00 €</b>





### GARDA MULTI

Soffione doccia multigetto anticalcare in **ABS** cromato, completo di snodo antiscippo.  
*Chromed ABS multi jet antiscald shower head with swivel ball.*



<b>04048CR80</b>	Cromo   Chrome	Ø80 mm	<b>39,00 €</b>
<b>04048CR130</b>	Cromo   Chrome	Ø130 mm	<b>71,00 €</b>
<b>04048BI80</b>	Bianco   White	Ø80 mm	<b>98,00 €</b>
<b>04048NE80</b>	Nero   Black	Ø80 mm	<b>98,00 €</b>



### SALÒ

Soffione doccia multigetto anticalcare in **ABS** cromato, completo di snodo.  
*Chromed ABS multi jet antiscald shower head with swivel ball.*



<b>04044CR</b>	Cromo   Chrome	Ø100 mm	<b>36,00 €</b>
----------------	----------------	---------	----------------

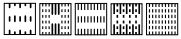

## FUNZIONAMENTO DEVIATORE - DIVERTER FUNCTIONING



K060B023261 538,00 €

Con deviatore alzato l'acqua verrà erogata dal soffione.  
 When the diverter is up, water comes out of the head shower.



Con deviatore abbassato l'acqua verrà erogata dal doccino.  
 When the diverter is down, water comes out of the hand shower.



La semplicità del funzionameto del nostro deviatore è caratterizzata dalla possibilità di azionarlo a qualsiasi altezza tirando il flessibile. Per il corretto funzionamento è necessaria una pressione minima di 1 bar. È possibile creare kit completi scegliendo, tra i soffioni, docce, saliscendi o supporti a muro presenti a catalogo "Aquaviva".

*Our diverter has a very easy functioning, as it can be activated at any height by pulling the hose. For correct operation is required the minimum pressure of 1 bar. Complete sets are possible using the shower heads, sliding bars or wall brackets shown in the "Aquaviva" catalogue.*

**1**

Svitare il nipples dal braccio e avvitarlo nel muro.  
*Remove the nipples from the arm and screw into the wall.*

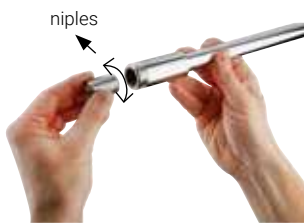
**2**

Avvitare il braccio (completo di rosone) al nipples fissato a muro.  
*Screw the arm (with the rosette) to the nipples fixed in the wall.*

**3**

Ruotare il rosone in senso orario fino alla posizione desiderata (filo muro).  
*Rotate the rosette clockwise for obtaining the desired position (flush with the wall).*

FACILITÀ DI MANUTENZIONE E PULIZIA GRAZIE AL COMPLETO SMONTAGGIO DELLE SINGOLE PARTI.  
*EASY MAINTENANCE AND CLEANING THANKS TO TOTAL DEMOUNTING OF EACH PART.*



### BRACCIO LUX CON DEVIATORE QUADRO

Braccio con attacco a muro da 1/2" in **ottone** cromato con **DEVIATORE** integrato.  
*Chromed brass shower arm with wall connection 1/2" integrated DIVERTER.*

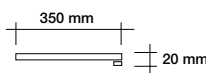
**06000CR35**

Cromo | Chrome

30x10 mm - L 350 mm

**220,00 €**\* Misure speciali su richiesta \_ *Special measures on request*

### BRACCIO LUX CON DEVIATORE TONDO

Braccio con attacco a muro da 1/2" in **ottone** cromato con **DEVIATORE** integrato.  
*Chromed brass shower arm with wall connection 1/2" integrated DIVERTER.*

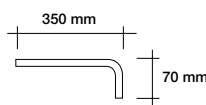
**05950CR35**

Cromo | Chrome

Ø21 mm - L 350 mm

**170,00 €**\* Misure speciali su richiesta \_ *Special measures on request*



### LARGE

Braccio con attacco a muro da 1/2" Ø 26 mm in **ottone cromato**.  
Chromed **brass** shower arm Ø 26 mm with wall connection 1/2".

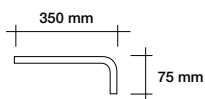

**05926CR35**

Cromo | Chrome

Ø26 mm - L 350 mm

**105,00 €**

\* Misure speciali su richiesta \_ *Special measures on request*



### LINE

Braccio con attacco a muro da 1/2" Ø 24 mm in **ottone cromato**.  
Chromed **brass** shower arm Ø 24 mm with wall connection 1/2".

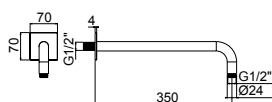

**05925CR35**

Cromo | Chrome

Ø24 mm - L 350 mm

**126,00 €**

\* Misure speciali su richiesta \_ *Special measures on request*



### CLOSE

Braccio con attacco a muro da 1/2" Ø 24 mm in **ottone cromato**.  
Chromed **brass** shower arm Ø 24 mm with wall connection 1/2".

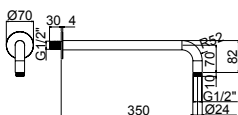

**05921CR35**

Cromo | Chrome

Ø24 mm - L 350 mm

**126,00 €**

\* Misure speciali su richiesta \_ *Special measures on request*



### INOX MIDI

Braccio con attacco a muro da 1/2" in **acciaio inox** Ø 22 mm spessore 1 mm.  
**Stainless steel** shower arm Ø 22 mm, thickness 1 mm with wall connection 1/2".

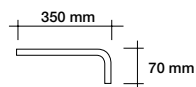

**05930IN35MIDI**

Cromo | Chrome

Ø22 mm - L 350 mm

**61,00 €**

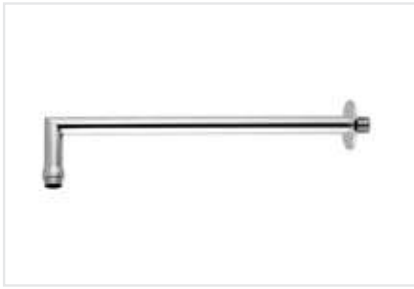

### TONDO MINIMAL

Braccio con attacco a muro da 1/2" in **ottone** cromato Ø 20 mm. Con rosone regolabile.  
Chromed **brass** shower arm Ø 20 mm with wall connection 1/2" and adjustable rosette.

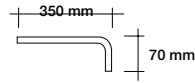

**05940CR35** Cromo | Chrome Ø20 mm - L 350 mm **82,00 €**

\* Misure speciali su richiesta \_ *Special measures on request*



### LUX 21

Braccio con attacco a muro da 1/2" in **ottone** cromato Ø 21 mm. Con rosone regolabile.  
Chromed **brass** shower arm Ø 21 mm with wall connection 1/2" and adjustable rosette.

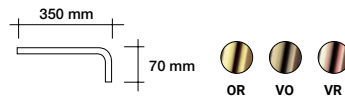

**05910CR35** Cromo | Chrome Ø21 mm - L 350 mm **75,00 €**

**05910OR35** Cromo | Chrome Ø21 mm - L 350 mm **105,00 €**

**05910VR35** Cromo | Chrome Ø21 mm - L 350 mm **105,00 €**

**05910VO35** Cromo | Chrome Ø21 mm - L 350 mm **105,00 €**

\* Misure speciali su richiesta \_ *Special measures on request*

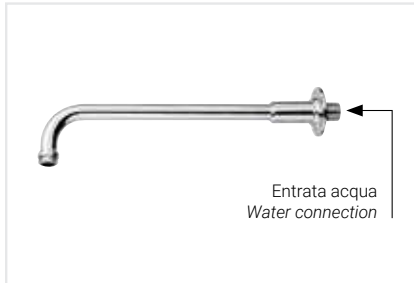

### LUX 18 OLD

Braccio con attacco a muro da 1/2" in **ottone** cromato Ø 18 mm. Con rosone regolabile.  
Chromed **brass** shower arm Ø 18 mm with wall connection 1/2" and adjustable rosette.

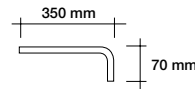

**05923CR35** Cromo | Chrome Ø18 mm - L 350 mm **75,00 €**

\* Misure speciali su richiesta \_ *Special measures on request*



### LUX 18 MODE

Braccio con attacco a muro da 1/2" in **ottone** cromato Ø 18 mm. Con rosone regolabile.  
Chromed **brass** shower arm Ø 18 mm with wall connection 1/2" and adjustable rosette.

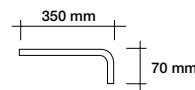

**05922CR35** Cromo | Chrome Ø18 mm - L 350 mm **75,00 €**

\* Misure speciali su richiesta \_ *Special measures on request*



### SOFFITTO TONDO

Braccio con **attacco** a soffitto da 1/2" in ottone cromato Ø 24 mm.  
Chromed **brass** shower arm Ø 24 mm with ceiling connection 1/2".

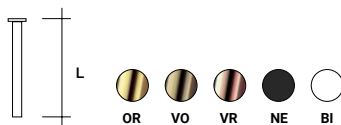

<b>05960CR15</b>	Cromo   Chrome	Ø24 mm - L 150 mm	<b>95,00 €</b>
<b>05960CR30</b>	Cromo   Chrome	Ø24 mm - L 300 mm	<b>115,00 €</b>

\* Misure speciali su richiesta \_ *Special measures on request*

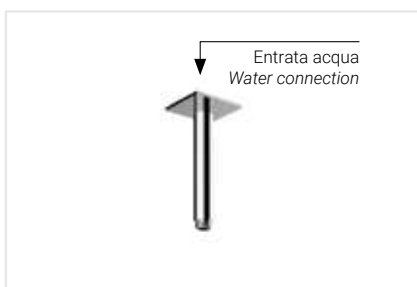

### WALL INOX

Braccio con attacco a soffitto da 1/2" in **acciaio inox** Ø 24 mm.  
**Stainless steel** shower arm Ø 24 mm with ceiling connection 1/2".

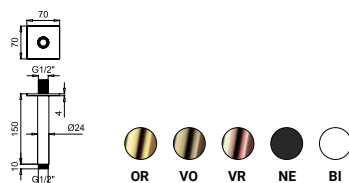

<b>05961CR15</b>	Cromo   Chrome	Ø24 mm - L 150 mm	<b>95,00 €</b>
<b>05961CR30</b>	Cromo   Chrome	Ø24 mm - L 300 mm	<b>115,00 €</b>

\* Misure speciali su richiesta \_ *Special measures on request*



### RETTANGOLARE

Braccio con attacco a muro da 1/2" in **ottone cromato** 30x10 mm.  
Chromed **brass** shower arm 30x10 mm with wall connection 1/2".

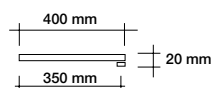

<b>06010CR40/35</b>	Cromo   Chrome	30x10 mm - L 400 mm	<b>109,00 €</b>
---------------------	----------------	---------------------	-----------------

\* Misure speciali su richiesta \_ *Special measures on request*



### QUADRO MINIMAL

Braccio con attacco a muro da 1/2" in ottone cromato 22x22 mm.  
Chromed brass shower arm 22x22 mm with wall connection 1/2".

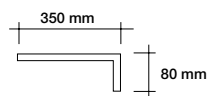

<b>05995CR35</b>	Cromo   Chrome	22x22 mm - L 350 mm	<b>133,00 €</b>
------------------	----------------	---------------------	-----------------

\* Misure speciali su richiesta \_ *Special measures on request*



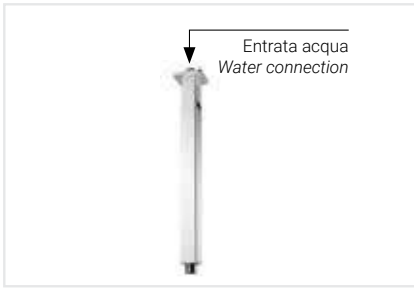

## SOFFITTO QUADRO

Braccio con attacco a soffitto da 1/2" in **ottone** cromato 30x30 mm.  
*Chromed brass shower arm 30x30 mm with ceiling connection 1/2".*



	Cromo   Chrome		
<b>05965CR10</b>	Cromo   Chrome	22x22 mm - L 100 mm	<b>54,00 €</b>
<b>05965CR20</b>	Cromo   Chrome	22x22 mm - L 200 mm	<b>62,00 €</b>
<b>05965CR30</b>	Cromo   Chrome	22x22 mm - L 300 mm	<b>74,00 €</b>
<b>05965CR40</b>	Cromo   Chrome	22x22 mm - L 400 mm	<b>86,00 €</b>

\* Misure speciali su richiesta \_ *Special measures on request*



## STANDARD

Braccio con attacco a muro da 1/2" in **ottone** cromato Ø 18 mm.  
*Chromed brass shower arm Ø 18 mm with wall connection 1/2".*

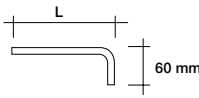

	Cromo   Chrome	Ø18 mm - L 200 mm	<b>16,30 €</b>
<b>04220CR20</b>	Cromo   Chrome	Ø18 mm - L 200 mm	<b>16,30 €</b>
<b>04220CR30</b>	Cromo   Chrome	Ø18 mm - L 300 mm	<b>18,00 €</b>
<b>04220CR35</b>	Cromo   Chrome	Ø18 mm - L 350 mm	<b>20,00 €</b>
<b>04220CR40</b>	Cromo   Chrome	Ø18 mm - L 400 mm	<b>22,00 €</b>

\* Misure speciali su richiesta \_ *Special measures on request*





## PARADISO

Braccio con attacco a muro da 1/2" in **ottone** cromato Ø 18 mm. Altezza totale 35 cm  
*Chromed brass shower arm Ø 18 mm with wall connection 1/2", total height 35 cm.*  
*Possibility to adjust the height of the arm.*

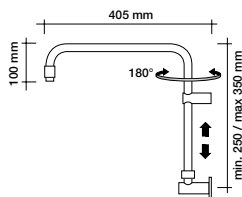

Possibilità di personalizzare l'altezza del braccio.  
*Possibility to adjust the height of the arm.*



**05936CR**

Cromo | Chrome

Ø18 mm - L 350 mm

**176,00 €**

\* Misure speciali su richiesta \_ *Special measures on request*



## ARCOBALENO

Braccio con attacco a muro da 1/2" in **ottone** cromato Ø 18 mm. Altezza totale 50 cm  
*Chromed brass shower arm Ø 18 mm with wall connection 1/2", total height 50 cm.*  
*Possibility to adjust the height of the arm.*

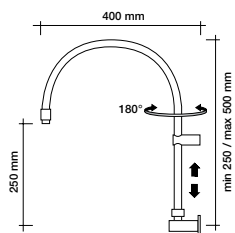

Possibilità di personalizzare l'altezza del braccio.  
*Possibility to adjust the height of the arm.*



**05980CR**

Cromo | Chrome

Ø18 mm - L 500 mm

**176,00 €**

\* Misure speciali su richiesta \_ *Special measures on request*

# PULIZIA E MANUTENZIONE DEI SOFFIONI

Cleaning and maintenance of shower heads



**PULIZIA DELLE PARTI METALLICHE:** l'acqua contiene calcio che si deposita sulla superficie dei prodotti e forma macchie sgradevoli. Per la normale pulizia del prodotto è sufficiente utilizzare un panno umido con un po' di sapone, sciacquare ed asciugare dopo ogni uso. Si consiglia di usare solamente detergenti a base di sapone. Non impiegare mai detergenti o disinfettanti abrasivi o contenenti alcool, acido cloridrico o acido fosforico, candeggina, cloro ecc.

**Pulizia degli ugelli in silicone:** i soffioni sono dotati di sistema "Easy-Clean" costituito da ugelli in silicone che con l'acqua calda si dilatano facendo così staccare il primo strato di calcare. Inoltre, passando periodicamente la mano sugli ugelli, essi si liberano facilmente dal calcare.

LA GARANZIA NON COPRE DANNI CAUSATI DA DEPOSITO DI CALCARE O IMPURITÀ.

**CLEANING OF METAL PARTS:** the water contains calcium that accumulates on the surface of the products and forms unsightly stains. For normal cleaning product simply use a cloth wet with a little of soap, rinse and dry after each use. We recommend to use only soap-based detergents. Never use detergents or abrasive cleaners or disinfectants containing alcohol, hydrochloric acid or phosphoric acid, bleach, chlorine etc.

**Cleaning of the nozzles in silicone:** the heads are equipped with the «Easy-Clean» constituted by nozzles in silicone that with the hot water dilate doing so remove the first layer of limestone. In addition, periodically passing his hand over his nipples, they easily release from limestone.

THE WARRANTY DOES NOT COVER DAMAGE CAUSED BY LIMESCALE AND IMPURITIES.

Per i modelli / For models:  
DELTA / SCIROCCO



PIASTRA  
PLATE

MEMBRANA  
IN SILICONE  
SYLICONE  
MEMBRANE

CALOTTA  
COVER

Per i modelli / For models:  
BORA / NETTUNO / OMEGA / EROS



## PULIZIA E MANUTENZIONE DEI SOFFIONI

Cleaning and maintenance of shower heads

FACILITÀ DI MANUTENZIONE E PULIZIA GRAZIE AL COMPLETO SMONTAGGIO DELLE SINGOLE PARTI.  
*EASY MAINTENANCE AND CLEANING THANKS TO TOTAL DEMOUNTING OF EACH PART.*

Se deteriorata, la membrana può essere sostituita \_ *Possibility to replace the membrane if deteriorated*



Pulizia degli ugelli in silicone: i soffioni sono dotati di sistema "Easy-Clean" costituito da ugelli in silicone che con l'acqua calda si dilatano facendo così staccare il primo strato di calcare. Inoltre, passando periodicamente la mano sugli ugelli, essi si liberano facilmente dal calcare. Consigliamo inoltre di immergere periodicamente i soffioni ispezionabili smontati in acqua e aceto per 24 h.

*Cleaning of the nozzles in silicone: the heads are equipped with the "Easy-Clean" system constituted by nozzles in silicone that with the hot water dilate doing so remove the first layer of limestone. In addition, periodically passing his hand over his nipples, they easily release from limestone. We also advise you to dip the inspectionable shower heads disassembled in water and vinegar for 24 h.*

## PARETE ATTREZZATA



cod. KITPARETET **2.850,00 €** - termostatico | *thermostatic*  
cod. KITPARETEM **2.550,00 €** - monocomando | *single lever*

Immagine a titolo esemplificativo \_ *Image as an example*

Kit composto da braccio QUADRO MINIMAL, soffione NETTUNO, 4 body jets, miscelatore termostatico incasso a 3 vie, presa acqua e supporto, doccetta CUBE e flessibile.

*Thermostatic shower kit including shower arm QUADRO MINIMAL, shower head NETTUNO, 4 BODY JETS, built-in thermostatic mixer 3-ways, water supply and shower holder, hand shower CUBE and flexible hose.*



Kit braccio + soffione PENELOPE. Presa acqua tonda con portadoccia, flessibile D/A cm 150, doccia CIGAR.  
*Kit arm + Shower-head PENELOPE. Water supply round with shower holder, flexible D/A length cm 150, hand shower CIGAR.*



<b>K05330CR200PAD</b>	Cromo   Chrome	<b>338,00 €</b>
<b>K05330CR250PAD</b>	Cromo   Chrome	<b>383,00 €</b>
<b>K05330CR300PAD</b>	Cromo   Chrome	<b>438,00 €</b>

\* Misure speciali su richiesta \_ *Special measures on request*



Kit braccio + soffione PERICLE. Presa acqua quadra con portadoccia, flessibile D/A cm 150, doccia CUBE.  
*Kit arm + Shower-head PERICLE. Water supply square with shower holder, flexible D/A cm 150, hand shower Cube.*



<b>K05730Q20PAD</b>	Cromo   Chrome	<b>401,00 €</b>
<b>K05730Q25PAD</b>	Cromo   Chrome	<b>466,00 €</b>
<b>K05730Q30PAD</b>	Cromo   Chrome	<b>521,00 €</b>







\* Misure speciali su richiesta \_ *Special measures on request*



# SALISCENDI

## SHOWER BARS

FINITURE SPECIALI SU RICHIESTA:  
SPECIAL FINISHING ON REQUEST:

-  **OR** Oro | Gold
-  **VO** Vecchio Ottone | Old Brass
-  **VR** Vecchio Rame | Old Copper
-  **NS** Nickel Spazzolato | Satin Nickel
-  **BS** Acciaio Spazzolato | Brushed Stainless Steel
-  **NE** Nero | Black
-  **BI** Bianco | White

Sugli articoli in finitura speciale si potrebbero presentare delle imperfezioni, dovute al tipo di lavorazione.  
*Please kindly note that on items in special finishing you may have imperfections due to the type of machining.*



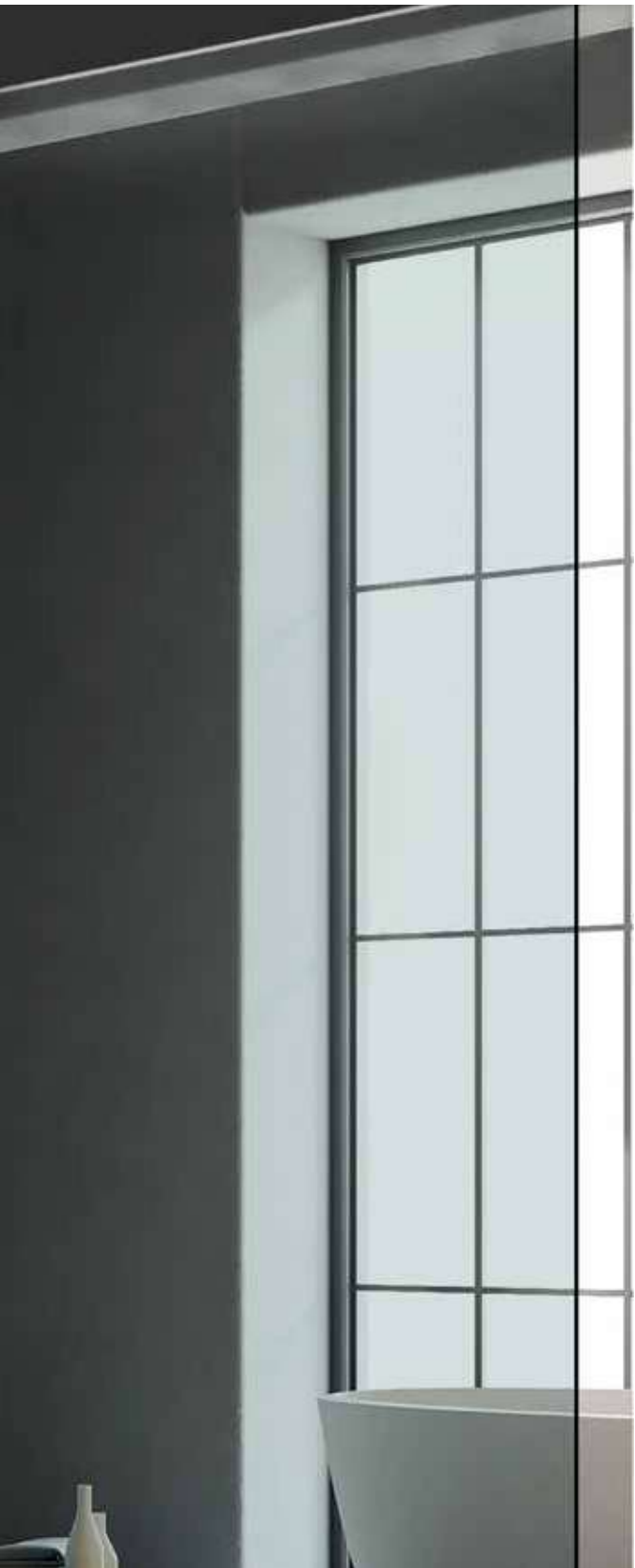

SALISCENDI



# SALISCENDI

## SHOWER BARS

	PAG.
○ MERCURIO	180
○ PACIFICO INFERIORE	182
○ PACIFICO SUPERIORE	183
○ SLIM PIÙ	184
○ URAGANO PIÙ	186
○ GIOVE PIÙ	188
○ DELFINO PIÙ	190
○ MOVIE TONDO	192
□ PARALLEL	194
○ SLIM	196
□ QUARZO / QUARZO PIÙ	198
□ QUARZO ORIENTABILE	200
◇ DIAMANTE	202
○ OPALE	204
○ ACQUARIO	206
○ TUCANO / TUCANO CRYSTAL	208
○ SIRIO	210
○ GIOVE / GIOVE CRYSTAL	212
○ DELFINO	214
□ AIRONE	216

### **Caratteristiche:**

Supporti + scorrevole portadoccia + tubo completamente in OTTONE

### **Specifics:**

*All in BRASS: sliding rail bracket + sliding bar shower holder + tube*

### **Caratteristiche:**

Supporti + scorrevole portadoccia ABS + tubo in OTTONE

### **Specifics:**

*ABS sliding rail bracket + ABS sliding bar shower holder + BRASS tube*



### MERCURIO

Rampa in abs/ottone.  
Brass/abs sliding bar.



**18900CR** Ø 25 mm **102,00 €**

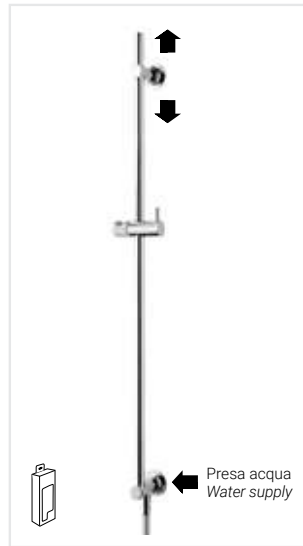

### PACIFICO INFERIORE

Rampa in ottone.  
Compreso di flessibile 15x1  
Brass sliding bar.  
Included flexible hose 15x1.



**29900CRINF** Ø 18 mm **218,00 €**



### PACIFICO SUPERIORE

Rampa in ottone.  
Compreso di flessibile 15x1  
Brass sliding bar.  
Included flexible hose 15x1.



**29900CRSUP** Ø 18 mm **218,00 €**

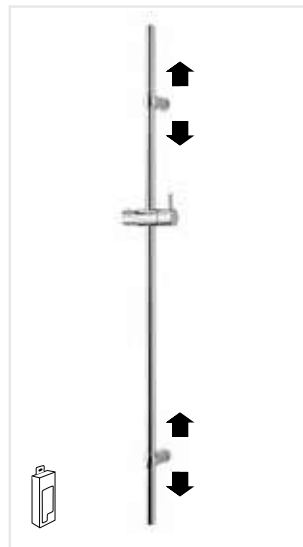

### SLIM PIÙ

Rampa in ottone.  
Brass sliding bar.



**21900CR90** Ø 18 mm **149,00 €**  
**21900CR120** Ø 18 mm **157,00 €**  
**21900NE90** Ø 20 mm **280,00 €**  
**21900BI90** Ø 20 mm **280,00 €**

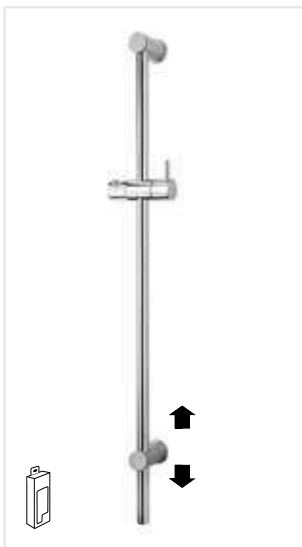

### URAGANO PIÙ

Rampa in ABS.  
ABS sliding bar.



**73900CR** Ø 22 mm **58,50 €**  
**73900NE** Ø 22 mm **61,00 €**  
**73900BI** Ø 22 mm **61,00 €**

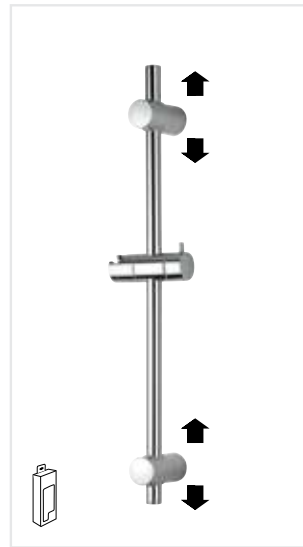

### GIOVE PIÙ

Rampa in ABS.  
ABS sliding bar.



**27900PCR** Ø 22 mm **49,50 €**

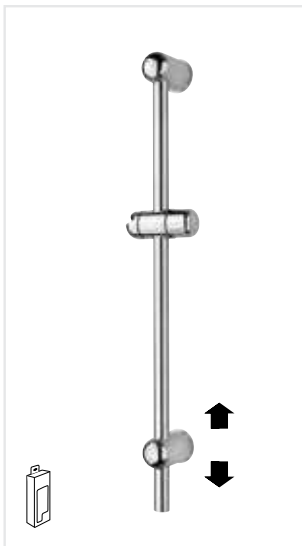

### DELFINO PIÙ

Rampa in ABS.  
ABS sliding bar.



**14900CR** Ø 25 mm **48,50 €**

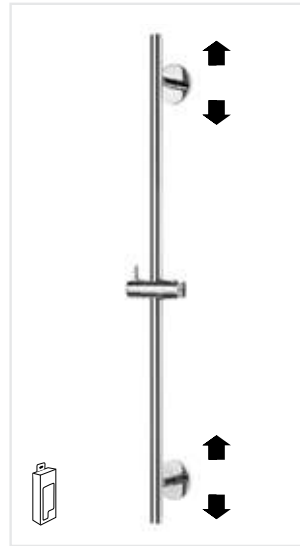

### MOVIE TONDO

Rampa in ABS.  
ABS sliding bar.



**40900PCR80** Ø 20 mm **124,00 €**  
**40900PCR100** Ø 20 mm **134,00 €**  
**40900PNE80** Ø 20 mm **160,00 €**  
**40900PNE100** Ø 20 mm **172,00 €**  
**40900PBI80** Ø 20 mm **160,00 €**  
**40900PBI100** Ø 20 mm **172,00 €**



### PARALLELE

Rampa in ABS.  
ABS sliding bar.



**41900PCR** 16x16 mm **110,00 €**  
**41900PNE** 16x16 mm **145,00 €**  
**41900PBI** 16x16 mm **145,00 €**

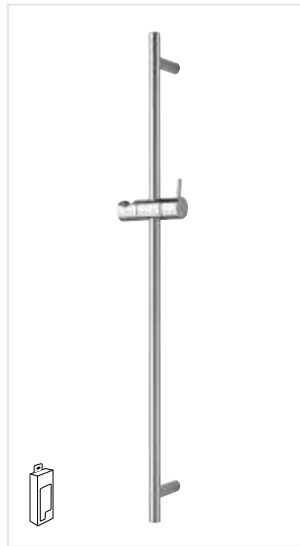

### SLIM

Rampa in ottone.  
Brass sliding bar.



**19900CR70** Ø 18 mm **116,00 €**  
**19900CR90** Ø 18 mm **128,00 €**



### QUARZO

Rampa in ottone.  
Brass sliding bar.



**23900CR70** 16x16 mm **180,00 €**  
**23900CR90** 16x16 mm **187,00 €**



### QUARZO PIÙ

Rampa in ottone.  
Brass sliding bar.



**23900CR90P** 16x16 mm **192,00 €**



### QUARZO ORIENTABILE

Rampa in ottone.  
Brass sliding bar.



 OTTONE  
BRASS

**74900CR** 16x16 mm **230,00 €**



### DIAMANTE

Rampa in ottone.  
Brass sliding bar.



 OTTONE  
BRASS

**22900CR70** 16x16 mm **207,00 €**  
**22900CR90** 16x16 mm **213,00 €**



### OPALE

Rampa in ottone.  
Brass sliding bar.



 OTTONE  
BRASS

**24900CR70** Ø 18 mm **149,00 €**



### ACQUARIO

Rampa in ottone.  
Brass sliding bar.



  
OR VO VR

 OTTONE  
BRASS

**15900CR** Ø 18 mm **176,00 €**  
**15900OR** Ø 18 mm **245,00 €**  
**15900VR** Ø 18 mm **245,00 €**  
**15900VO** Ø 18 mm **245,00 €**



### TUCANO

Rampa in ottone.  
Brass sliding bar.



  
OR VO VR

 OTTONE  
BRASS

**20900CR** Ø 25 mm **117,00 €**  
**20900OR** Ø 25 mm **164,00 €**  
**20900VR** Ø 25 mm **164,00 €**  
**20900VO** Ø 25 mm **164,00 €**



### TUCANO CRYSTAL

Rampa in ottone con  
portasapone TRAIL.  
Brass sliding bar  
with TRAIL.



 OTTONE  
BRASS

**2000062VT** Ø 25 mm **169,00 €**



### SIRIO

Rampa in ABS.  
ABS sliding bar.



**10900CR** Ø 25 mm **68,00 €**



### GIOVE

Rampa in ABS.  
ABS sliding bar.



**27900CR** Ø 25 mm **47,50 €**



### GIOVE CRYSTAL

Rampa in ABS con  
portasapone TRAIL.  
ABS sliding bar with TRAIL.



**2700062VT** Ø 25 mm **97,00 €**



### DELFINO

Rampa in ABS.  
ABS sliding bar.



**11900CR** Ø 25 mm **36,00 €**



### AIRONE

Rampa in ABS.  
ABS sliding bar.



**26900CR** Ø 25 mm **97,00 €**

**26900CRANG** Ø 25 mm **99,00 €**

Versione ad angolo \_ Corner version





**PORTASAPONE  
CRYSTAL  
FORO SEZIONE TONDA  
Ø 25 mm - per saliscendi**

Portasapone in metacrilato trasparente.  
*Soap shelf, transparent methacrylate, round section Ø 25 mm.*



**50260TVT25** 310x135 mm **57,00 €**



**PORTASAPONE  
CRYSTAL  
FORO SEZIONE TONDA  
Ø 18 mm - per saliscendi**

Portasapone in metacrilato trasparente.  
*Soap shelf, transparent methacrylate, round section Ø 18 mm.*



**50260TVT18** 310x135 mm **57,00 €**



## MERCURIO



Presca  
acqua  
integrata.  
*Integrated  
water  
supply.*

rampa **MERCURIO** con doccia **SMALL MONO** - finitura cromo

Completo saliscendi con supporto superiore, presa acqua e asta in ottone Ø 25 mm, altezza 80 cm. Scorrevole centrale in ABS. Flessibile doppia aggraffatura con attacco conico, lunghezza 200 cm. Base porta oggetti integrata, brevettata.

*Brass sliding railset with integrated water supply, tube Ø 25 mm, height 80 cm. ABS shower holder. Double interlock flexible hose with conical nut, length 200 cm. integrated soap dish patented.*

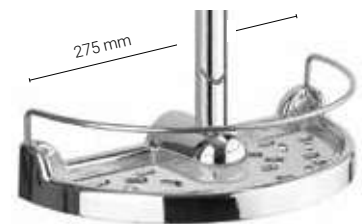

Base porta oggetti integrata e brevettata con piattino.  
*Integrated soap dish patented with dish.*

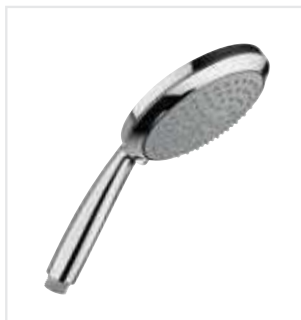

+

**ABIS**

Doccia multigetto ANTICALCARE.  
*ANTISCALE multi jet shower.*



**18445CR**    Ø 140 mm    **177,00 €**

+

**SMALL MONO**

Doccia monogetto ANTICALCARE.  
*ANTISCALE single jet shower.*



**18033CR**    Ø 80 mm    **137,00 €**

+

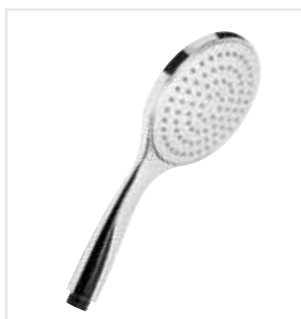
**AIR WATER Ø 130**

Doccia monogetto a  
 miscelazione aria/acqua  
*Single jet mixing air/water shower*

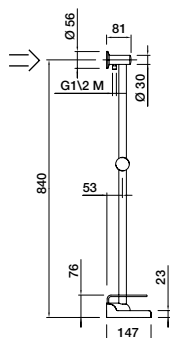

**18585CR**    Ø 130 mm    **185,00 €**

**Rampa MERCURIO**

Imballo standard **12 PEZZI**  
 Packaging standard **12 PCS**

## PACIFICO INFERIORE

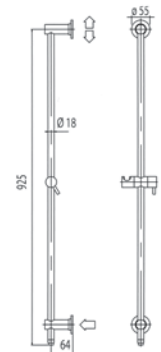

rampa **PACIFICO INFERIORE** con doccia **AIR WATER Ø 100** - finitura cromo

Completo saliscendi in ottone con asta Ø 18 mm altezza 90 cm. Flessibile doppia aggraffatura con attacchi 15 x 1 - 1/2" conico, 150 cm. SUPPORTO INFERIORE CON PRESA ACQUA INTEGRATA. Supporto superiore scorrevole per interasse variabile.

*Brass sliding railset with tube Ø 18 mm, height 90 cm. Double interlock flexible hose 15 x 1 - 1/2" conical nut, length 150 cm. LOWER BRACKET WITH INTEGRATED WATER SUPPLY. Superior bracket adjustable.*



**29580CRINF** Ø 100 mm **286,00 €**



# PACIFICO SUPERIORE

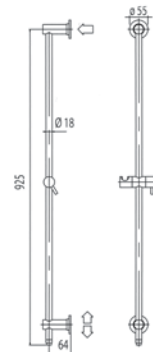

rampa PACIFICO SUPERIORE con doccia AIR WATER Ø 100 - finitura cromo

Completo saliscendi in ottone con asta Ø 18 mm altezza 90 cm. Flessibile doppia aggraffatura con attacchi 15 x 1 - 1/2" conico, 150 cm. SUPPORTO SUPERIORE CON PRESA ACQUA INTEGRATA. Supporto inferiore scorrevoile per interasse variabile.

*Brass sliding railset with tube Ø 18 mm, height 90 cm. Double interlock flexible hose 15 x 1 - 1/2" conical nut, length 150 cm. SUPERIOR BRACKET WITH INTEGRATED WATER SUPPLY. Lower bracket adjustable.*



**29580CRSUP** Ø 100 mm **286,00 €**



## SLIM PIÙ



rampa **SLIM PIÙ** con doccia **CIGAR** - finitura nero

Immagine a titolo esemplificativo \_ *Image as an example*

Completo saliscendi interamente in ottone con asta  $\varnothing$  18 mm, altezza 90/120 cm. Supporti a muro telescopici con interasse variabile per fori già esistenti. Flessibile doppia aggraffatura con attacco conico girevole, lunghezza 150 cm.

*Brass sliding railset with tube  $\varnothing$  18 mm, height 90/120 cm. Double interlock flexible hose with swiveling conical nut, length 150 cm. Telescopic wall brackets adjustable for existing holes.*





Rampa SLIM PIÙ

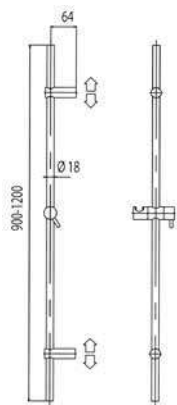

Imballo standard 12 PEZZI  
Packaging standard 12 PCS

+

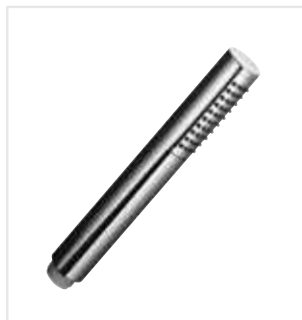

## CIGAR

Doccia monogetto ANTICALCARE.  
ANTISCALE single jet shower.



<b>21141CR90</b>	Ø 26 mm	<b>183,00 €</b>
<b>21141CR120</b>	Ø 26 mm	<b>193,00 €</b>
<b>21141NE90</b>	Ø 26 mm	<b>325,00 €</b>
<b>21141BI90</b>	Ø 26 mm	<b>325,00 €</b>

+



## SMALL MULTI Ø 100

Doccia multigetto ANTICALCARE.  
ANTISCALE multi jet shower.



<b>21661CR90</b>	Ø 100 mm	<b>229,00 €</b>
<b>21661CR120</b>	Ø 100 mm	<b>239,00 €</b>
<b>21661NE90</b>	Ø 100 mm	<b>380,00 €</b>
<b>21661BI90</b>	Ø 100 mm	<b>380,00 €</b>

+

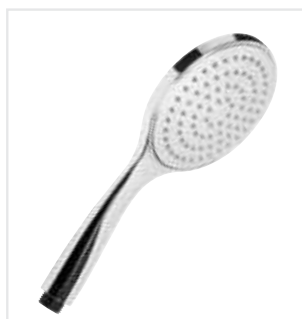

## AIR WATER Ø 100

Doccia monogetto a  
miscelazione aria/acqua.  
Single jet mixing air/water shower.



<b>21580CR90</b>	Ø 100 mm	<b>213,00 €</b>
<b>21580CR120</b>	Ø 100 mm	<b>221,00 €</b>
<b>21580NE90</b>	Ø 100 mm	<b>360,00 €</b>
<b>21580BI90</b>	Ø 100 mm	<b>360,00 €</b>

+



## SOANA

Doccia multigetto ANTICALCARE  
con pulsante tutta cromata.  
ANTISCALE multi jet shower  
with button all chromed.



<b>21635CR90</b>	Ø 120 mm	<b>222,00 €</b>
<b>21635CR120</b>	Ø 120 mm	<b>232,00 €</b>

## URAGANO PIÙ



rampa URAGANO PIÙ con doccia ARIES - finitura cromo

Completo saliscendi in abs con asta in ottone Ø 22 mm, altezza 90 cm. Flessibile doppia aggraffatura con attacco conico girevole, lunghezza 150 cm. Supporto inferiore scorrevole.

*Sliding railset in chrome-plated ABS with brass tube Ø 22 mm, height 90 cm. Double interlock flexible hose with swiveling conical nut, 150 cm long. Lower bracket adjustable.*





↑  
Interasse  
variabile.  
↓  
Variable  
distance.

Rampa URAGANO PIÙ

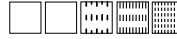
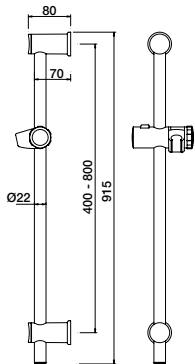

### ARIES

Doccia multigetto ANTICALCARE.  
ANTISCALE multi jet shower.



**73360CR** Ø 75 mm **97,00 €**

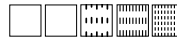

### SPRING MULTI

Doccia multigetto ANTICALCARE.  
ANTISCALE multi jet shower.



**73403CR** Ø 80 mm **109,00 €**



### SMALL MULTI Ø 100

Doccia multigetto ANTICALCARE.  
ANTISCALE multi jet shower.



**73661CR** Ø 100 mm **138,00 €**



Imballo standard **12 PEZZI**  
Packaging standard **12 PCS**

## GIOVE PIÙ



rampa GIOVE PIÙ con doccia SPRING MULTI - finitura cromo

Immagine a titolo esemplificativo \_ Image as an example

Saliscendi in ABS con asta Ø 22 mm, altezza 80 cm. Flessibile doppia aggraffatura con attacco conico girevole, lunghezza 150 cm.

*ABS sliding railset, tube Ø 22 mm, height 80 cm.  
Double interlock flexible hose with swiveling conical nut, length 150 cm.*



+

**PLANET**

Doccia multigetto ANTICALCARE.  
ANTISCALE multi jet shower.



**27460PCR** Ø 104 mm **99,50 €**

+

**SMALL MONO**

Doccia monogetto ANTICALCARE.  
ANTISCALE single jet shower.



**27033PCR** Ø 80 mm **84,50 €**

+

**SPRING MULTI**

Doccia multigetto ANTICALCARE.  
ANTISCALE multi jet shower.

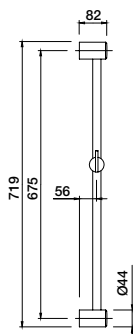

**27403PCR** Ø 80 mm **103,00 €**

**Rampa GIOVE PIÙ**

Imballo standard **12 PEZZI**  
Packaging standard **12 PCS**

## DELFINO PIÙ



rampa DELFINO PIÙ con doccia LUNA - finitura cromo - portasapone su richiesta

Completo saliscendi in ABS con asta  
in ottone Ø 25 mm, altezza 70 cm.  
Flessibile doppia aggraffatura con attacco  
conico girevole, lunghezza 150 cm.  
**Supporto inferiore scorrevole.**

*Sliding railset in chrome-plated ABS  
with brass tube Ø 25 mm, height 70 cm.  
Double interlock flexible hose  
with conical nut, 150 cm long.  
**Sliding lower bracket.***





Rampa DELFINO PIÙ

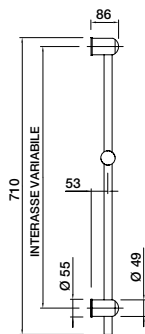

Imballo standard 12 PEZZI  
Packaging standard 12 PCS

+

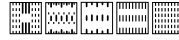

### JOKER

Doccia multigetto ANTICALCARE.  
ANTISCALE multi jet shower.



14434CR Ø 84 mm 91,00 €

+

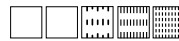

### LUNA

Doccia multigetto ANTICALCARE.  
ANTISCALE multi jet shower.



14410CR Ø 100 mm 98,50 €

+

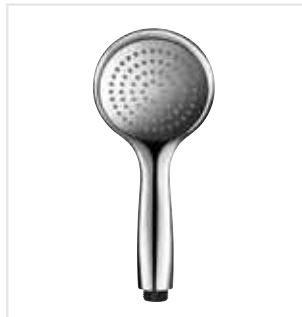

### SOFT MONO 100

Doccia monogetto ANTICALCARE.  
ANTISCALE single jet shower.



14581CR Ø 71 mm 120,00 €

+



### SMILE

Doccia multigetto ANTICALCARE.  
ANTISCALE multi jet shower.



14402CR Ø 95 mm 99,00 €

## MOVIE TONDO



rampa **MOVIE TONDO** con doccia **doccia SOFT MULTI 100** - finitura cromo

Immagine a titolo esemplificativo \_ *Image as an example*

Completo saliscendi in ottone con scorrevole e supporti Ø 20 mm in ABS, altezza 80 o 100 cm. Interasse variabile 48-72 cm o 68-92 cm. Flessibile lunghezza 150 cm.

*Sliding railset with ABS shower holder and brackets, brass tube Ø 20 mm, height 80 or 100 cm. Variable distance 48-72 cm or 68-92. Flexible hose length 150 cm.*



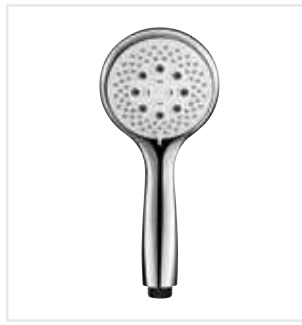

### SOFT MULTI 100

Doccia multigetto ANTICALCARE.  
ANTISCALE multi jet shower.



<b>40663PCR80</b>	Ø 100 mm	<b>188,00 €</b>
<b>40663PCR100</b>	Ø 100 mm	<b>200,00 €</b>
<b>40663PBI80</b>	Ø 100 mm	<b>260,00 €</b>
<b>40663PBI100</b>	Ø 100 mm	<b>272,00 €</b>
<b>40663PNE80</b>	Ø 100 mm	<b>260,00 €</b>
<b>40663PNE100</b>	Ø 100 mm	<b>272,00 €</b>

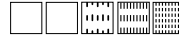

### ARIES

Doccia multigetto ANTICALCARE.  
ANTISCALE multi jet shower.



<b>40360PCR80</b>	Ø 75 mm	<b>154,00 €</b>
-------------------	---------	-----------------

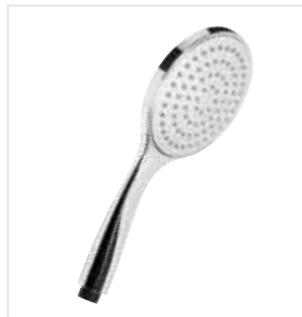
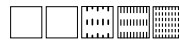

### AIR WATER Ø 100

Doccia monogetto a  
miscelazione aria/acqua.  
Single jet mixing air/water shower.



<b>40580PCR80</b>	Ø 100 mm	<b>173,00 €</b>
<b>40580PCR100</b>	Ø 100 mm	<b>185,00 €</b>
<b>40580PBI80</b>	Ø 100 mm	<b>244,00 €</b>
<b>40580PBI100</b>	Ø 100 mm	<b>256,00 €</b>
<b>40580PNE80</b>	Ø 100 mm	<b>244,00 €</b>
<b>40580PNE100</b>	Ø 100 mm	<b>256,00 €</b>

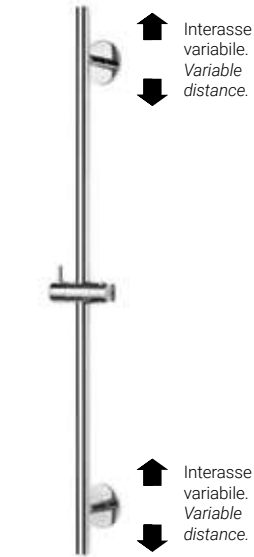

Rampa MOVIE TONDO

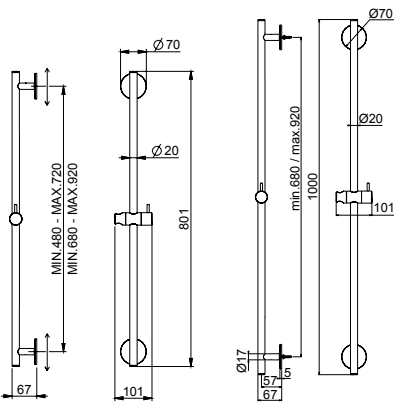

Imballo standard 12 PEZZI  
Packaging standard 12 PCS



### LUNA

Doccia multigetto ANTICALCARE.  
ANTISCALE multi jet shower.



<b>40410PCR80</b>	Ø 100 mm	<b>160,00 €</b>
-------------------	----------	-----------------



## PARALLEL



rampa **PARALLEL** con doccia **MINI RETTANGOLARE** - finitura cromo

Immagine a titolo esemplificativo \_ *Image as an example*

Completo saliscendi in ottone con scorrevole  
16x16 mm e supporti in ABS, altezza 70 cm.  
Flessibile lunghezza 150 cm.

*Sliding railset with shower holder and brackets,  
brass tube 16x16 mm, height 70 cm.  
Flexible hose length 150 cm.*





Rampa **PARALLEL**

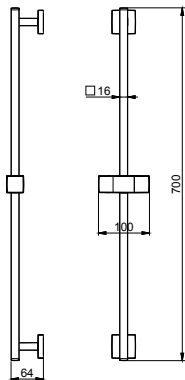

Imballo standard **12 PEZZI**  
Packaging standard **12 PCS**

+



### CUBE

Doccia monogetto ANTICALCARE.  
*ANTISCALE single jet shower.*



**41261PCR** 27x27 mm **163,00 €**

+



### MINI RETTANGOLARE

Doccia monogetto ANTICALCARE.  
*ANTISCALE single jet shower.*



**41260PCR** 32 x 15 mm **226,00 €**

+



### PLANET

Doccia multigetto ANTICALCARE.  
*ANTISCALE multi jet shower.*



**41460PCR** Ø 104 mm **163,00 €**

+



### RIPA

Doccia multigetto ANTICALCARE  
con pulsante tutta cromata.  
*ANTISCALE multi jet shower  
with button all chromed .*



**41535PCR** Ø 104 mm **192,00 €**

+



### AIR WATER Ø 100

Doccia monogetto a  
miscelazione aria/acqua.  
*Single jet mixing air/water shower.*



**41580PCR** Ø 100 mm **174,00 €**

**41580PBI** Ø 100 mm **232,00 €**

**41580PNE** Ø 100 mm **232,00 €**

## SLIM



rampa **SLIM** con doccia **AIR WATER Ø 100** - finitura cromo

Immagine a titolo esemplificativo \_ *Image as an example*

Completo saliscendi interamente in ottone con asta Ø 18 mm, altezza 70/90 cm. Flessibile doppia aggraffatura con attacco conico girevole, lunghezza 150 cm.

*Brass sliding railset, tube Ø 18 mm, height 70/90 cm. Double interlock flexible hose with swiveling conical nut, length 150 cm.*





Rampa SLIM

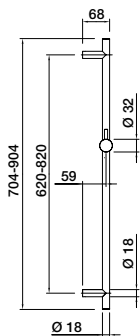

Imballo standard 12 PEZZI  
Packaging standard 12 PCS

+



### ANTQUA

Doccia monogetto ANTICALCARE.  
ANTISCALE single jet shower.



**19180CER** Ø 52 mm 251,00 €

+



### LUNA

Doccia multigetto ANTICALCARE.  
ANTISCALE multi jet shower.



**19410CR70** Ø 100 mm 163,00 €

**19410CR90** Ø 100 mm 173,00 €

+



### CIGAR

Doccia monogetto ANTICALCARE.  
ANTISCALE single jet shower.



**19141CR70** Ø 26 mm 148,00 €

**19141CR90** Ø 26 mm 158,00 €

+



### AIR WATER Ø 100

Doccia monogetto a  
miscelazione aria/acqua.  
Single jet mixing air/water shower.



**19580CR70** Ø 100 mm 177,00 €

**19580CR90** Ø 100 mm 187,00 €

+



### SMALL MULTI Ø 80

Doccia multigetto ANTICALCARE.  
ANTISCALE multi jet shower.



**19066CR70** Ø 82 mm 162,00 €

**19066CR90** Ø 82 mm 172,00 €

+

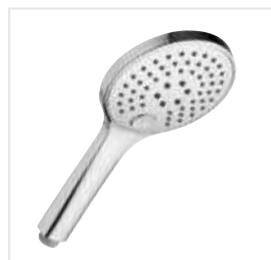

### SOANA

Doccia multigetto ANTICALCARE  
con pulsante tutta cromata  
ANTISCALE multi jet shower  
with button all chromed



**19635CR70** Ø 120 mm 187,00 €

**19635CR90** Ø 120 mm 197,00 €

## QUARZO - QUARZO PIÙ



**cod. 23535CR70**  
rampa QUARZO con doccia RIPA - finitura cromo

**cod. 23535CR90P**  
rampa QUARZO PIÙ con doccia RIPA - finitura cromo

Completo saliscendi interamente in ottone con asta  $\square$  16 mm, altezza 70/90 cm. Flessibile doppia aggraffatura con attacco conico girevole, lunghezza 150 cm.

*Brass sliding railset, tube  $\square$  16 mm, height 70/90 cm. Double interlock flexible hose with swiveling conical nut, length 150 cm.*

Completo saliscendi interamente in ottone con asta 16 mm, altezza 90 cm, interasse variabile. Flessibile doppia aggraffatura con attacco conico girevole, lunghezza 150 cm.

*Brass sliding railset, tube 16 mm, height 90 cm, variable distance. Double interlock flexible hose with swiveling conical nut, length 150 cm.*





### RIPA

Doccia multigetto ANTICALCARE con pulsante tutta cromata. ANTISCALE multi jet shower with button all chromed.



<b>23535CR70</b>	250x120 mm	<b>255,00 €</b>
<b>23535CR90</b>	250x120 mm	<b>265,00 €</b>
<b>23535CR90P</b>	250x120 mm	<b>270,00 €</b>



### CUBE

Doccia monogetto ANTICALCARE. ANTISCALE single jet shower.



<b>23261CR70</b>	27x27 mm	<b>226,00 €</b>
<b>23261CR90</b>	27x27 mm	<b>236,00 €</b>
<b>23261CR90P</b>	27x27 mm	<b>241,00 €</b>



### MINI QUADRA

Doccia monogetto ANTICALCARE. ANTISCALE single jet shower.



<b>23200CR70</b>	22x22 mm	<b>271,00 €</b>
<b>23200CR90</b>	22x22 mm	<b>281,00 €</b>
<b>23200CR90P</b>	22x22 mm	<b>286,00 €</b>



Rampa QUARZO / QUARZO PIÙ

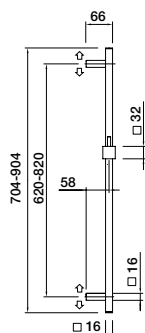

Imballo standard 12 PEZZI  
Packaging standard 12 PCS

## QUARZO ORIENTABILE



rampa **QUARZO ORIENTABILE** con doccia **CUBE** - finitura cromo

Completo saliscendi interamente in ottone con asta  $\square$  16 mm, altezza 70/90 cm. Flessibile doppia aggraffatura con attacco conico girevole, lunghezza 150 cm.

*Brass sliding railset, tube  $\square$  16 mm, height 70/90 cm. Double interlock flexible hose with swiveling conical nut, length 150 cm.*

 UAMI  
n° 000156617 - 0002  
Brevetto Europeo



+

**RIPA**

Doccia multigetto ANTICALCARE con pulsante tutta cromata. *ANTISCALE multi jet shower with button all chromed.*



**74535CR** 250x120 mm **305,00 €**

+

**CUBE**

Doccia monogetto ANTICALCARE. *ANTISCALE single jet shower.*



**74261CR** 27x27 mm **276,00 €**

+

**PLANET**

Doccia multigetto ANTICALCARE. *ANTISCALE multi jet shower.*

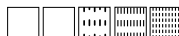

**74460CR** Ø 104 mm **281,00 €**



Rampa **QUARZO ORIENTABILE**

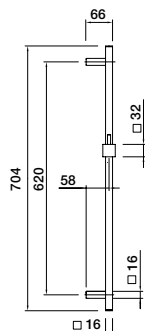

Imballo standard **12 PEZZI**  
Packaging standard **12 PCS**

## DIAMANTE



rampa **DIAMANTE** con doccia **CUBE** - finitura cromo

Immagine a titolo esemplificativo \_ *Image as an example*

Completo saliscendi interamente in ottone con asta  $\diamond$  16 mm, altezza 70/90 cm. Flessibile doppia aggraffatura con attacco conico girevole, lunghezza 150 cm.

*Brass sliding railset, tube  $\diamond$  16 mm, height 70/90 cm. Double interlock flexible hose with swiveling conical nut, length 150 cm.*



UAMI  
n° 000156617 - 0002  
Brevetto Europeo





### CUBE

Doccia monogetto ANTICALCARE.  
ANTISCALE single jet shower.



<b>22261CR70</b>	27x27 mm	<b>253,00 €</b>
<b>22261CR90</b>	27x27 mm	<b>263,00 €</b>



### MINI QUADRA

Doccia monogetto ANTICALCARE.  
ANTISCALE single jet shower.



<b>22200CR70</b>	22x22 mm	<b>298,00 €</b>
<b>22200CR90</b>	22x22 mm	<b>308,00 €</b>



Rampa DIAMANTE

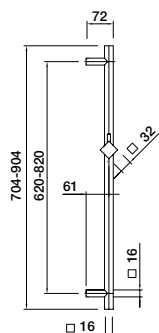

Imballo standard **12 PEZZI**  
Packaging standard **12 PCS**

## OPALE



rampa **OPALE** con doccia **STICK** - finitura cromo

Immagine a titolo esemplificativo \_ Image as an example

Completo saliscendi interamente in ottone con asta  $\varnothing$  18 mm, altezza 70 cm. Flessibile doppia aggraffatura con attacco conico girevole, lunghezza 150 cm.

*Brass sliding railset, tube  $\varnothing$  18 mm, height 70 cm. Double interlock flexible hose with swiveling conical nut, length 150 cm.*





Rampa OPALE

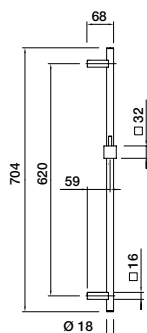

+



### STICK

Doccia monogetto ANTICALCARE.  
ANTISCALE single jet shower.



**24140CR70** Ø 27 mm **182,00 €**

+



### CUBE

Doccia monogetto ANTICALCARE.  
ANTISCALE single jet shower.



**24261CR70** 27x27 mm **193,00 €**

+



### RIPA

Doccia multigetto ANTICALCARE  
con pulsante tutta cromata.  
ANTISCALE multi jet shower  
with button all chromed.



**24535CR70** 250x120 mm **222,00 €**



Imballo standard **12 PEZZI**  
Packaging standard **12 PCS**

## ACQUARIO



rampa ACQUARIO con doccia ANTIQUA - finitura cromo



rampa ACQUARIO con doccia EPOQUE - finitura rame

Completo saliscendi interamente in ottone con asta in ottone  $\varnothing$  18 mm, altezza 60 cm. Flessibile doppia aggraffatura con attacco conico girevole, lunghezza 150 cm.

*Brass sliding railset, tube  $\varnothing$  18 mm, height 60 cm. Double interlock flexible hose with swiveling conical nut, length 150 cm.*



+

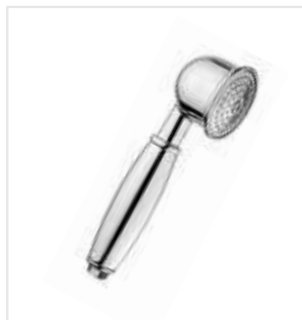

## ANTQUA

Doccia monogetto ANTICALCARE.  
ANTISCALE single jet shower.



<b>15180CR</b>	Ø 52 mm	<b>225,00 €</b>
<b>15180VR</b>	Ø 52 mm	<b>296,00 €</b>
<b>15180VO</b>	Ø 52 mm	<b>296,00 €</b>
<b>15180OR</b>	Ø 52 mm	<b>296,00 €</b>
<b>15180CER</b>	Ø 52 mm	<b>251,00 €</b>



+

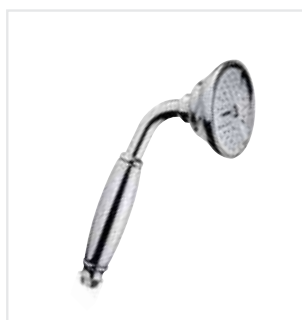

## BELLE EPOQUE

Doccia monogetto ANTICALCARE.  
ANTISCALE single jet shower.



<b>15190CR</b>	Ø 75 mm	<b>238,00 €</b>
<b>15190VR</b>	Ø 75 mm	<b>305,00 €</b>
<b>15190VO</b>	Ø 75 mm	<b>305,00 €</b>
<b>15190OR</b>	Ø 75 mm	<b>305,00 €</b>
<b>15190CER</b>	Ø 75 mm	<b>255,00 €</b>



+

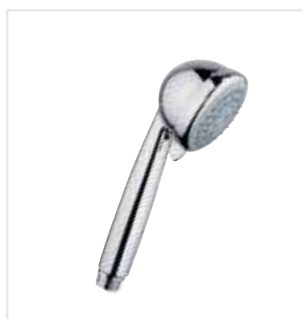

## CALYPSO MULTI

Doccia multigetto ANTICALCARE.  
ANTISCALE multi jet shower.



<b>15340CR</b>	Ø 75 mm	<b>221,00 €</b>
----------------	---------	-----------------



Rampa ACQUARIO

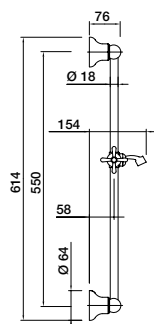

Imballo standard **12 PEZZI**  
Packaging standard **12 PCS**

## TUCANO



rampa TUCANO con doccia PLANET - finitura cromo

Completo saliscendi interamente in ottone con asta  $\varnothing$  25 mm, altezza 70 cm. Flessibile doppia aggraffatura con attacco conico girevole, lunghezza 150 cm.

*Brass sliding railset, tube  $\varnothing$  25 mm, height 70 cm. Double interlock flexible hose with swiveling conical nut, length 150 cm.*



rampa TUCANO CRYSTAL con doccia PLANET e portasapone CRYSTAL - finitura cromo

Con doccia multigetto PLANET anticalcare e portasapone CRYSTAL.

*With antiscaling multi jet PLANET shower and soap shelf CRYSTAL.*

**2046062VT** con portasapone **215,00 €**





Rampa TUCANO

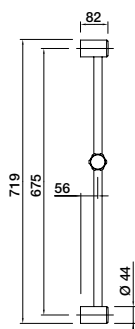

Imballo standard 12 PEZZI  
Packaging standard 12 PCS

+



### PLANET

Doccia multigetto ANTICALCARE.  
ANTISCALE multi jet shower.



**20460CR** Ø 104 mm **170,00 €**

+



### SMALL MULTI Ø 100

Doccia multigetto ANTICALCARE.  
ANTISCALE multi jet shower.



**20661CR** Ø 100 mm **185,00 €**  
**20661VO** Ø 100 mm **250,00 €**  
**20661VR** Ø 100 mm **250,00 €**  
**20661OR** Ø 100 mm **250,00 €**

+

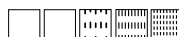
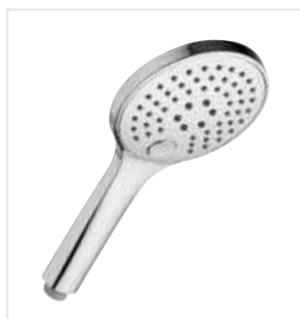

### SOANA

Doccia multigetto ANTICALCARE  
con pulsante tutta cromata.  
ANTISCALE multi jet shower  
with button all chromed.



**20635CR** Ø 105 mm **192,00 €**

+



### SMALL MULTI Ø 80

Doccia multigetto ANTICALCARE.  
ANTISCALE multi jet shower.



**20066CR** Ø 80 mm **167,00 €**

## SIRIO



rampa SIRIO con doccia LUNA - finitura cromo

Immagine a titolo esemplificativo \_ Image as an example

Completo saliscendi in ABS con asta in ottone Ø 25 mm, altezza 80 cm. Flessibile doppia aggraffatura con attacco conico girevole, lunghezza 150 cm.

*Sliding railset in chrome-plated ABS with brass tube Ø 25 mm, height 80 cm. Double interlock flexible hose with swiveling conical nut, 150 cm long.*

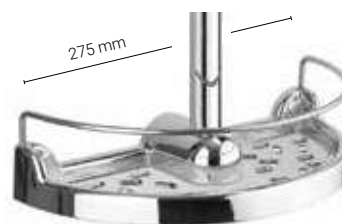

Base porta oggetti integrata e brevettata con piattino.  
*Integrated soap dish patented with dish.*





Rampa SIRIO

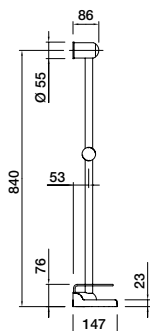

+

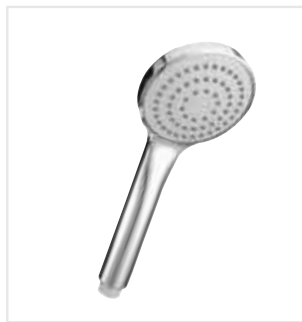

### PIUMA

Doccia monogetto ANTICALCARE.  
ANTISCALE single jet shower.



**10133CR**    Ø 95 mm    **100,00 €**

+



### JOKER

Doccia multigetto ANTICALCARE.  
ANTISCALE multi jet shower.



**10434CR**    Ø 82 mm    **110,50 €**

+



### LUNA

Doccia multigetto ANTICALCARE.  
ANTISCALE multi jet shower.



**10410CR**    Ø 100 mm    **118,00 €**



Imballo standard **12 PEZZI**  
Packaging standard **12 PCS**

## GIOVE



rampa GIOVE con doccia SPRING MULTI - finitura cromo

Completo saliscendi in ABS con asta in ottone Ø 25 mm, altezza 70 cm. Flessibile doppia aggraffatura con attacco conico girevole, lunghezza 150 cm. Distanziale per piastrelle.

*Sliding railset in chrome-plated ABS with brass tube Ø 25 mm, height 70 cm, with soap dish. Double interlock flexible hose with swiveling conical nut, 150 cm long. Spacer for tile.*



rampa GIOVE CRYSTAL con doccia SPRING MULTI e portasapone CRYSTAL - finitura cromo

Con doccia multigetto SPRING MULTI ANTICALCARE e portasapone **CRYSTAL**.

*With ANTISCALE multi jet SPRING MULTI shower and soap shelf **CRYSTAL**.*

**2740360VT**

**113,50 €**



+

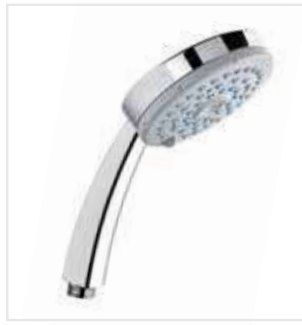

### PLANET

Doccia multigetto ANTICALCARE.  
ANTISCALE multi jet shower.

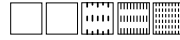

**27460CR**    Ø 104 mm    **97,50 €**

+



### SMALL MONO

Doccia monogetto ANTICALCARE.  
ANTISCALE single jet shower.



**27033CR**    Ø 80 mm    **82,50 €**

+

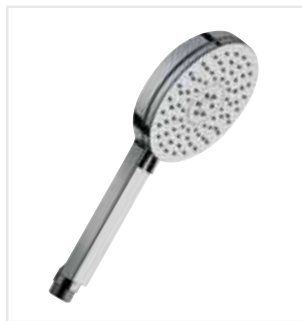

### SPRING MULTI

Doccia multigetto ANTICALCARE.  
ANTISCALE multi jet shower.

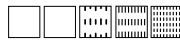

**27403CR**    Ø 80 mm    **101,00 €**



Rampa GIOVE

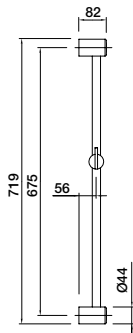

Imballo standard 12 PEZZI  
Packaging standard 12 PCS

## DELFINO



rampa DELFINO con doccia ARIES - finitura cromo

Completo saliscendi in ABS con asta in ottone Ø 25 mm, altezza 60 cm. Flessibile doppia aggraffatura con attacco conico girevole, lunghezza 150 cm.

*Sliding railset in chrome-plated ABS with brass tube Ø 25 mm, height 60 cm. Double interlock flexible hose with conical nut, 150 cm long. Soap dish en chrome-plated ABS.*





Rampa DELFINO

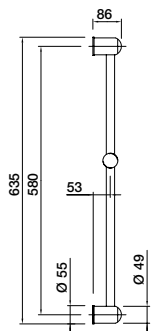

Imballo standard **12 PEZZI**  
Packaging standard **12 PCS**

+



### JOLLY

Doccia monogetto ANTICALCARE.  
*ANTISCALE single jet shower.*



**11020CR** Ø 70 mm **62,00 €**

+

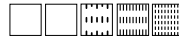

### ARIES

Doccia multigetto ANTICALCARE.  
*ANTISCALE multi jet shower.*



**11360CR** Ø 75 mm **81,00 €**

+

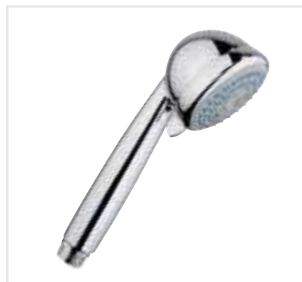

### CALYPSO MULTI

Doccia multigetto ABS  
ANTICALCARE.  
*ANTISCALE multi jet ABS shower.*



**11340CR** Ø 75 mm **81,00 €**

+



### LUNA

Doccia multigetto ANTICALCARE.  
*ANTISCALE multi jet shower.*



**11410CR** Ø 100 mm **86,00 €**

+



### ABIS

Doccia multigetto ANTICALCARE.  
*ANTISCALE multi jet shower.*



**11443CR** Ø 140 mm **111,00 €**

## AIRONE



### VERSIONE AD ANGOLO CORNER VERSION



rampa AIRONE con doccia LUNA e portasapone CRYSTAL - finitura cromo

Completo saliscendi in ABS con asta in ottone Ø 25 mm, altezza 90 cm.  
Flessibile doppia aggraffatura con attacco conico girevole, lunghezza 150 cm.

*Sliding railset in chrome-plated ABS  
with brass tube Ø 25 mm, height 90 cm.  
Double interlock flexible hose with swiveling  
conical nut, length 150 cm.*

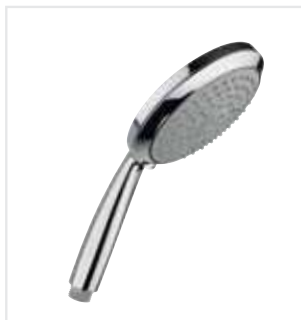

+

**ABIS**

Doccia multigetto ANTICALCARE.  
ANTISCALE multi jet shower.



**26445CR** Ø 140 mm **172,00 €**

**26445CRANG** Ø 140 mm **178,00 €**

+

**LUNA**

Doccia multigetto ANTICALCARE.  
ANTISCALE multi jet shower.



**26410CR** Ø 100 mm **173,00 €**

**26410CRANG** Ø 100 mm **178,00 €**

+

**AIR WATER Ø 130**

Doccia monogetto a  
miscelazione aria/acqua  
Single jet mixing air/water shower



**26585CR** Ø 130 mm **180,00 €**

**26585CRANG** Ø 130 mm **185,00 €**

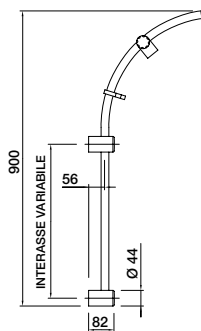





Rampa **AIRONE**

Imballo standard **12 PEZZI**  
Packaging standard **12 PCS**

# DOCCE

## SHOWERS

FINITURE SPECIALI SU RICHIESTA:  
SPECIAL FINISHING ON REQUEST:

-  **OR** Oro | Gold
-  **VO** Vecchio Ottone | Old Brass
-  **VR** Vecchio Rame | Old Copper
-  **NS** Nickel Spazzolato | Satin Nickel
-  **BS** Acciaio Spazzolato | Brushed Stainless Steel
-  **NE** Nero | Black
-  **BI** Bianco | White

Sugli articoli in finitura speciale si potrebbero presentare delle imperfezioni, dovute al tipo di lavorazione.  
*Please kindly note that on items in special finishing you may have imperfections due to the type of machining.*





DOCCE



# DOCCE

## SHOWERS

SEZ.		PAG.	SEZ.		PAG.
	<b>Monogetto _ Single jet</b>			<b>Cucina _ Kitchen</b>	
○	SMALL MONO	222	○	CAPRI ANTICALCARE	229
○	JOLLY	222	○	ISCHIA	229
○	PIUMA	222	○	CAPRI	229
○	CIGAR	222	○	FLUTE	229
○	STICK	222	○	SWEET	229
□	CUBE	222	○	PROFESSIONAL	229
○	SOFT MONO 100	223		<b>Shut off</b>	
○	SOFT MONO 130	223	○	TOCE	230
○	ANTIQUA	223	○	RENO	230
○	BELLE EPOQUE	223	○	NILO	230
○	MINI TONDA	223	○	ARNO	230
□	MINI QUADRA	223	○	TEVERE	230
□	MINI RETTANGOLARE	224	○	PO'	230
○	AIR WATER 100	224	○	MISSISSIPPI	231
○	AIR WATER 130	224	○	MISSOURI	231
	<b>Multigetto _ Multi jet</b>		□	TAMIGI	231
○	SMALL MULTI 80	225	□	DANUBIO	231
○	SMALL MULTI 100	225		<b>Kit presa acqua _ kit water supply</b>	
○	SMALL MULTI 130	225		KIT PRESE ACQUA	
○	JOKER	225		CON PORTADOCCIA	232
○	JOKER ECO	225		KIT PRESE ACQUA	
○	ARIES	225		ON-OFF CON PORTADOCCIA	234
○	PIUMA MULTI	226		KIT PRESE ACQUA MISCELATRICI	
○	DORA 80 / 100	226		CON PORTADOCCIA	236
○	MIKADO	226			
○	CALYPSO MULTI	226			
○	PLANET	226			
○	LUNA	226			
○	SPRING MULTI	227			
○	SMILE	227			
○	ABIS	227			
○	SOFT MULTI 100	227			
○	SOFT MULTI 130	227			
○	RIPA	227			
○	SOANA	228			



### SMALL MONO

Doccia monogetto  
ANTICALCARE.  
ANTISCALE single jet  
shower.

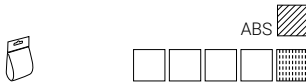
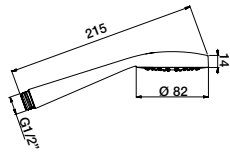

**00033CR** Ø 80 mm 16,70 €  
**00033NE** Ø 80 mm 22,00 €  
**00033BI** Ø 80 mm 22,00 €

\* Finiture speciali su richiesta \_ Special finishing on request

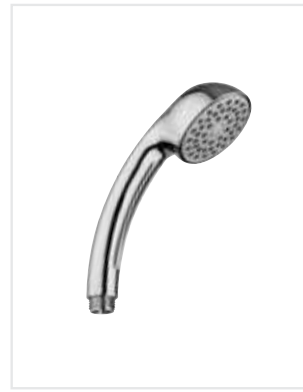

### JOLLY

Doccia monogetto  
ANTICALCARE.  
ANTISCALE single jet  
shower.

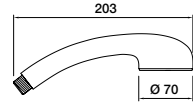

**00020CR** Ø 70 mm 8,00 €

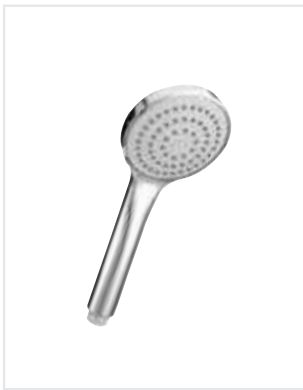

### PIUMA

Doccia monogetto  
ANTICALCARE.  
ANTISCALE single jet  
shower.

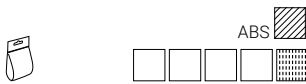
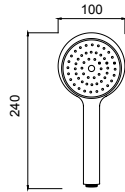

**00133CR1** Ø 100 mm 14,00 €

\* Finiture speciali su richiesta \_ Special finishing on request



### CIGAR

Doccia monogetto  
ANTICALCARE.  
ANTISCALE single jet  
shower.

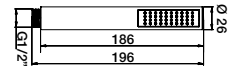

**00141CR** Ø 26 mm 17,00 €  
**00141VO** Ø 26 mm 34,00 €  
**00141VR** Ø 26 mm 34,00 €  
**00141NS** Ø 26 mm 34,00 €  
**00141OR** Ø 26 mm 34,00 €  
**00141NE** Ø 26 mm 34,00 €  
**00141BI** Ø 26 mm 34,00 €

\* Finiture speciali su richiesta \_ Special finishing on request



### STICK

Doccia monogetto  
ANTICALCARE.  
ANTISCALE single jet  
shower.

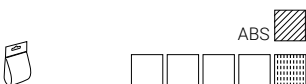
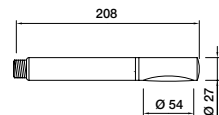

**00140CR** Ø 27 mm 15,50 €

\* Finiture speciali su richiesta \_ Special finishing on request



### CUBE

Doccia monogetto  
ANTICALCARE.  
ANTISCALE single jet  
shower.

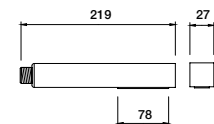

**00261CR** 27x27 mm 27,00 €  
**00261VO** 27x27 mm 46,00 €  
**00261VR** 27x27 mm 46,00 €  
**00261NS** 27x27 mm 46,00 €  
**00261OR** 27x27 mm 46,00 €  
**00261NE** 27x27 mm 46,00 €  
**00261BI** 27x27 mm 46,00 €

\* Finiture speciali su richiesta \_ Special finishing on request

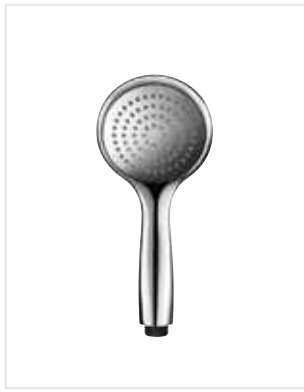

### SOFT MONO 100

Doccia monogetto  
ANTICALCARE.  
ANTISCALE single jet shower.

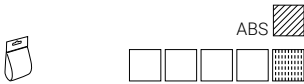
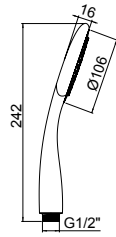

**00581CR** Ø 100 mm **40,00 €**



### SOFT MONO 130

Doccia monogetto  
ANTICALCARE.  
ANTISCALE single jet shower.

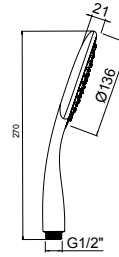

**00586CR** Ø 130 mm **49,00 €**



### ANTIQUA

Doccia monogetto  
in OTTONE.  
BRASS single jet shower.

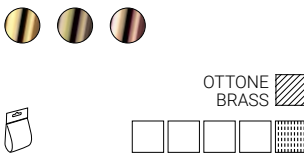
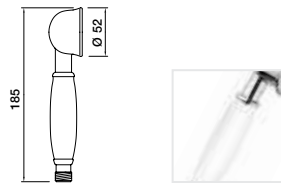

**00180CR** Ø 52 mm **31,00 €**  
**00180OR** Ø 52 mm **48,00 €**  
**00180VO** Ø 52 mm **48,00 €**  
**00180VR** Ø 52 mm **48,00 €**  
**00180CER** Ø 52 mm **57,00 €**  
 Impugnatura ceramica bianca

\* Finiture speciali su richiesta \_ Special finishing on request

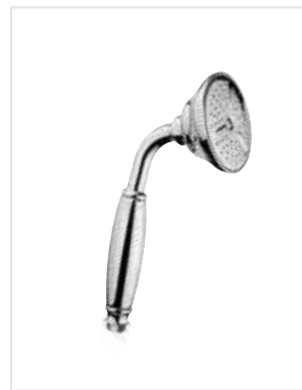

### BELLE EPOQUE

Doccia monogetto  
in OTTONE.  
BRASS single jet shower.

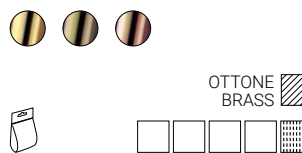
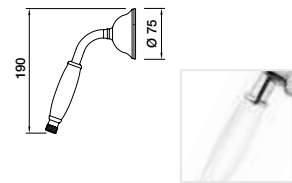

**00190CR** Ø 75 mm **44,00 €**  
**00190CO** Ø 75 mm **68,00 €**  
**00190OR** Ø 75 mm **68,00 €**  
**00190VO** Ø 75 mm **68,00 €**  
**00190VR** Ø 75 mm **68,00 €**  
**00190CER** Ø 75 mm **72,00 €**  
 Impugnatura ceramica bianca

\* Finiture speciali su richiesta \_ Special finishing on request



### MINI TONDA

Doccia monogetto  
ANTICALCARE.  
ANTISCALE single jet shower.

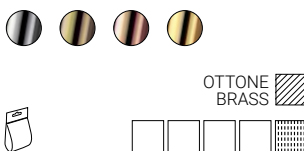
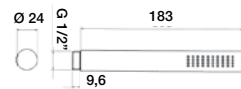

**00241CR** Ø 24 mm **47,00 €**  
**00241ACC** Ø 24 mm **59,00 €**  
**00241ACCSPAZ** Ø 24 mm **78,50 €**  
**00241INS** Ø 24 mm **78,50 €**  
**00241VO** Ø 24 mm **78,50 €**  
**00241VR** Ø 24 mm **78,50 €**  
**00241OR** Ø 24 mm **78,50 €**



### MINI QUADRA

Doccia monogetto  
ANTICALCARE.  
ANTISCALE single jet shower.

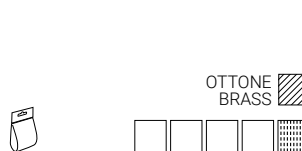

**00200CR** 22x22 mm **72,00 €**



### MINI RETTANGOLARE

Doccia monogetto  
ANTICALCARE.  
ANTISCALE single jet  
shower.

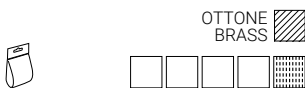
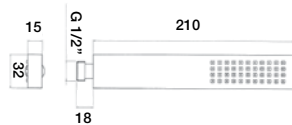

**00260CR** 32x15 mm **88,00 €**



### AIR WATER 100

Doccia a miscelazione  
ARIA/ACQUA.  
Single jet mixing  
AIR/WATER shower.

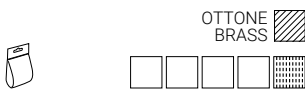
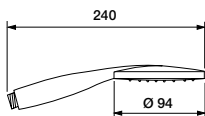

**00580CR** Ø 100 mm **46,00 €**  
**00580NE** Ø 100 mm **69,00 €**  
**00580BI** Ø 100 mm **69,00 €**

\* Finiture speciali su richiesta \_ *Special finishing on request*

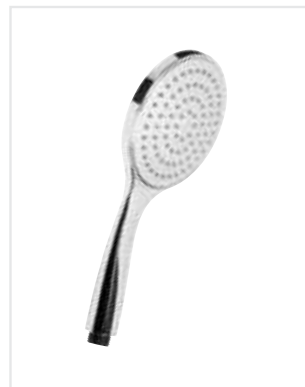

### AIR WATER 130

Doccia a miscelazione  
ARIA/ACQUA.  
Single jet mixing  
AIR/WATER shower.

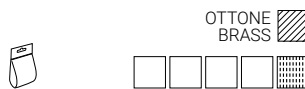
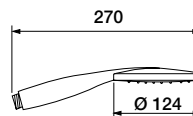

**00585CR** Ø 130 mm **65,00 €**  
**00585NE** Ø 130 mm **84,00 €**  
**00585BI** Ø 130 mm **84,00 €**

\* Finiture speciali su richiesta \_ *Special finishing on request*



### SMALL MULTI 80

Doccia multigetto  
ANTICALCARE.  
ANTISCALE multi jet  
shower.

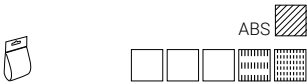
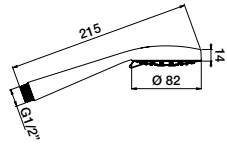

**0066CR** Ø 82 mm 31,00 €



### SMALL MULTI 100

Doccia multigetto  
ANTICALCARE.  
ANTISCALE multi jet  
shower.

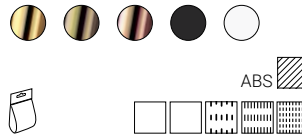
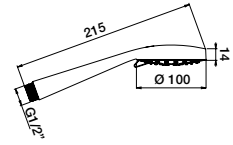

**00661CR** Ø 100 mm 59,00 €  
**00661OR** Ø 100 mm 83,00 €  
**00661VO** Ø 100 mm 83,00 €  
**00661VR** Ø 100 mm 83,00 €  
**00661NE** Ø 100 mm 83,00 €  
**00661BI** Ø 100 mm 83,00 €

\* Finiture speciali su richiesta \_ Special finishing on request



### SMALL MULTI 130

Doccia multigetto  
ANTICALCARE.  
ANTISCALE multi jet  
shower.

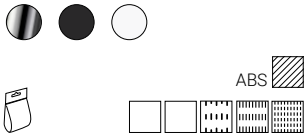
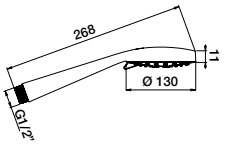

**00662CR** Ø 130 mm 63,50 €  
**00662NS** Ø 130 mm 87,00 €  
**00662NE** Ø 130 mm 87,00 €  
**00662BI** Ø 130 mm 87,00 €

\* Finiture speciali su richiesta \_ Special finishing on request



### JOKER

Doccia multigetto  
ANTICALCARE.  
ANTISCALE multi jet  
shower.

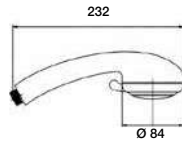

**00434CR** Ø 84 mm 23,00 €



### JOKER ECO

Doccia multigetto  
ANTICALCARE.  
ANTISCALE multi jet  
shower.

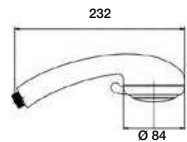

**00435CR** Ø 84 mm 19,00 €

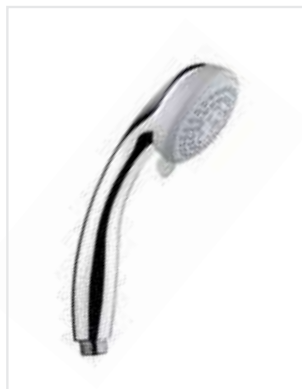

### ARIES

Doccia multigetto  
ANTICALCARE.  
ANTISCALE multi jet  
shower.

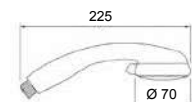

**00360CR** Ø 70 mm 27,00 €



### PIUMA MULTI

Doccia multigetto  
ANTICALCARE.  
ANTISCALE multi jet  
shower.

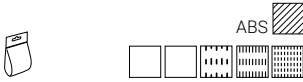
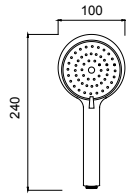

**00134CR** Ø 100 mm 18,60€

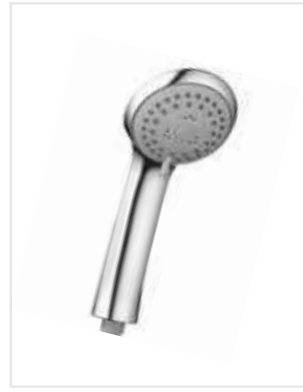

### DORA 80 / 100

Doccia multigetto  
ANTICALCARE.  
ANTISCALE multi jet  
shower.

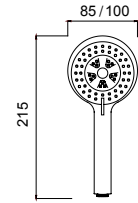

**00315CR** Ø 85 mm 14,00 €

**00316CR** Ø 100 mm 19,80 €



### MIKADO

Doccia multigetto  
ANTICALCARE.  
ANTISCALE multi jet  
shower.

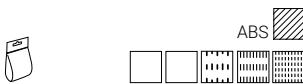
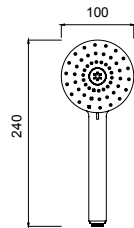

**00201CR** Ø 100 mm 28,00 €

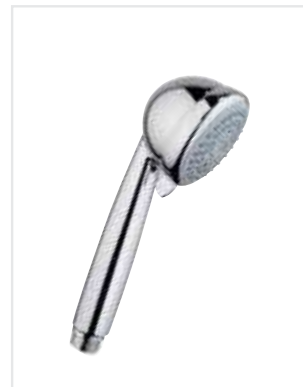

### CALYPSO MULTI

Doccia multigetto  
ANTICALCARE.  
ANTISCALE multi jet  
shower.

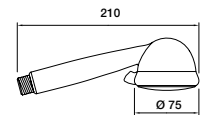

**00340CR** Ø 75 mm 27,00 €

\* Finiture speciali su richiesta \_ Special finishing on request



### PLANET

Doccia multigetto  
ANTICALCARE.  
ANTISCALE multi jet  
shower.

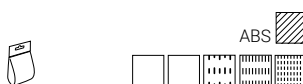
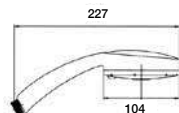

**00460CR** Ø 104 mm 32,00 €



### LUNA

Doccia multigetto  
ANTICALCARE.  
ANTISCALE multi jet  
shower.

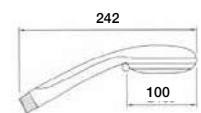

**00410CR** Ø 100 mm 32,00 €



### SPRING MULTI

Doccia multigetto  
ANTICALCARE.  
ANTISCALE multi jet  
shower.

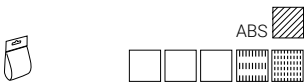
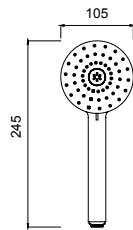

**00403CR** Ø 105 mm **35,00 €**

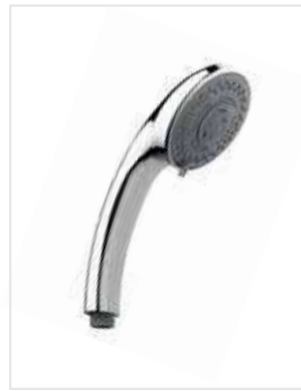

### SMILE

Doccia multigetto  
ANTICALCARE.  
ANTISCALE multi jet  
shower.

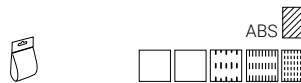
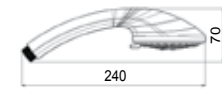

**00402CR** Ø 95 mm **32,50 €**



### ABIS

Doccia multigetto  
ANTICALCARE.  
ANTISCALE multi jet  
shower.

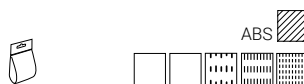
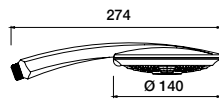

**00445CR105** Ø 105 mm **41,00 €**  
**00445CR140** Ø 140 mm **57,00 €**

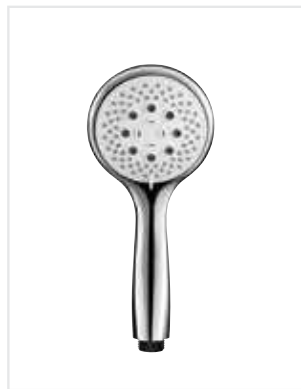

### SOFT MULTI 100

Doccia multigetto  
ANTICALCARE.  
ANTISCALE multi jet  
shower.

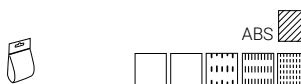
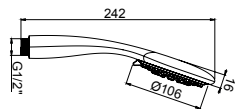

**00663CR** Ø 100 mm **58,00 €**  
**00663NS** Ø 100 mm **77,00 €**



### SOFT MULTI 130

Doccia multigetto  
ANTICALCARE.  
ANTISCALE multi jet  
shower.

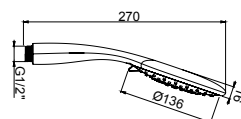

**00664CR** Ø 130 mm **64,00 €**  
**00664NS** Ø 130 mm **84,00 €**



### RIPA

Doccia multigetto  
ANTICALCARE con  
pulsante tutta cromata.  
ANTISCALE multi jet shower  
with button all chromed.

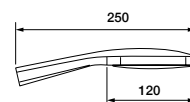

**00535CR** Ø 250x120 mm **56,00 €**



## SOANA

Doccia multigetto  
ANTICALCARE con  
pulsante tutta cromata.  
*ANTISCALE multi jet shower  
with button all chromed.*

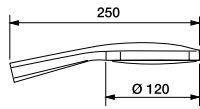

**00635CR** Ø 120 mm 56,00 €







### TOCE

SHUT-OFF a pulsante.  
SHUT-OFF hand spray.

Doccia con pulsante per erogazione acqua.  
Hand spray with push button.

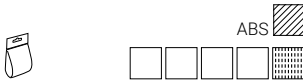
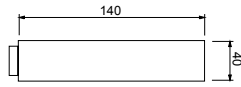

**00999CR** 16,00 €

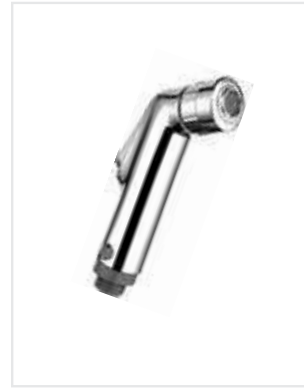

### RENO

SHUT-OFF a pulsante due getti  
per WC e igiene personale.  
SHUT-OFF hand spray two-jets  
for WC and personal hygiene.

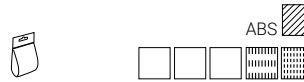
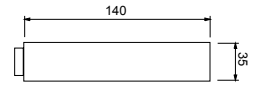

**00876CR** 23,50 €



### NILO

SHUT-OFF a pulsante  
due getti.  
SHUT-OFF hand spray  
two-jets.

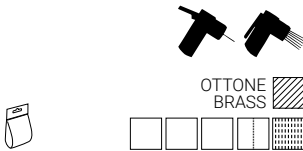
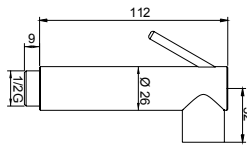

**EJ2514** 104,00 €



### ARNO

SHUT-OFF a pulsante  
getto bidet.  
SHUT-OFF hand spray  
with single lever bidet jet.

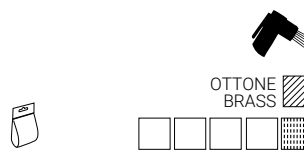
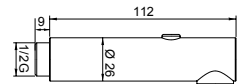

**SO1417** 78,00 €



### TEVERE

SHUT-OFF a pulsante.  
SHUT-OFF hand spray.

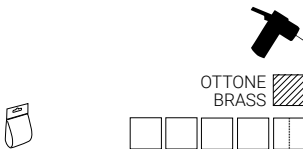
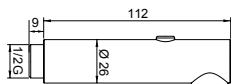

**ID1416** 78,00 €



### PO'

SHUT-OFF a pulsante  
con aeratore.  
SHUT-OFF hand spray  
with aerator.

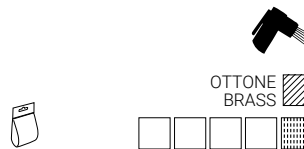
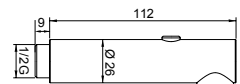

**SO1418** 78,00 €



### MISSISSIPPI

SHUT-OFF a pulsante  
getto bidet.  
SHUT-OFF hand spray  
with single lever bidet jet.

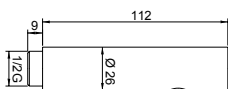

OTTONE  
BRASS



SO1413

78,00 €



### MISSOURI

SHUT-OFF a pulsante.  
SHUT-OFF hand spray.

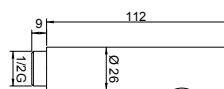

OTTONE  
BRASS



ID1412

78,00 €



### TAMIGI

SHUT-OFF a pulsante  
getto bidet.  
SHUT-OFF hand spray  
with single lever bidet jet.

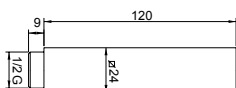

OTTONE  
BRASS



SO1426

94,00 €



### DANUBIO

SHUT-OFF a pulsante.  
SHUT-OFF hand spray.

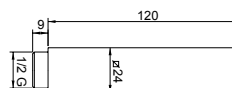

OTTONE  
BRASS



ID1425

94,00 €



## KIT PRESE ACQUA

con portadoccia



presa acqua PAPDOC52876 - finitura cromo

Kit presa acqua OPEN/CLOSE in ottone cromato con portadoccia e rosone Ø 55 mm 1/2" M x 1/2" M. Completa di doccia RENO con flessibile doppia aggraffatura con attacco conico girevole, lunghezza 150 cm.

Shower kit including brass water supply with OPEN/CLOSE system, shower holder and rosette Ø 55 mm, ABS shut off RENO and double interlock flexible hose with swivel conical connection, length 150 cm.





CIGAR abs		<b>PAPDT52141</b> 83,50 €	-	<b>PAPDOC52141</b> 137,00 €
CUBE abs		-	<b>PAPDQ52261</b> 102,00 €	<b>PAPDOC52261</b> 146,00 €
MINI TONDA ottone - brass		<b>PAPDT52241</b> 114,00 €	-	<b>PAPDOC52241</b> 166,00 €
MINI QUADRA ottone - brass		-	<b>PAPDQ52200</b> 151,00 €	<b>PAPDOC52200</b> 191,00 €
TOCE abs		-	-	<b>PAPDOC52999</b> 135,00 €
RENO abs		-	-	<b>PAPDOC52876</b> 140,00 €

### KIT PRESA ACQUA CON MISCELATORE + RENO (IN ABS 2 GETTI)

**52876CRK** Cromo | Chrome **160,00 €**



Kit presa acqua in ottone cromato a miscelazione, con portadoccia. Completa di doccia RENO in ABS con flessibile doppia aggiratura con attacco conico girevole, lunghezza 100 cm.

*Shower kit water supply in chromed brass with on/off system. Along with wall bracket handshower. abs shut off reno with double interlock flexible hose with swivel conical connection, length 100 cm.*



**PAPDT52** Cromo | Chrome

Preso acqua Ø 32 mm a muro in ottone cromato con portadoccia e rosone Ø 50 mm 1/2" M x 1/2" M.

*Chromed brass water supply Ø 32 mm with shower holder and rosette Ø 50 mm 1/2" M x 1/2" M.*



**PAPDQ52** Cromo | Chrome

Preso acqua quadra 25x25 a muro in ottone cromato con portadoccia 1/2" M x 1/2" M.

*Chromed brass square 25x25 wall water supply with carry shower 1/2" M x 1/2" M.*



**PAPDOC52** Cromo | Chrome

Preso acqua OPEN/CLOSE in ottone cromato con vitone a disco ceramico apertura e chiusura acqua.

*Chromed brass water supply OPEN/CLOSE with ceramic disc for open/close water.*



## KIT PRESE ACQUA ON/OFF

con portadoccia



presa acqua ON/OFF PAPDOF308417 - finitura cromo

 OTTONE  
BRASS

Kit presa acqua tonda ON/OFF in ottone cromato con portadoccia e chiusura di sicurezza, completo di doccia ARNO con flessibile doppia aggraffatura con attacco conico girevole, lunghezza 120 cm. Sistema di apertura/chiusura "click" con pressore.

*Shower kit water supply in chromed brass with shower holder, ON/OFF system, handshower ARNO and double interlock flexible hose with swivel conical connection. Length 120 cm.*

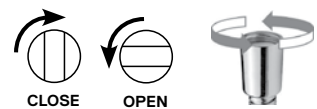



NILO ottone - brass 		<b>PAPDOF308514</b> 226,00 €	<b>PAPDOF407514</b> 238,00 €
ARNO ottone - brass 		<b>PAPDOF308417</b> 201,00 €	<b>PAPDOF407417</b> 212,00 €
TEVERE ottone - brass 		<b>PAPDOF308416</b> 201,00 €	<b>PAPDOF407416</b> 212,00 €
PO' ottone - brass 		<b>PAPDOF308418</b> 201,00 €	<b>PAPDOF407418</b> 212,00 €
MISSISSIPI ottone - brass 		<b>PAPDOF308413</b> 201,00 €	-
MISSOURI ottone - brass 		<b>PAPDOF308412</b> 201,00 €	-
TAMIGI ottone - brass 		-	<b>PAPDOF407426</b> 227,00 €
DANUBIO ottone - brass 		-	<b>PAPDOF407425</b> 227,00 €

\* Finiture speciali su richiesta \_ *Special finishing on request*

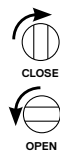

**PAPDOF308**

Cromo | Chrome

Presa acqua ON/OFF tonda in ottone cromato con portadoccia e chiusura di sicurezza. Sistema di apertura/chiusura "click" con pressore.

*ON/OFF round chromed brass water supply with shower holder and safety closure. Opening/closing system "click" with ball plunger.*

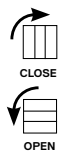

**PAPDOF407**

Cromo | Chrome

Presa acqua ON/OFF quadra in ottone cromato con portadoccia e chiusura di sicurezza. Sistema di apertura/chiusura "click" con pressore.

*ON/OFF square chromed brass water supply with shower holder and safety closure. Opening/closing system "click" with ball plunger.*



# KIT PRESE ACQUA MISCELATRICI

con portadoccia



presa acqua **PAMIS800417** - finitura cromo

 OTTONE  
BRASS

Kit presa acqua in ottone cromato a miscelazione, con portadoccia. Completa di doccia ARNO con flessibile doppia aggraffatura con attacco conico girevole, lunghezza 120 cm.

*Shower kit water supply in chromed brass with shower holder and mixer, handshower ARNO and double interlock flexible hose with swivel conical connection. Length 120 cm.*

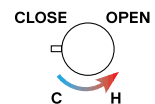



NILO ottone - brass  	<b>PAMIS800514</b> 520,00 €	<b>PAMIS900514</b> 626,00 €
ARNO ottone - brass  	<b>PAMIS800417</b> 495,00 €	<b>PAMIS900417</b> 600,00 €
PO' ottone - brass  	<b>PAMIS800418</b> 495,00 €	<b>PAMIS900418</b> 600,00 €
MISSISSIPPI ottone - brass  	<b>PAMIS800413</b> 495,00 €	-
TAMIGI ottone - brass  	-	<b>PAMIS900426</b> 616,00 €

\* Finiture speciali su richiesta \_ *Special finishing on request*

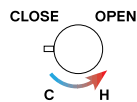

**PAMIS800** Cromo | Chrome

Miscelatore tondo da incasso per doccette in ottone cromato.

*Round concealed mixer for handshowers in chromed brass.*

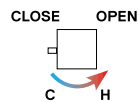

**PAMIS900** Cromo | Chrome

Miscelatore quadro da incasso per doccette in ottone cromato.

*Square concealed mixer for handshowers in chromed brass.*



# RUBINETTI E ACCESSORI

## TAPS AND ACCESSORIES

	PAG.
RUBINETTI ABBINABILI A COLONNE, SALISCENDI, MONOCOMANDI E TERMOSTATICI AVAILABLE TAPS FOR COLUMNS, SLIDING BARS MIXER AND THERMOSTATIC MIXER	240
CARTUCCE CARTRIDGES	244
PLACCHETTE RICAMBIO PLAQUES DE RECHANGE	245
RUBINETTERIA TAPS	246
AERATORI AERATORS	249
FLESSIBILI FLEXIBLES	250
PORTASAPONE SOAP DISH	252
ALTRI ACCESSORI OTHER ACCESSORIES	253
SGABELLI DOCCIA SHOWER STOOL	258
PORTAOGGETTI PER BOX DOCCIA HANGING SHOWER CADDY	259







## INCASSO TERMOSTATICO QUADRO

Miscelatore termostatico da incasso 1-2-3 vie.  
Built-in thermostatic mixer 1-2-3 ways.

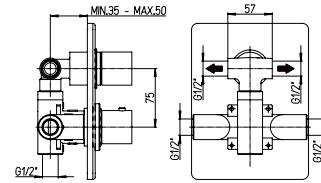
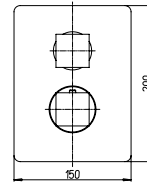

<b>66119CRT1V</b>	termostatico 1 via   thermostatic 1 way	<b>490,00 €</b>
<b>66119CRT2V</b>	termostatico 2 vie   thermostatic 2 ways	<b>650,00 €</b>
<b>66119CRT3V</b>	termostatico 3 vie   thermostatic 3 ways	<b>660,00 €</b>

## INCASSO MISCELATORE MONOCOMANDO QUADRO



### 66119CRM1V

Miscelatore monocomando da incasso 1 via.  
Built-in mixer 1 way.

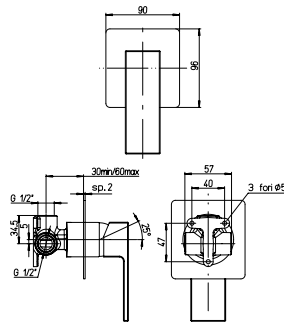

<b>66119CRM1V</b>	monocomando 1 via   built-in mixer 1 way	<b>144,00 €</b>
-------------------	--	-----------------



### 66119CRM2V

Miscelatore monocomando da incasso 2 vie.  
Built-in mixer 2 ways.

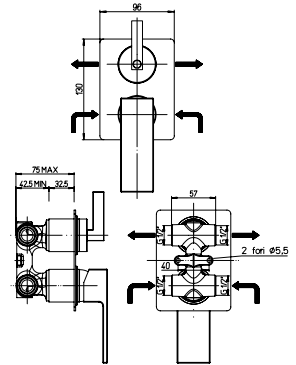

<b>66119CRM2V</b>	monocomando 2 vie   built-in mixer 2 ways	<b>290,00 €</b>
-------------------	---	-----------------



### 66119CRM3V

Miscelatore monocomando da incasso 3 vie.  
Built-in mixer 3 ways.

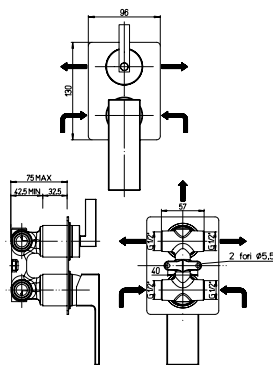

<b>66119CRM3V</b>	monocomando 3 vie   built-in mixer 3 ways	<b>298,00 €</b>
-------------------	---	-----------------





### 66133CRS

Gruppo monocomando esterno per saliscendi.  
Interasse 150 mm.  
*Mixer for sliding bar.*  
*Interaxis distance 150 mm.*



### 66134CR

Gruppo monocomando moderno da fusione per colonna. Interasse 150 mm.  
*Mixer for modern columns.*  
*Interaxis distance 150 mm.*



125,00 €



192,00 €

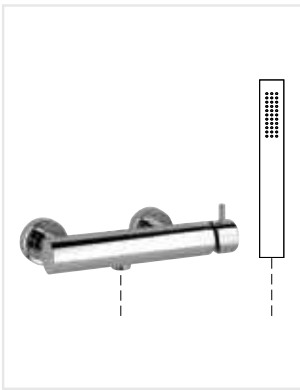

### 66134CRS

Gruppo monocomando moderno da fusione per saliscendi. Interasse 150 mm.  
*Mixer for modern sliding bar.*  
*Interaxis distance 150 mm.*



### 66135CR

Gruppo monocomando esterno per colonne. Interasse 150 mm.  
*Mixer for columns*  
*Interaxis distance 150 mm.*



192,00 €



126,00 €



### 66135CRS

Gruppo monocomando esterno per saliscendi. Interasse 150 mm.  
*Mixer for sliding bar.*  
*Interaxis distance 150 mm.*



### 66131CR

Monocomando quadro per colonna. Interasse 150 mm.  
*Square mixer for columns.*  
*Interaxis distance 150 mm.*



126,00 €



318,00 €

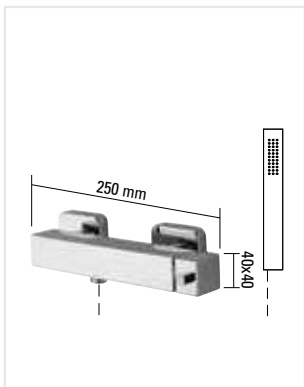

### 66131CRS



Monocomando quadro per saliscendi.  
Interasse 150 mm.  
*Square mixer for sliding bar.*  
*Interaxis distance 150 mm.*



### 66400CR



Termostatico MINIMAL con deviatore integrato tondo per colonna.  
Interasse 150 mm.  
*MINIMAL thermostatic mixer with integrated diverter for column.*  
*Interaxis distance 150 mm.*



318,00 €



232,00 €

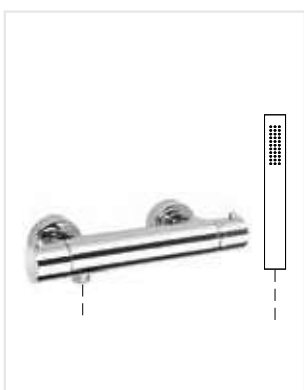

### 66401CRINF



Termostatico MINIMAL con uscita inferiore per saliscendi.  
Interasse 150 mm.  
*MINIMAL thermostatic mixer with lower output for sliding bar.*  
*Interaxis distance 150 mm.*



### 66100CR



Termostatico tondo da barra con deviatore integrato per colonna. Interasse 150 mm.  
*Round thermostatic mixer with integrated diverter for columns.*  
*Interaxis distance 150 mm.*



232,00 €



316,00 €



### 66300CR



Termostatico quadro da barra con deviatore integrato per colonna. Interasse 150 mm.  
*Square thermostatic mixer with integrated diverter for columns.*  
*Interaxis distance 150 mm.*



### 66500CR



Termostatico quadro MINIMAL da barra con deviatore integrato per colonna. Interasse 150 mm.  
*MINIMAL square thermostatic mixer with integrated diverter for columns.*  
*Interaxis distance 150 mm.*



430,00 €



370,00 €



Corpo termostatico tornito da barra di ottone cromato di nostra produzione. Facilità e semplicità di sostituzione cartuccia.  
 Si raccomanda di estrarre la cartuccia con la manopola montata per evitare di perdere la taratura.  
 Chromed thermostatic body, brass bar turned, of our production. Easy replacement of the cartridge.



### 65300CRT

Cartuccia termostatica completa di maniglia cromata.  
*Thermostatic valve with chrome handle.*

80,00 €

### 65300CRD

Cartuccia deviatrice completa di maniglia cromata.  
*Diverter valve with chrome handle.*

80,00 €

### 65006

Cartuccia deviatrice in ottone (senza maniglia).  
*Brass diverter valve (without handle).*

46,00 €



### 65301CRT

Cartuccia termostatica minimal completa di maniglia cromata.  
*Thermostatic valve with chrome handle.*

80,00 €

### 65301CRD

Cartuccia deviatrice minimal completa di maniglia cromata.  
*Minimal diverter valve with chrome handle.*

80,00 €

### 65006

Cartuccia deviatrice in ottone (senza maniglia).  
*Brass diverter valve (without handle).*

46,00 €



### 65302CRT

Cartuccia termostatica completa di maniglia in metallo cromata.  
*Thermostatic valve with chrome handle.*

92,00 €

### 65302CRD

Cartuccia deviatrice completa di maniglia in metallo cromata.  
*Diverter valve with chrome handle.*

92,00 €

### 65006

Cartuccia deviatrice in ottone (senza maniglia).  
*Brass diverter valve (without handle).*

46,00 €



### 65304CRT

Cartuccia termostatica minimal completa di maniglia in metallo cromata.  
*Thermostatic valve with chrome handle.*

80,00 €

### 65304CRD

Cartuccia deviatrice minimal completa di maniglia in metallo cromata.  
*Minimal diverter valve with chrome handle.*

80,00 €

### 65007

Cartuccia deviatrice in ABS (senza maniglia).  
*ABS diverter valve (without handle).*

38,00 €



### 65250

Ricambio cartuccia monocomando Ø35 (bassa o alta).  
*Spare parts single lever Ø35 (low or high).*

26,00 €

### 65251

Ricambio cartuccia monocomando Ø40 (bassa o alta).  
*Spare parts single lever Ø40 (low or high).*

37,00 €

### MANTERABS

Ricambio solo manopola in ABS | *ABS spare parts only handle* 14,00 €

### MANTERMET

Ricambio solo manopola in metallo | *Metal spare parts only handle* 23,00 €

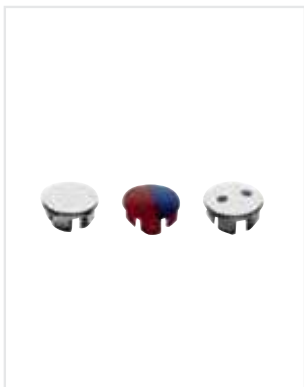

 30 Pcs.

### PL09MIX

Confezione mix placchette d.8mm in un sacchetto contenente:  
pz 10 rosso/blu, pz 10 cromo, pz 10 cromo con punto rosso/blu.  
*Mix plaquettes box d.8mm with:  
10 pieces red/blue, 10 pieces chrome,  
10 pieces with red/blue point.*

### PL06MIX

Confezione mix placchette d.6mm in un sacchetto contenente:  
pz 10 rosso/blu, pz 10 cromo, pz 10 cromo con punto rosso/blu.  
*Mix plaquettes box d.6mm with:  
10 pieces red/blue, 10 pieces chrome,  
10 pieces with red/blue point.*

### PL65MIX

Confezione mix placchette d.6,5mm in un sacchetto contenente:  
pz 10 rosso/blu, pz 10 cromo, pz 10 cromo con punto rosso/blu.  
*Mix plaquettes box d.6.6mm with:  
10 pieces red/blue, 10 pieces chrome,  
10 pieces with red/blue point.*

<b>PL09MIX</b>	testa Ø 9 - sotto Ø 7,8 conf. pz 30	<b>28,00 €</b>
<b>PL06MIX</b>	testa Ø 6 - sotto Ø 5,7 conf. pz 30	<b>28,00 €</b>
<b>PL65MIX</b>	testa Ø 7 - sotto Ø 6,5 conf. pz 30	<b>28,00 €</b>



 24 Pcs.

Ghiera in ABS cromata completa di inserto hot/cold.  
*Ring in ABS chromed complete of hot/cold insert.*

<b>PL18MIX</b>	Ø 18 fil. 3/8 conf. pz 24	<b>34,00 €</b>
<b>PL20MIX</b>	Ø 20 fil. 3/8 conf. pz 24	<b>34,00 €</b>
<b>PL22MIX</b>	Ø 22 fil. 3/8 conf. pz 24	<b>34,00 €</b>



### LAVABO CLASSICO

Miscelatore monocomando lavabo con scarico.  
*Single lever wash basin mixer with pop-up waste.*

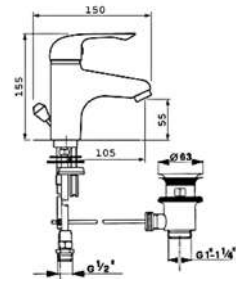

**67LAVCL** 178,00 €

\* Finiture speciali su richiesta \_ *Special finishing on request*



### BIDET CLASSICO

Miscelatore monocomando bidet con scarico.  
*Single lever bidet mixer with pop-up waste.*

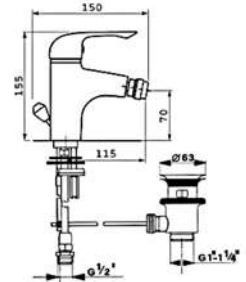

**67BIDCL** 178,00 €

\* Finiture speciali su richiesta \_ *Special finishing on request*



### 67CUC

Monocomando per lavello in abs con doccia estraibile a due getti, bocca girevole.  
*Abs single lever sink with extractable two-jet hand shower, swiveling spout.*

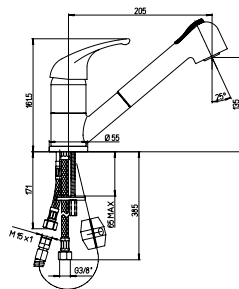

**67CUC** 110,00 €

\* Finiture speciali su richiesta \_ *Special finishing on request*



### 67CL

Monocomando per lavello corpo Ø 50 mm.  
*Single lever sink, body Ø 50 mm.*

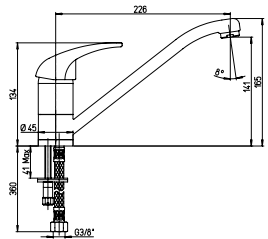

**67CL** 115,00 €

\* Finiture speciali su richiesta \_ *Special finishing on request*



### 67CLES

Monocomando per lavello con doccia estraibile e leva clinica, corpo Ø 50 mm.  
*Single lever sink with extractable hand shower and clinical lever, body Ø 50 mm.*

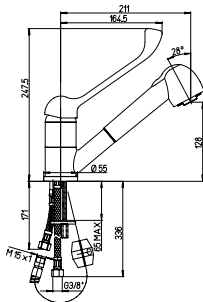

**67CLES** 130,00 €

\* Finiture speciali su richiesta \_ *Special finishing on request*





### LAVABO MINIMAL

Miscelatore monocomando lavabo con scarico.  
*Single-lever wash basin mixer with pop-up waste.*

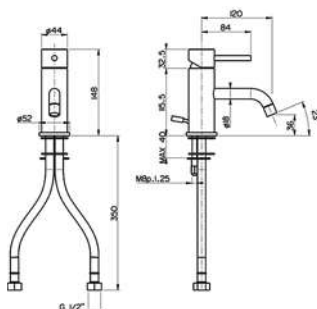

**67LAVMIN** 171,00 €

\* Finiture speciali su richiesta \_ *Special finishing on request*



### BIDET MINIMAL

Miscelatore monocomando bidet con scarico.  
*Single-lever bidet mixer with pop-up waste.*

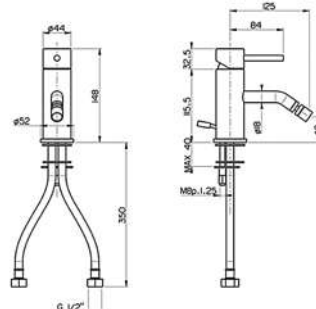

**67BIDMIN** 171,00 €

\* Finiture speciali su richiesta \_ *Special finishing on request*



### LAVABO QUADRO

Miscelatore monocomando lavabo quadro con scarico.  
*Square single lever wash basin mixer with pop-up waste.*

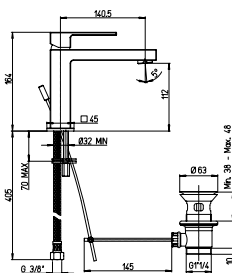

**67LAVQU** 190,00 €

\* Finiture speciali su richiesta \_ *Special finishing on request*



### BIDET QUADRO

Miscelatore monocomando bidet quadro con scarico.  
*Square single lever bidet mixer with pop-up waste.*

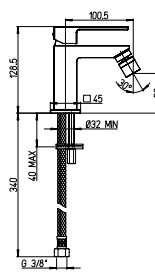

**67BIDQU** 190,00 €

\* Finiture speciali su richiesta \_ *Special finishing on request*





### PERLATOR

Cartuccia aeratore con guarnizione.  
 Ricambio cartuccia per perlator.  
*Aerator cartridge with gasket.*



<b>58000</b>	M 24 x 1	250 Pcs.	<b>1,85 € cad</b>
<b>58002</b>	F 22 x 1	250 Pcs.	<b>1,85 € cad</b>



### PERLATOR

Areatore a norma.  
*Aerator international approvals.*



<b>58010CR</b>	M 24 x 1	10 Pcs.	<b>2,30 € cad</b>
<b>58012CR</b>	F 22 x 1	10 Pcs.	<b>2,30 € cad</b>
<b>58014CR</b>	M 28 x 1	5 Pcs.	<b>5,20 € cad</b>



### PERLATOR + HONEYCOMB

Areatore anticalcare a risparmio d'acqua 8 lt. a 3 Bar.  
*Aerator with anti-liming and water saving technology 8 lt. at 3 Bar.*



<b>58020CR</b>	M 24 x 1	10 Pcs.	<b>5,20 € cad</b>
<b>58022CR</b>	F 22 x 1	10 Pcs.	<b>5,20 € cad</b>



### CHIAVE DI MONTAGGIO INSTALLATION KEY

Per tutti i tipi di aeratore.  
*Service keys for all types of aerators.*



<b>58090</b>			<b>9,90 €</b>
--------------	--	--	---------------



### DOPPIA AGGRAFFATURA DOUBLE INTERLOCK

Flessibile doppia aggraffatura  
in acciaio inox cromato.  
Attacco 1/2"x1/2" conico.  
*Double interlock chromed  
stainless steel flexible hose.  
Connection 1/2"x1/2"  
conical nut.*

 in scatola | in box  
+ 1,30 €

<b>42000CR40</b>	cm 40	<b>11,50 €</b>
<b>42000CR120</b>	cm 120	<b>14,00 €</b>
<b>42000CR150</b>	cm 150	<b>16,00 €</b>
<b>42000CR200</b>	cm 200	<b>18,00 €</b>
<b>42000OR150</b>	cm 150	<b>35,50 €</b>
<b>42000NS150</b>	cm 150	<b>35,50 €</b>
<b>42000VO150</b>	cm 150	<b>35,50 €</b>
<b>42000VR150</b>	cm 150	<b>35,50 €</b>
<b>42000BI150</b>	cm 150	<b>26,50 €</b>
<b>42000NE150</b>	cm 150	<b>26,50 €</b>



### DOPPIA AGGRAFFATURA CON CALOTTA GIREVOLE DOUBLE INTERLOCK WITH SWIVELING CONICAL NUT

Flessibile doppia aggraffatura  
in acciaio inox cromato.  
Attacco 1/2"x1/2" girevole.  
*Double interlock chromed  
stainless steel flexible  
hose. Connection 1/2"x1/2"  
swiveling.*

 in scatola | in box  
+ 1,30 €



<b>42100CR150GI</b>	cm 150	<b>16,90 €</b>
<b>42100CR200GI</b>	cm 200	<b>20,50 €</b>



### SILVER CON CALOTTA GIREVOLE WITH SWIVELING CONICAL NUT

Flessibile PVC argento  
opaco. Attacco  
1/2"x1/2" conico.  
*PVC opaque silver flexible  
hose. Connection 1/2"x1/2"  
conical nut.*



<b>46100AR120GI</b>	1/2"x1/2"	cm 120	<b>18,00 €</b>
<b>46100AR150GI</b>	1/2"x1/2"	cm 150	<b>20,00 €</b>
<b>46100AR200GI</b>	1/2"x1/2"	cm 200	<b>21,50 €</b>



### SILVER EXTRA CON CALOTTA GIREVOLE WITH SWIVELING CONICAL NUT

Flessibile PVC argento  
brillante. Attacco  
1/2"x1/2" conico.  
*PVC brilliant silver flexible  
hose. Connection 1/2"x1/2"  
conical nut.*



<b>46200AR120GI</b>	1/2"x1/2"	cm 120	<b>25,00 €</b>
<b>46200AR150GI</b>	1/2"x1/2"	cm 150	<b>28,00 €</b>
<b>46200AR200GI</b>	1/2"x1/2"	cm 200	<b>29,50 €</b>



### FLEX COLOR

Flessibile PVC con calotta girevole.  
*PVC flexible hose with swiveling nut.*



### FLEX RICAMBIO CUCINA SPARE PARTS KITCHEN FLEX

Flessibile d/a in acciaio inox cromato.  
*Chromed stainless steel flexible hose.*



<b>46100NE150GI</b>	nero   black	cm 150	<b>27,00 €</b>
<b>46100BI150GI</b>	bianco   white	cm 150	<b>27,00 €</b>
<b>46100SSB150GI</b>	inox spazzolato   brushed inox	cm 150	<b>39,00 €</b>

<b>48000CR150</b>	cm 150	<b>18,00 €</b>
-------------------	--------	----------------



### FLEX ALTA PRESSIONE HIGH PRESSURE FLEX

Flessibile in acciaio inox retinato e gommato ad alta resistenza.  
*High-resistance stainless steel flexible hose.*



<b>44000ACC120</b>	cm 120	<b>31,00 €</b>
<b>44000ACC150</b>	cm 150	<b>33,00 €</b>



### PORTASAPONE - SOAP DISH

Portasapone rettangolare 165x80 mm per saliscendi in ABS cromato con riduzione Ø 25 mm, Ø 20 mm e Ø 18 mm.  
*Chromed ABS rectangular soap dish 165x80 mm for sliding rail with reduction Ø 25 mm, Ø 20 mm and Ø 18 mm.*



<b>50000CR</b>	Cromo   Chrome	6,50 €
<b>50000AC</b>	Trasparente   Acrylic	3,40€



### PORTASAPONE CRYSTAL PER SALISCENDI FORO SEZIONE TONDA Ø 18 MM / Ø25MM

Portasapone in metacrilato trasparente con appoggio su laterale inferiore del saliscendi.  
*Soap shelf, transparent methacrylate.*



<b>50260TVT18</b>	Trasparente   Acrylic	57,00 €
<b>50260TVT25</b>	Trasparente   Acrylic	57,00 €



### PORTASAPONE CRYSTAL PER COLONNA FORO SEZIONE TONDA Ø 18 MM

Portasapone in metacrilato trasparente speciale per colonne con tubazione Ø 18 mm, **fornito con doppio supporto a muro.**  
*Single-jet hand shower with anti-limescale. Flexible double interlock with swivel conical connection, length 150cm.*



<b>50261TVT</b>	Trasparente   Acrylic	76,00 €
-----------------	-----------------------	---------



### DUPLEX A FORCELLA DUPLEX IN FORK

Duplex a forcella in metallo.  
*Chromed metal shower duplex.*



51022CR 10,20 €



### DUPLEX A FORCELLE CON ATTACCO ACQUA DUPLEX IN FORK

Duplex a forcella diritta in metallo cromato con presa acqua.  
*Chromed metal straight shower duplex with water supply.*



51030CR 26,00 €



### PRESA ACQUA WATER SUPPLY

Presa acqua in ottone cromato 1/2" M x 1/2" M.  
*Chromed brass water supply flange 1/2" M x 1/2" M.*



52100CR	19,00 €
52100NS	27,00 €
52100VO	27,00 €
52100VR	27,00 €
52100NE	27,00 €
52100OR	29,80 €



### PRESA ACQUA TONDA ROUND WATER SUPPLY

Presa acqua in ottone cromato 1/2" M x 1/2" M.  
*Chromed brass water supply flange 1/2" M x 1/2" M.*



52110CR 26,00 €



### PRESA ACQUA QUADRA SQUARE WATER SUPPLY

Presa acqua in ottone cromato 40 x 40 mm 1/2" M x 1/2" M.  
*Chromed brass water supply 40 x 40 mm 1/2" M x 1/2" M.*



52120CR 33,00 €

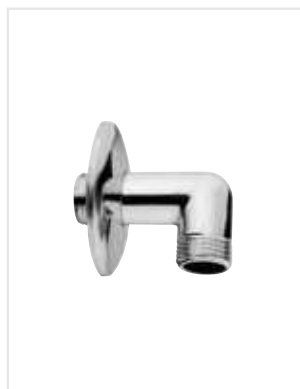

### CURVA DA INCASSO SUPPLY ELBOW

Curva da incasso in ottone cromato con rosone 1/2" M x 1/2" M.  
*Chromed brass supply elbow 1/2" M x 1/2" M.*



52200CR 11,30 €



### SUPPORTO DOCCIA A MURO FIX WALL BRACKET

Supporto per doccia a muro in ABS cromato o ottone.  
*Fixed wall bracket in ABS chromed or brass.*



<b>51100ABSCR</b>	<b>3,90 €</b>
<b>51100ABSBI</b>	<b>3,60 €</b>
<b>51100ABSNE</b>	<b>3,60 €</b>
<b>51100OTCR</b> ottone   brass	<b>19,90 €</b>



### SUPPORTO DOCCIA A MURO FIX WALL BRACKET

Supporto per doccia a muro in ABS cromato o ottone.  
*Chromed or brass ABS fixed wall bracket.*



<b>51110ABSCR</b>	<b>6,70 €</b>
<b>51110ABSBI</b>	<b>6,50 €</b>
<b>51110ABSNE</b>	<b>6,50 €</b>
<b>51110OTCR</b> ottone   brass	<b>24,00 €</b>



### SUPPORTO DOCCIA ANGOLARE ORIENTABLE WALL BRACKET

Orientable wall bracket  
Supporto per doccia angolare in ABS cromato orientabile.  
*Chromed ABS orientable wall bracket.*



<b>51200ABSCR</b>	<b>8,90 €</b>
-------------------	---------------



### SUPPORTO DOCCIA ANGOLARE ORIENTABLE WALL BRACKET

Supporto per doccia angolare in ABS o ottone.  
*ABS or brass orientable wall bracket.*



<b>51210ABSCR</b>	<b>13,00 €</b>
<b>51210OTCR</b> ottone   brass	<b>46,00 €</b>



### SUPPORTO DOCCIA ANGOLARE ORIENTABLE WALL BRACKET

Supporto per doccia angolare in ABS o ottone.  
*ABS or brass orientable wall bracket.*



<b>51220ABSCR</b>	<b>19,20 €</b>
<b>51220OTCR</b> ottone   brass	<b>51,00 €</b>



### SCORREVOLE PORTADOC CIA SLIDING BAR SHOWER HOLDER

Ricambio scorrevole portadoccia quadro 16x16 mm in ottone cromato.  
*Chromed brass shower holder.*



<b>65625CR</b>	<b>91,00 €</b>
----------------	----------------



### SCORREVOLE PORTADOCCIA SLIDING BAR SHOWER HOLDER

Ricambio scorrevole portadoccia tondo Ø 18 mm in ottone cromato.  
*Chromed brass shower holder.*



**65620CR** 66,00 €



### SCORREVOLE PORTADOCCIA SLIDING BAR SHOWER HOLDER

Ricambio scorrevole portadoccia ACQUARIO Ø18mm in ottone cromato.  
*Chromed brass shower holder.*



**65610CR** 121,00 €



### SCORREVOLE PORTADOCCIA SLIDING BAR SHOWER HOLDER

Ricambio scorrevole portadoccia ACQUARIO Ø 18 mm in metallo cromato.  
*Chromed metal shower holder.*



**65611CR** 36,00 €



### DISTANZIALE PIASTRELLE SPACING COLLAR FOR TILE

Distanziale piastrelle, spessore 1 cm in ABS cromato.  
*Chromed ABS spacing collar for tile, thickness 1 cm.*



**65800CR44** 3,70 €  
**65800CR55** 3,90 €



### TAPPO LAVELLO COVER PLATE

Tappo lavello ottone cromato Ø 43 mm.  
*Chromed brass cover plate Ø 43 mm.*



**53000CR** 6,40 €



### SCORREVOLE ABS PORTADOCCIA ABS SLIDING BAR SHOWER HOLDER

Ricambio scorrevole portadoccia per saliscendi in ABS cromato.  
*Chromed ABS sliding bar shower holder.*



**65600CR18** 8,00 €  
**65601CR18** 12,00 €  
**65600CR20** 13,00 €  
**65600CR25** 12,00 €



### SUPPORTO LATERALE DOCCIA SLIDING RAIL BRACKET

Ricambio supporto laterale per saliscendi in ABS cromato.

Chromed ABS sliding rail bracket.

Ø 18

Ø 20

Ø 25



<b>65700CR18</b>	<b>4,10 €</b>
<b>65700CR20</b>	<b>6,20 €</b>
<b>65700CR25</b>	<b>6,50 €</b>



### MEMBRANA TONDA ROUND MEMBRANE

Membrana tonda per SCIROCCO e DELTA.

Membrane for SCIROCCO, DELTA.



**ME05650** 36,00 €



### MEMBRANA QUADRA ROUND MEMBRANE

Membrana per BORA, NETTUNO, OMEGA, EROS.

Membrane for BORA, NETTUNO, OMEGA, EROS.



**ME05632** 36,00 €



### PRESA ACQUA Ø 32 WATER SUPPLY Ø 32

Preso acqua Ø 32 mm a muro in ottone cromato con portadoccia e rosone Ø 50 mm 1/2" M x 1/2" M.

Chromed brass water supply Ø 32 mm with shower holder and rosette Ø 50 mm 1/2" M x 1/2" M.



**PAPDT52** 49,00 €



### PRESA ACQUA QUADRA 25X25 SQUARE WATER SUPPLY 25X25

Preso acqua quadra 25x25 a muro in ottone cromato con portadoccia 1/2" M x 1/2" M. Chromed brass square 25x25 wall water supply with carry shower 1/2" M x 1/2" M.



**PAPDQ52** 54,00 €



### PRESA ACQUA ON/OFF WATER SUPPLY ON/OFF

Preso acqua in ottone cromato con vitone a disco ceramico apertura e chiusura acqua.

Chromed brass water supply with ceramic disc for open/close water.

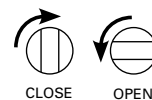

**PAPDOC52** 93,00 €



**PRESA ACQUA  
ON/OFF TONDA  
ROUND WATER  
SUPPLY ON/OFF**

Pres a acqua tonda in ottone cromato con portadoccia e chiusura di sicurezza. Sistema di apertura/chiusura "click" con pressore.  
*Round chromed brass water supply with shower holder and safety closure. Opening/closing system "click" with ball plunger.*

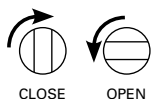

**PAPER308** 92,00 €



**PRESA ACQUA  
ON/OFF QUADRA  
SQUARE WATER  
SUPPLY ON/OFF**

Pres a acqua quadra in ottone cromato e chiusura di sicurezza. Sistema di apertura/chiusura "click" con pressore.  
*Square chromed brass water supply with shower holder and safety closure. Opening/closing system "click" with ball plunger.*

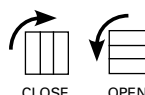

**PAPER407** 101,00 €



**MISCELATORE  
PROGRESSIVO TONDO  
CON PORTADOCCIA  
ROUND PROGRESSIVE  
MIXER WITH SHOWER  
HOLDER**

Miscelatore tondo da incasso per doccette in ottone cromato.  
*Round concealed mixer for handshowers in chromed brass*



**PAMIS800** 355,00 €



**MISCELATORE  
PROGRESSIVO QUADRO  
CON PORTADOCCIA  
SQUARE PROGRESSIVE  
MIXER WITH SHOWER  
HOLDER**

Miscelatore quadro da incasso per doccette in ottone cromato.  
*Square concealed mixer for handshowers in chromed brass.*

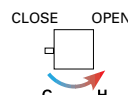

**PAMIS900** 460,00 €

## SIT - BENCH



### SIT

Sgabello in metacrilato/plexiglass utilizzabile all'interno o all'esterno del box doccia.  
*Methacrylate/plexiglass stool usable inside or outside the shower box.*

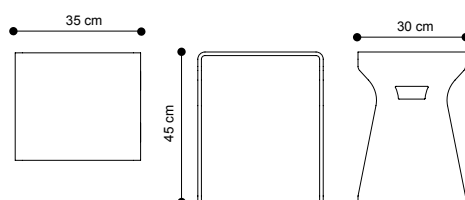

<b>50161VT</b>	Trasparente   Transparent	<b>330,00 €</b>
<b>50161CO</b>	Colore   Colour	<b>360,00 €</b>
<b>50BAR</b>	Aggiunta barra stabilizzatrice   Addition of stabilizer bar	<b>42,00 €</b>



### BENCH

Sgabello in metacrilato/plexiglass utilizzabile all'interno o all'esterno del box doccia.  
*Methacrylate/plexiglass stool usable inside or outside the shower box.*

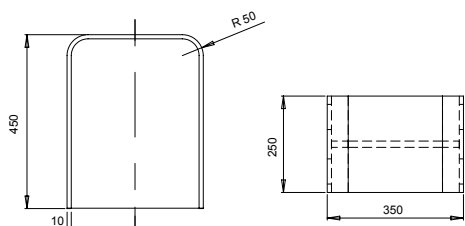

<b>50160VT</b>	Trasparente   Transparent	<b>330,00 €</b>
<b>50160CO</b>	Colore   Colour	<b>360,00 €</b>
<b>50BAR</b>	Aggiunta barra stabilizzatrice   Addition of stabilizer bar	<b>42,00 €</b>



\* Su richiesta in colorazione diversa \_ Different colours on request

# SELLA



Immagine a titolo esemplificativo \_ Image as an example

Accessorio di grande funzionalità in metacrilato da posizionare con il semplice appoggio a cavallo sulla parete fissa del box doccia senza necessità di forature. Funzione a doppio uso: internamente dispone di vani portaoggetti e/o portasapone ed esternamente portaaccappatoio.

*Extremely useful accessory made of methacrylate to be placed by simply laying it astraddle of the fix shower wall without any holes. Double use: inside it has various soap and/or object trays, outside a bathrobe hanger.*

50060VT

Trasparente | Transparent

385,00 €

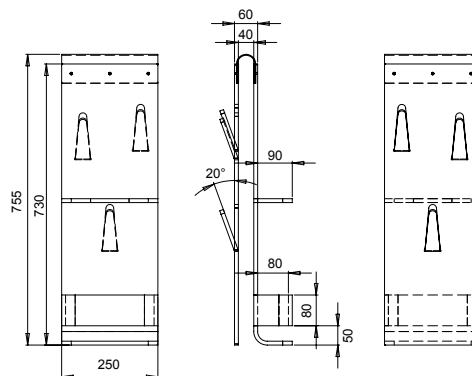

## FRECCIA



Immagine a titolo esemplificativo \_ Image as an example

Portaoggetti per box doccia appendibile in plexiglas.  
Disponibile in colorazioni diverse.  
*Plexiglass hanging shower caddy.*  
*Available in different colours.*

**50061VT** Plexiglass 210,00 €

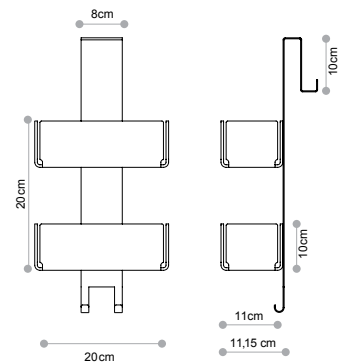

# PIZZICO



Immagine a titolo esemplificativo \_ Image as an example

Portaoggetti per box doccia appendibile in plexiglas.  
Disponibile in colorazioni diverse.  
*Plexiglass hanging shower caddy.*  
*Available in different colours.*

<b>50062VT1</b>	Plexiglass	<b>180,00 €</b>
<b>50062VT2</b>	Plexiglass	<b>229,00 €</b>

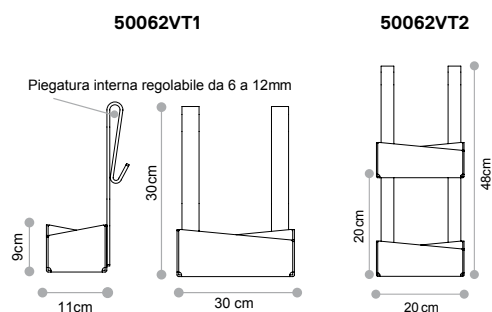

# ABBRACCIO



Immagine a titolo esemplificativo \_ Image as an example

Portaoggetti per box doccia appendibile in plexiglas.  
Disponibile in colorazioni diverse.  
*Plexiglass hanging shower caddy.*  
*Available in different colours.*

<b>50063VT1</b>	Plexiglass	<b>178,00 €</b>
<b>50063VT2</b>	Plexiglass	<b>224,00 €</b>

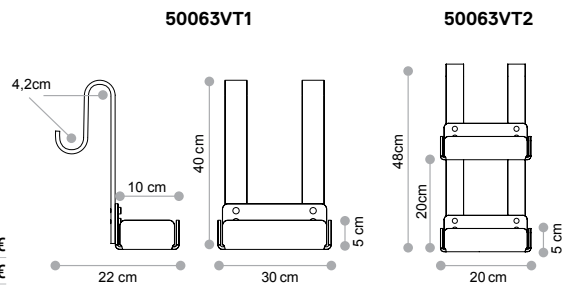

## DOUBLE



Immagine a titolo esemplificativo \_ Image as an example

Portaoggetti per box doccia appendibile in plexiglas.  
Disponibile in colorazioni diverse.  
*Plexiglass hanging shower caddy.*  
*Available in different colours.*

<b>50064VT1</b>	Plexiglass	<b>135,00 €</b>
<b>50064VT2</b>	Plexiglass	<b>165,00 €</b>

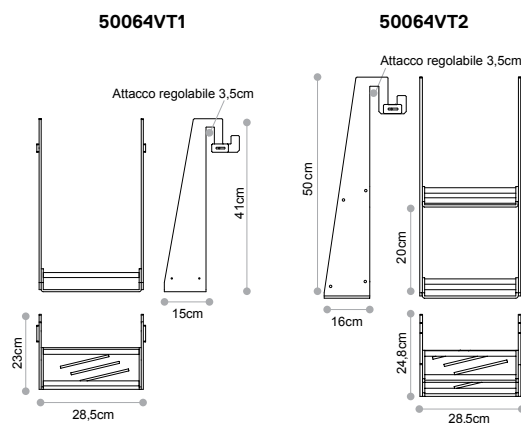

## SIR BISS



Immagine a titolo esemplificativo \_ Image as an example

Gancio per box doccia in plexiglas. Disponibile in colorazioni diverse.  
*Plexiglass shower hook. Available in different colours.*

<b>50065VTM</b>	Plexiglass	<b>29,00 €</b>
<b>50065VTG</b>	Plexiglass	<b>31,00 €</b>

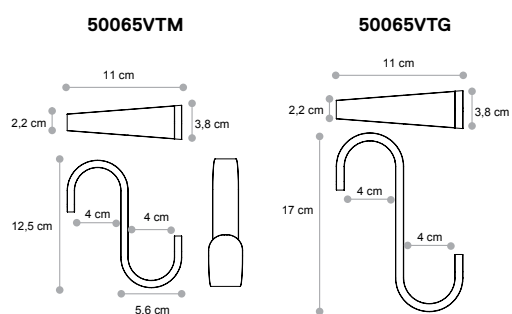

## **PULIZIA**

Sporco secco (polvere): consigliamo uno straccio inumidito con acqua. Sporco grasso/unto: consigliamo la pulizia con una spugna bagnata con acqua e detersivo neutro (privo di abrasivi) e quindi con panno inumidito con acqua. Evitare l'uso di detersivi contenenti.

## **CLEANING**

*Dry dirt (dust): we recommended a wet cloth. Grease/oil dirt: we recommended to wipe first with a lightwashing liquid (not aggressive) and then with a wet cloth. Avoid detergents containing solvents and/or ethyl alcohol. solventi e/o alcool etilico.*











AQUAVIVA srl  
Via Pascoli, 51 - Zona industriale Gabbio  
28881 Casale Corte Cerro (VB) Italy  
tel. +39 0323 840844

[www.aquaviva-srl.com](http://www.aquaviva-srl.com)  
[aquaviva@aquaviva-srl.com](mailto:aquaviva@aquaviva-srl.com)