

**hotech**  
DESIGN RADIATORS

# INDEX

02	<b>CRAFTSMANSHIP</b>	82	<b>LEAF FINISHING</b>
04	<b>TECHNOLOGY</b>	84	VASARI
08	<b>ARCHITECTURAL</b>	86	VASILY
10	RECESSED SYSTEM	88	DAVID
14	CORNER SYSTEM 1	89	EVA
16	CORNER SYSTEM 2	90	DUAL
18	CORNER SYSTEM 3	92	BAUHAUS
20	<b>HYBRID POWER</b>	94	CAVE ADSUM
22	<b>PERSONALIZZAZIONE</b>	96	<b>LIVING &amp; bathroom</b>
24	SIZES	98	PRINCESS
26	SHAPE	100	KLIMT
28	ENGRAVING	102	WILDE
30	CUT AND HOLES	104	QUADRO
32	LOGO	106	GECO
34	LED	108	GECO DOUBLE
36	POLISHED	110	<b>DOUBLE</b>
38	<b>FINISHING</b>	112	ECLIPSE
38	LEAF FINISHING	114	BREUER
40	TECHNICAL FINISHING	116	BERNINI
42	<b>INDUSTRIAL ALU</b>	118	MODULE
46	<b>PALETTE RAL</b>	120	MODULE DOUBLE
48	<b>ENJOY THE SOUND</b>	122	GRACE
50	55	124	BOCCIONI
56	<b>BATHROOM &amp; living</b>	126	<b>SHAPING THE FUTURE</b>
58	FABERGÈ	128	PARALLAX
60	MONO	130	MAGRITTE
62	EILEEN	134	<b>MATERIALS</b>
64	STRIP	136	MEDICEO
66	SOLIS	138	HERMITAGE
68	ZWART	140	<b>OPRA LINE</b>
70	FEATHER	142	OPRA
72	MODULE	144	<b>ACCESSORIES</b>
74	LEY	144	BARS
76	ANASTASIA	146	COAT HANGERS
78	TRIADE	148	<b>ECOLOGY</b>
80	ROMANOV	150	<b>VALVE KIT</b>
		151	<b>REMOTE VALVES</b>
		152	<b>THERMOSTAT</b>

# CRAFTSMANSHIP

**L**a qualità, la sostenibilità dei materiali, il design, la cultura del progetto, il Made in Italy, in molti casi il lusso; questi sono i grandi valori aggiunti dei radiatori Hotech. Imprescindibile è soprattutto la capacità di lavorazione artigianale, che Hotech apporta grazie alle forti competenze di prodotto maturate negli anni; un know-how che ha consentito di raggiungere e mantenere un posizionamento elevato nel mercato. Una professionalità frutto dell'esperienza e dei propri valori, ma anche della ricerca costante, che si traduce in continua innovazione.

L'arte artigianale Made in Italy, supera le barriere imposte dal prodotto standardizzato, per offrire al cliente un livello elevato di personalizzazione del termoarredo. Quando si sceglie un prodotto firmato Hotech, non si acquista un semplice oggetto, uguale a tanti altri, ma un elemento, frutto della fusione di creatività, tecnica ed emozioni; le abili mani degli artigiani italiani, danno vita a capolavori unici nel loro genere, curati in ogni minimo dettaglio. Ogni particolare ha una lunga storia da raccontare ed è proprio questo che rende i radiatori Hotech così sofisticati e raffinati.

La qualité, la soutenabilité des matériaux, le design, la culture du projet, le Made in Italy, dans certains cas le luxe : ceci sont les grandes valeurs ajoutées des radiateurs Hotech.

Incontournable est surtout la capacité de travail artisanal, que Hotech apporte grâce aux solides compétences de produit acquises au fil des années. Un savoir-faire qui a permis d'atteindre et de maintenir une position élevée sur le marché. Un professionnalisme issu de l'expérience et des valeurs, mais aussi de la recherche constante, qui se traduit par une innovation continue.

L'art artisanal Made in Italy, surmonte les barrières imposées par le produit standardisé, pour offrir au client un niveau élevé de personnalisation du radiateur décoratif. Quand on choisit un produit signé Hotech, on n'achète pas un simple objet, identique à tant d'autres, mais un élément, résultat de la fusion de la créativité, de la technique et des émotions ; les mains habiles des artisans italiens, donnent vie à des chefs-d'œuvre uniques dans leur genre, soignés dans les moindres détails. Chaque détail a une longue histoire à raconter et c'est précisément ce qui rend les radiateurs Hotech si sophistiqués et raffinés.

Quality, the sustainability of materials, design, project culture, Made in Italy and, in many cases, luxury constitute the great added value of Hotech radiators. An essential aspect is mainly represented by artisan manufacturing capacity, which is guaranteed by Hotech thanks to the strong product expertise developed over the years; this is the know-how that has enabled the company to reach and maintain a high position in the market. Professionalism as a result of experience and of its own values, but also of constant research, which materialises in continuous innovation.

The Made in Italy artisan art goes beyond the barriers set by standardised products, in order to offer customers a high level of customisation for radiators. When you choose a Hotech product, you are not merely purchasing a simple object, just like so many others, but rather an element fruit of the combination of creativity, technique and emotions; the skilful hands of Italian artisans give life to masterpieces that are unique in their kind, paying attention to every little detail. Every single detail has a long story to be told, and it is precisely this what makes Hotech radiators so sophisticated and refined.

Качество, экологичность материалов, дизайн, культура проекта, Made in Italy, часто роскошь; это дополнительные преимущества радиаторов Hotech.

Неотъемлемой их характеристикой является качество ручной работы, которого Hotech достигает благодаря многолетнему опыту - это «ноу-хау» позволило компании завоевать и удержать своё высокое положение на рынке. Профессионализм, основанный на опыте, ценностях и непрерывном поиске, ведёт к постоянным инновациям.

Ремесленное искусство Made in Italy преодолевает барьеры стандартного производства и предлагает клиенту более высокий уровень персонализации радиаторов. Выбирая товар марки Hotech, будьте уверены: вы не приобретаете один из многочисленных радиаторов, похожих на все остальные... Вы получаете элемент интерьера, являющийся плодом фантазии, техники и эмоций. Знающие руки итальянских ремесленников дают жизнь настоящим шедеврам, уникальным в своём роде и неповторимым в каждой детали. Каждый их элемент словно рассказывает свою историю, и именно это делает радиаторы Hotech столь современными и изысканными.

**U**no dei segreti del successo di Hotech, risiede nella lavorazione tecnologica avanzata, applicata per la realizzazione dei radiatori. I termoarredi sono ottenuti con una tecnica brevettata che implica la lavorazione tridimensionale del metallo, utilizzando tecnologie complesse e competenze tecniche di alto livello.

L'utilizzo esclusivo di metalli nobili, non ferrosi ed altamente conduttivi, come l'alluminio ed il rame, accoppiati in modo ottimale, come solo Hotech è in grado di offrire; garantiscono elevate prestazioni, rapidità di esercizio e alte rese, a fronte di un consistente risparmio energetico. Ricorrendo a questo sistema produttivo, l'intero apparato tecnologico è sintetizzato nello spessore di soli 8 millimetri; trovarsi di fronte ad un potente radiatore, sottile quanto uno smartphone, ci ricorda che anche l'impossibile a volte può diventare realtà. Hotech con i suoi prodotti, ha segnato un passaggio evolutivo nella storia della produzione di caloriferi, per il riscaldamento di ambienti domestici e pubblici.

Il corpo dei radiatori è ottenuto dalla lavorazione dal pieno dell'alluminio con sofisticati macchinari a controllo numerico; ogni oggetto può quindi vantare caratteristiche di durabilità, robustezza e continuità d'efficienza, che vanno oltre ogni standard esistente sul mercato.

4

L'un des secrets du succès de Hotech, réside dans le traitement technologique avancé, appliqué à la réalisation des radiateurs. Les radiateurs décoratifs sont obtenus avec une technique brevetée qui implique le traitement tridimensionnel du métal, en utilisant des technologies complexes et des compétences techniques de haut niveau.

L'utilisation exclusive de métaux nobles, non ferreux et très conducteurs, tels l'aluminium et le cuivre, couplés de façon optimale, comme seulement Hotech peut offrir. Ils garantissent des prestations élevées, la rapidité d'exercice et des hauts rendements, en échange d'une importante économie d'énergie.

En utilisant ce système productif, tout l'appareil technologique est synthétisé dans une épaisseur de seulement 8 millimètres ; se trouver devant un radiateur puissant, aussi mince qu'un smartphone, nous rappelle que même l'impossible peut parfois devenir réalité.

Le corps des radiateurs est obtenu en travaillant de l'aluminium en bloc avec des machines à commande numérique sophistiquées ; chaque objet peut ainsi revendiquer des caractéristiques de durabilité, de robustesse et de continuité d'efficacité, qui vont au-delà de tout standard existant sur le marché.

One of the secrets of Hotech's success lies in the advanced technological manufacturing applied for making radiators. Radiators are obtained with a patented technique involving the three-dimensional processing of metal, by using complex technologies and high-level technical skills.

The exclusive use of noble, non-ferrous, highly conductive metals, such as aluminium and copper, coupled in a perfect manner – the way only Hotech can offer – guarantees high performance, quick operation and high efficiency, as well as constant energy saving.

By resorting to this production system, the thickness of the entire technological equipment could be reduced to only 8 millimetres; standing in front of a powerful radiator – as thin as a smartphone – reminds us that even the impossible can sometimes be achieved. With its products, Hotech have marked an evolutionary passage in the history of the production of radiators, for heating rooms in domestic and public areas.

The body of radiators is obtained by machining billet aluminium with sophisticated numerical control machines; each object is therefore characterised by durability, robustness and continuous efficiency, going beyond the standards existing in the market.

Один из секретов успеха Hotech состоит в применении в процессе производства самых передовых технологий. Радиаторы создаются по запатентованной технологии, использующей трёхмерную обработку металла с применением сложных техник и навыков высокого уровня.

Использование исключительно благородных, нежелезистых металлов с высокой проводимостью, таких как алюминий и медь, в неповторимом стиле Hotech гарантирует высокие показатели работы, скорость нагрева и высокую продуктивность в сочетании со значительной экономией энергии.

При использовании этой производственной системы вся техническая часть заключена в конструкцию толщиной всего лишь восемь миллиметров. Мощный радиатор, тонкий как смартфон? Иногда даже невозможное становится возможным. Продукция Hotech возвела производство радиаторов для дома и общественных помещений на новый виток эволюции.

Корпус радиаторов производится из монолитного алюминия, обрабатываемого при помощи сложных станков с числовым программным управлением; каждое изделие отличается долговечностью, прочностью и стабильностью, намного превышающими стандарты рынка.

5



Circuito idraulico in rame  
Copper Hydraulic circuit  
Circuit Hydraulique en cuivre  
Медная гидравлическая цепь

6

IN / OUT

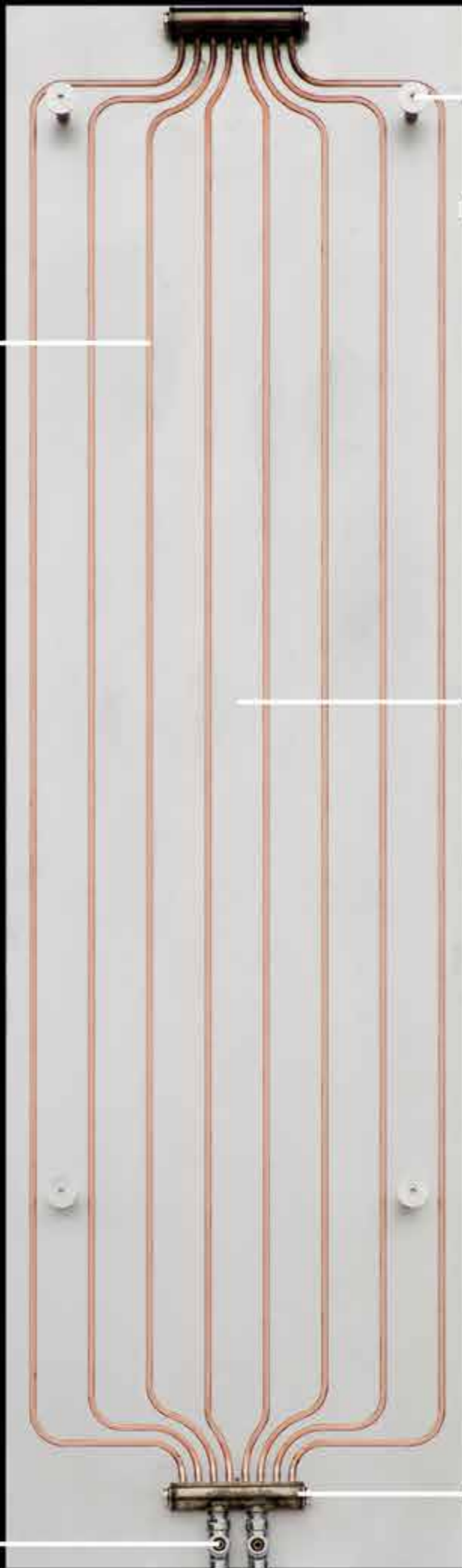

Supporto in alluminio H 7cm  
Aluminum support H 7cm  
Support en aluminium H 7cm  
Поддержка в алюминии H 7cm

Piastra radiante  
Radiating plate  
Plaque rayonnante  
Излучающая пластина

Collettori in acciaio AISI 304  
INOX steel collectors AISI 304  
Manifolds INOX AISI 304  
Многообразия  
в нержавеющей  
стали AISI 304

Supporto in alluminio H 5cm  
Aluminum support H 5cm  
Support en aluminium H 5cm  
Поддержка в алюминии H 5cm

Resistenza doppio isolamento  
Classe 2 - 50W/metro lineare  
Resistance double insulation  
Class 2 - 50W/linear meter  
Résistance double isolation  
Classe 2 - 50W/mètre linéaire  
Двойное сопротивление изоляции  
Класс 2 - 50 Вт / линейный метр

Cavo di connessione  
Connection cable  
Câble de connexion  
Соединительный кабель

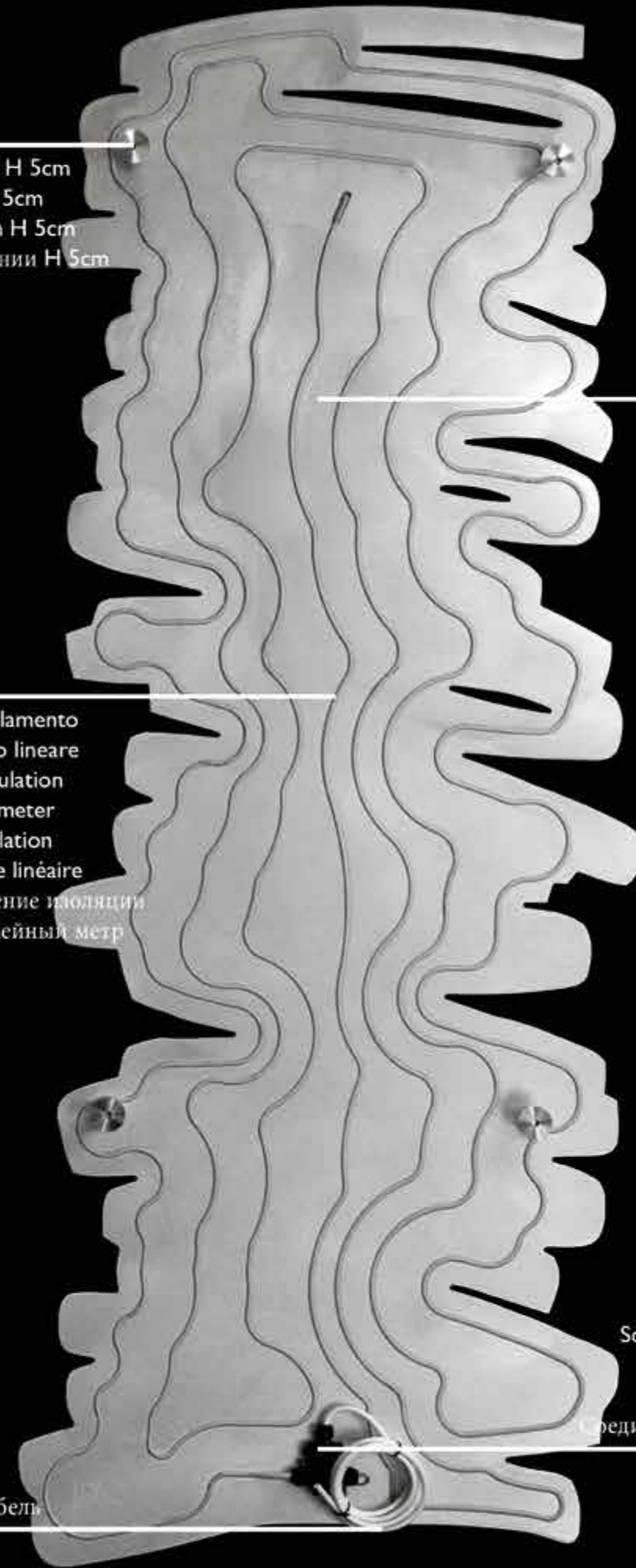

Piastra radiante  
Radiating plate  
Plaque rayonnante  
Излучающая пластина

Scatola di connessione IP64  
Connection box IP64  
Boite de connexion IP64  
Соединительная коробка IP64

7

**I**l minimalismo in architettura è una tendenza che a partire dagli anni sessanta non è mai passata di moda; celebra l'essenzialità, l'astrazione e la geometria, seguendo il motto "Less is more".

Nello stile minimalista, l'architettura, gli interni, gli arredi e i complementi, devono interagire per creare un ambiente il più coerente possibile, sul piano espressivo.

Hotech ha perciò sviluppato un'intera linea di termoarredi, studiati per fondersi con le superfici e le geometrie sulle quali vengono collocati, esaltando la pulizia visiva e la linearità degli ambienti, che siano domestici, pubblici o commerciali.

I radiatori della "linea architettonica" offrono evidenti vantaggi sia dal punto di vista estetico che dal punto di vista pratico funzionale, ottimizzando ogni spazio, senza pregiudicare il rendimento termico dei corpi scaldanti.

Hotech si rivolge con questi pezzi ai clienti privati, ma soprattutto ai progettisti e architetti più esigenti, che possono finalmente avere a disposizione, sistemi di riscaldamento che si adattano a qualsiasi forma e dimensione.

8

Le minimalisme en architecture est une tendance qui, depuis les années soixante, ne s'est jamais démodée ; il célèbre l'essentialité, l'abstraction et la géométrie, en suivant la devise « Less is more ». Dans le style minimaliste, l'architecture, les intérieurs, l'ameublement et la décoration, doivent travailler ensemble pour créer un environnement aussi cohérent que possible, sur le plan expressif.

Hotech a donc mis au point toute une gamme de radiateurs décoratifs, conçus pour se fondre avec les surfaces et les géométries sur lesquelles ils sont placés, exaltant le visuel et la linéarité des environnements, qu'ils soient domestiques, publics ou commerciaux. Les radiateurs de la « ligne architecturale » offrent des avantages évidents tant du point de vue esthétique que du point de vue fonctionnel pratique, en optimisant chaque espace, sans compromettre la performance thermique des corps de chauffe. Hotech s'adresse, avec ces pièces, à sa clientèle privée, mais surtout aux designers et architectes les plus exigeants, qui ont enfin à leur disposition des systèmes de chauffage qui s'adaptent à toutes les formes et dimensions.

Minimalism in architecture is a tendency that – since the 1960s – has never gone out of fashion; it celebrates essentiality, abstraction and geometry, following the "Less is more" maxim. In the minimalist style, architecture, interiors, furniture and complements must interact in order to create an environment as coherent as possible, in terms of expression.

Hotech have therefore developed a complete line of radiators that have been studied so that they can merge into the surfaces and geometries on which they are placed, exalting the visual neatness and the linearity of rooms, whether they are domestic, public or commercial.

The radiators of the "architectural line" offer clear advantages not only from the aesthetic point of view but also from the practical-functional point of view, optimising each single space, without impairing the thermal performance of heating appliances.

Hotech address these pieces to private customers, but mainly to the most demanding designers and architects, who can finally have at their disposal heating systems that can be adapted to any shape and dimension.

Минимализм в архитектуре - это тенденция, которая, начиная с 60-х годов, так и не вышла из моды. Её основы - существенность, абстракция и геометрия, а главный принцип «lessismore» (меньше - значит больше).

В минималистском стиле архитектура, интерьеры, мебель и аксессуары должны взаимодействовать между собой для создания наиболее связанного в экспрессивном плане пространства. Поэтому Hotech разработала целую линию радиаторов, призванных слиться с поверхностями и геометрическими формами, на которых они будут размещены, подчёркивая визуальную чистоту и линейность помещений - как домашних, так и общественных или коммерческих.

Радиаторы «архитектурной» линии обладают рядом очевидных преимуществ как с эстетической, так и с практической точки зрения. Они оптимизируют любое пространство, не жертвуя при этом своей обогревательной способностью.

Hotech предлагает эти изделия как частным клиентам, так и самым требовательным проектировщикам и архитекторам, которые наконец могут получить радиаторы любой формы и размера.

9



ARCHITECTURAL

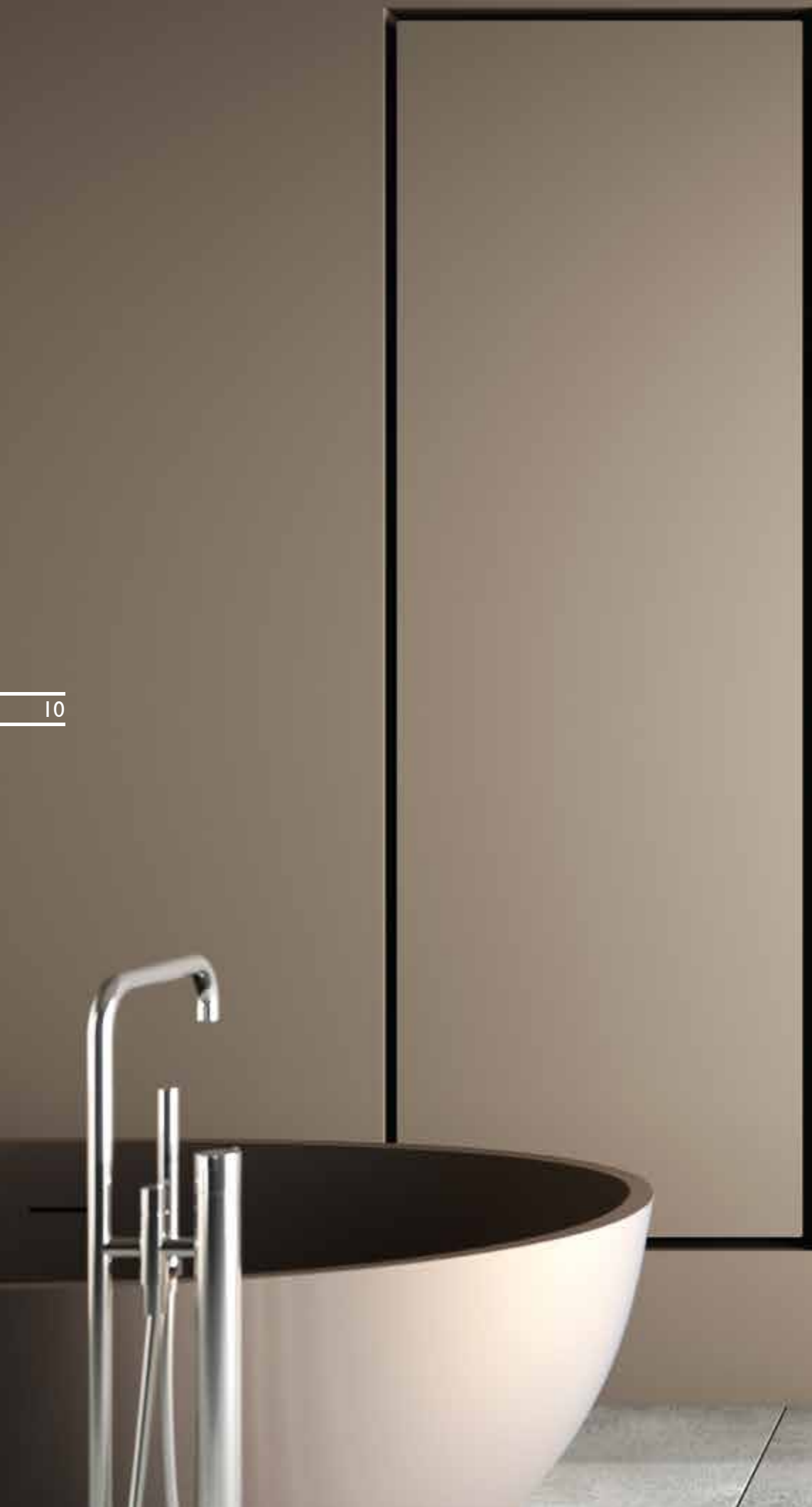

## RECESSED SYSTEM

design by Hotech

Il radiatore acquisisce la possibilità di divenire un tutt'uno con lo spazio, azzerando il suo ingombro e uniformandosi con l'area utile delle pareti. Questa soluzione è stata studiata e predisposta, per supportare la finitura finale della parete stessa, permettendo quindi di verniciare, stuccare o resinare il radiatore, rimuovendo ogni ingombro visivo e massimizzando gli spazi.

Radiators can become one with the room around; the space they take is minimized as they blend with the wall where they are fitted. This solution has been designed and developed so that radiators can be varnished, stuccoed or resin-coated similarly to the wall where they are mounted, removing any visual obstacle and maximizing space.

Le radiateur acquiert la possibilité de devenir un tout avec l'espace, en mettant à zéro son volume et en se conformant à la zone utile des murs. Cette solution a été conçue et préparée pour supporter la finition finale du mur lui-même, permettant ainsi de peindre, stucquer ou résiner le radiateur, en supprimant tout encombrement et en maximisant l'espace.

Радиатор приобретает возможность стать единым целым с окружающим его пространством, не загружая помещение и сливаясь с площадью стены. Это решение было разработано для поддержки однородности отделки стены, делая возможным покраску, оштукатуривание или лакировку радиатора для устранения визуальной загрузки и максимизации пространства.

# RECESSED SYSTEM

design by Hotech



# CORNER SYSTEM 1

design by Hotech

14



**SIZES**  
custom



**FINISHING**  
pag. 55



**ACCESSORIES**  
pag. 44



**INTERAXIS**  
center to center variable  
distance

15

# CORNER SYSTEM 2

design by Hotech

16



17



**SIZES**  
custom



**FINISHING**  
pag. 55



**ACCESSORIES**  
pag. 44



**INTERAXIS**  
center to center variable  
distance

# CORNER SYSTEM 3

design by Hotech

18

19



SIZES  
custom



ACCESSORIES  
pag. 44



FINISHING  
pag. 55



INTERAXIS  
center to center variable  
distance

# HYBRID POWER

**I**l sistema “Hybrid Power” di Hotech prevede l'utilizzo combinato di due diverse tecnologie e differenti fonti di energia; molti sono i vantaggi che ne derivano, per il miglioramento della qualità della vita e dell'ambiente.

I termoarredi ibridi, fondono perfettamente il sistema idronico a quello elettrico, in un componente ibrido estremamente compatto. Le due alimentazioni possono lavorare singolarmente oppure insieme, consentendo di selezionare di volta in volta il generatore più efficiente in base alla temperatura e al fabbisogno energetico dell'abitazione.

Entrambe le tecnologie, sono predisposte per sfruttare al meglio le fonti di energia rinnovabile, presenti nelle nuove abitazioni, come i pannelli solari termici e i pannelli fotovoltaici; un termoarredo ibrido è quindi una scelta sostenibile, che può ridurre sprechi ed emissioni.

Un doppio sistema energetico nel calorifero, significa anche doppia affidabilità, garantendone il funzionamento ed il massimo comfort, anche in condizioni critiche, dovute a guasti o sospensioni parziali delle forniture energetiche.

Le système « Hybrid Power » de Hotech représente « l'évolution de l'espèce » : il implique l'utilisation combinée de deux technologies différentes et de différentes sources d'énergie ; il en résulte de nombreux avantages pour l'amélioration de la qualité de la vie et de l'environnement.

Les radiateurs décoratifs hybrides, conçus par la Hotech Design Radiators, combinent parfaitement les systèmes hydronique et électrique dans un système hybride extrêmement compact. Les deux alimentations peuvent fonctionner individuellement ou ensemble, vous permettant de sélectionner de temps en temps le générateur le plus efficace en fonction de la température et des besoins énergétiques de la maison.

Les deux technologies sont conçues pour tirer le meilleur parti des sources d'énergie renouvelables présentes dans les nouvelles maisons, telles que les panneaux solaires thermiques et les panneaux photovoltaïques ; un radiateur décoratif hybride est donc un choix soutenable, qui peut réduire les déchets et les émissions.

Un double système énergétique dans le calorifère signifie également une double fiabilité, garantissant un fonctionnement et un confort maximum, même dans des conditions critiques, en raison de pannes ou de suspensions partielles d'alimentation en énergie.

The 'Hybrid Power' system by Hotech is 'the evolution of the species': It combines two different technologies and different sources of energy. This results in a myriad of advantages that enhance the quality of both life and the environment.

The hybrid radiators designed by Hotech Design Radiators perfectly blend the hydronic and the electric systems into a highly compact hybrid system. The two supply systems can work together or independently so that you can choose the generator that is more efficient according to the temperature and the energy requirements of the house, on a case-by-case basis.

Both technologies are at your disposal to make the best possible use of renewable energy sources found in modern time homes, such as solar thermal collectors and photovoltaic panels. Therefore, a hybrid radiator is a sustainable choice that can cut down wastage and emissions. A double energy system in a radiator also means twice as much reliability since operation and total comfort are guaranteed, even under critical conditions caused by failures or partial interruptions of the power supply.

Система HybridPower, предлагаемая Hotech, представляет собой новый эволюционный виток: она предусматривает комбинированное использование двух разных технологий и источников энергии, что создаёт многочисленные возможности для улучшения качества жизни и сохранения окружающей среды.

Гибридные радиаторы, спроектированные Hotechdesignradiators, идеально сочетают в себе водопроводные и электрические компоненты, представляя собой ультракомпактную гибридную систему. Два источника питания могут работать по отдельности или вместе, позволяя каждый раз выбирать наиболее продуктивный генератор, основываясь на температуре и энергетической потребности помещения. Обе технологии способны наилучшим образом использовать обновляемые источники энергии, которыми оснащены новые постройки, такие как солнечные коллекторы и фотоэлектрические панели. Двойная энергетическая система радиатора означает также двойную надёжность, гарантируя постоянство работы и максимальный комфорт даже в случаях поломок или частичного прекращения подачи энергии.

**U**n plus della produzione di Hotech design radiators, è la possibilità di personalizzazione totale del prodotto, per garantire la piena soddisfazione al cliente.

La gamma dei colori disponibile in pronta consegna copre tutta la scala RAL; su richiesta sono avviabili anche tutte le nuance dei colori pantone, oltre che il servizio di rilievo e riproduzione di una particolare tonalità, a partire da un campione fisico. Molteplici sono anche le finiture artigianali, come gli spazzolati e la posa di foglia oro, argento e rame, rigorosamente fatta a mano, seguendo le antiche tecniche della tradizione. Sempre sull'area superficiale dell'oggetto è possibile la riproduzione di disegni, scritte o loghi, tramite incisioni a contrasto, colorate o tono su tono. La dimensione non è più un limite, così come la forma, Hotech realizza termoarredi seguendo qualsiasi disegno o sagoma, effettuando anche fori ed aperture sulla superficie radiante, senza alcuna problematica tecnica. Possibilità di personalizzazione ancora maggiori, si ottengono con la conversione a specchio e la lucidatura della superficie; oppure con l'utilizzo del particolare alluminio con finitura grezza "rusted" e l'applicazione della retroilluminazione led, totale o parziale.

22

Un plus de la production de Hotech Design Radiators est la possibilité de personnalisation totale du produit, pour assurer la satisfaction totale du client. La gamme de couleurs disponibles pour une livraison immédiate couvre l'ensemble de l'échelle RAL ; sur demande, toutes les nuances des couleurs Pantone.

Il existe également de nombreuses finitions artisanales, telles que les brossés et la pose d'or, d'argent et de cuivre, strictement à la main, suivant des techniques traditionnelles anciennes.

Toujours sur la surface de l'objet, il est possible de reproduire des dessins, des textes ou des logos, à travers des gravures contrastées, colorées ou ton sur ton. La taille n'est plus une limite, ainsi que la forme, Hotech réalise des radiateurs décoratifs en suivant n'importe quelle conception ou forme, faisant également des trous et des ouvertures sur la surface radiante, sans aucun problème de nature technique. Possibilités de personnalisation encore plus grandes, sont obtenues avec la conversion au miroir et le polissage de la surface ; ou avec l'utilisation de l'aluminium particulier avec une finition rugueuse « rouillée » et l'application du rétro-éclairage LED total ou partiel.

A plus in Hotech Design Radiators production is the possibility of completely customising products, in order to guarantee customers' full satisfaction.

The variety of colours available for prompt delivery covers the whole RAL range; upon request, the company can also offer all the nuances of pantone colours, as well as the service involving the sampling and reproduction of a particular shade, starting from a physical sample. There are also multiple artisan finishes, such as brushing and gold, silver and copper leaf laying, which is strictly made by hand, following ancient traditional techniques. On the superficial area of the objects, drawings, inscriptions or logos can also be reproduced, by means of contrast engraving, either coloured or ton sur ton.

Neither dimensions nor shapes constitute a limit any longer; Hotech make radiators following any design or shape, also making holes and openings on the radiant surface, without any technical problem. Even further customisation possibilities are obtained by converting the surface into a mirror and polishing it, or by using special aluminium with a 'rusted' finish and applying total or partial LED backlighting.

Преимуществом продукции Hotech design radiators является возможность полной персонализации продукта, гарантирующая полное удовлетворение запросов клиента. Доступная гамма цветов покрывает всю шкалу RAL; по запросу доступны любые оттенки цветов Pantone, а также услуга снятия и изготовления конкретного оттенка с физического образца. Доступны также многочисленные виды поверхностной обработки, такие как «расчёсывание», покрытие золотом, серебром, медью, выполненные исключительно вручную по старинным традиционным техникам. Также на поверхности изделия возможно разместить рисунки, надписи или логотипы посредством контрастной, цветной или одноцветной гравировки.

Размер и форма больше не являются препятствием. Hotech создаёт радиаторы, следуя любым проектам или эскизам, выполняя также вырезы и отверстия на поверхности радиатора без ущерба для технической части. Ещё больше возможностей для персонализации открывается при использовании зеркальной и глянцевой поверхности или применении специального алюминия с покрытием под «ржавчину» и добавлением подсветки, полной или частичной.

# CUSTOMIZATION

23



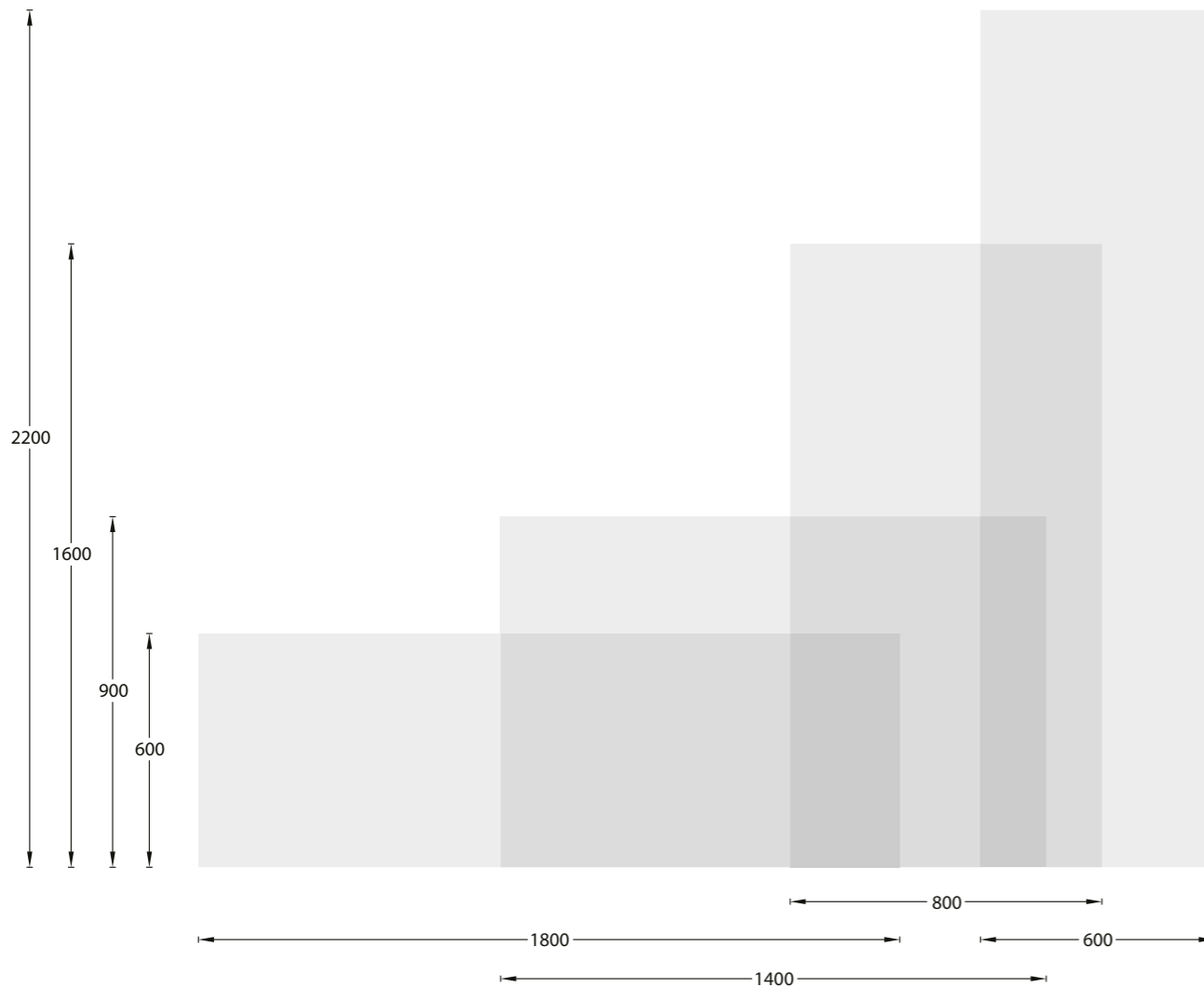

## SIZES

I radiatori Hotech superano ogni limite dimensionale: prodotti "Tailor-made" costruiti sulle esigenze del cliente. Non esistono misure standardizzate, la tecnologia Hotech è nata per adattarsi alle più moderne situazioni architettoniche, permettendo di variare la posizione ed interasse degli attacchi, oltre che la dimensione e il profilo di ogni lato.

There are no size limits for Hotech radiators. Tailor-made items built to suit the requirements and needs of our customers. There are no standard sizes. Hotech technology is here to adapt to the most modern architecture scenarios and so the position of fittings and their distance between centres as well as the size and profile of each side can be changed.

Les radiateurs Hotech dépassent toute limite de taille : produits « sur mesure », construits sur les besoins des clients. Il n'y a pas de mesures standardisées, la technologie Hotech est née pour s'adapter aux situations architecturales les plus modernes, ce qui permet de faire varier la position et l'entraxe des fixations, ainsi que la taille et le profil de chaque côté.

Радиаторы Hotech превосходят все ожидания в области размеров: это уникальные изделия, созданные на основе запросов клиента. Стандартных размеров не существует: технология Hotech родилась для того, чтобы адаптироваться к самым современным архитектурным решениям, позволяя изменять расположение и расстояние между креплениями, а также размеры и профиль каждой стороны.

# SHAPE

La tecnologia Hotech è l'unica in grado di offrire la completa customizzazione dei suoi prodotti, realizzando su richiesta, qualsiasi forma e sagoma in dimensioni variabili e personalizzate; pezzi unici o piccole tirature, prodotte ad-hoc per il cliente, con la massima qualità e cura del dettaglio.

Hotech has the only technology that can offer total product customization. Any shape and contour can be made upon request at different and personalized sizes. Single pieces or low volume applications made ad-hoc for a customer guaranteeing total quality and care for details.

La technologie Hotech est la seule capable d'offrir la personnalisation complète de vos produits, en réalisant sur demande, toute forme et modèle en dimensions variables et personnalisées ; pièces uniques ou en petites séries, produites spécialement pour le client, la plus haute qualité et souci du détail.

Технология Hotech - единственная, способная предложить полную индивидуализацию радиаторов с реализацией по запросу изделий любой формы и размера. Это могут быть радиаторы в одном экземпляре или малые партии, специально созданные для конкретного клиента с максимальным качеством и вниманием к деталям.

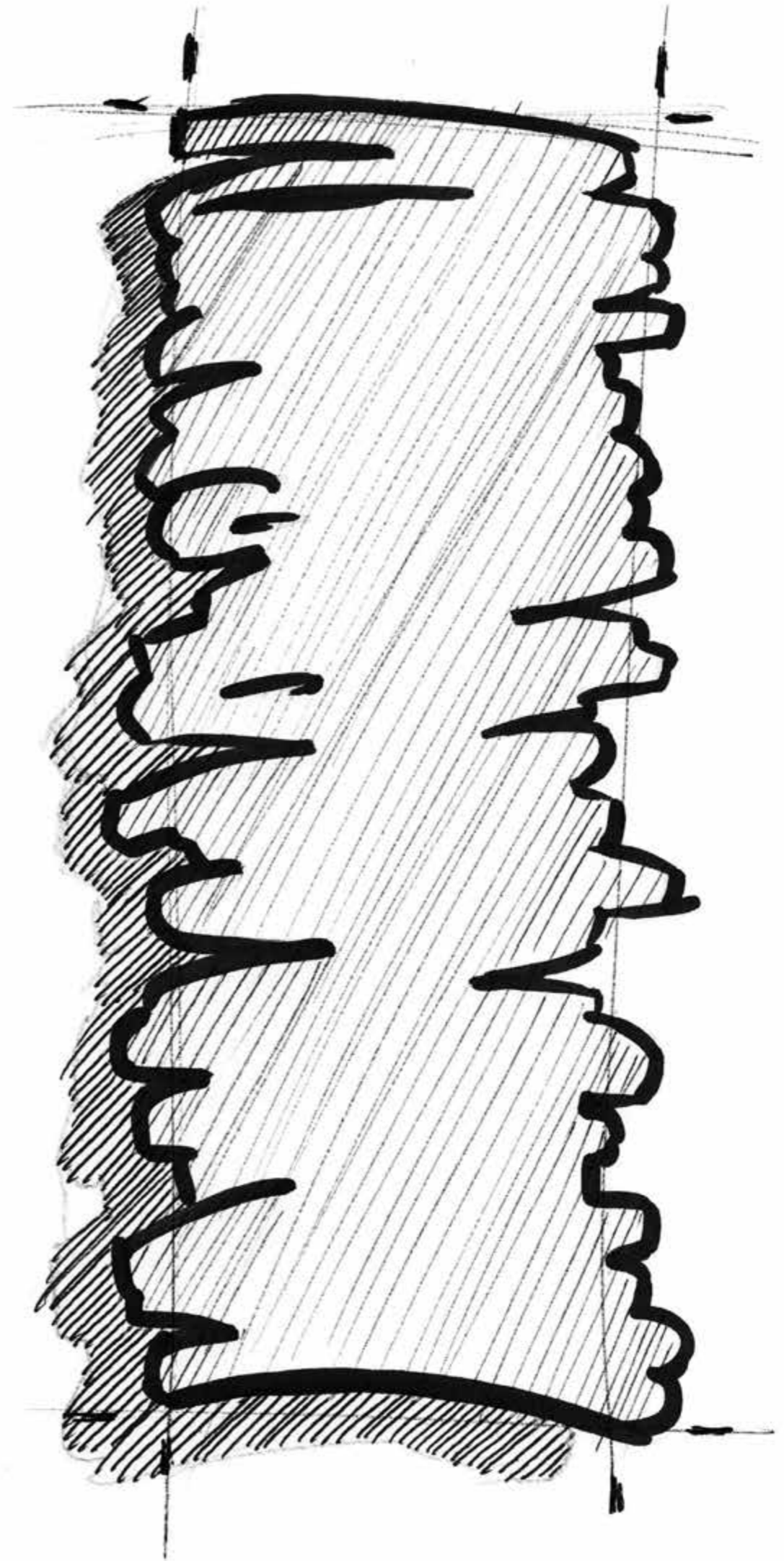

# ENGRAVING

Ogni termoarredo Hotech può essere personalizzato con un'incisione superficiale, colorata in nero, oppure tono su tono.

Every Hotech radiator can be personalized with a superficial engraving that be either black or ton sur ton.

Chaque radiateur décoratif Hotech peut être personnalisé avec une incision superficielle, colorée en noir ou ton sur ton.

Каждый радиатор Hotech может быть оформлен индивидуально посредством поверхностной гравировки, выполненной чёрным цветом или в том же цвете.

28

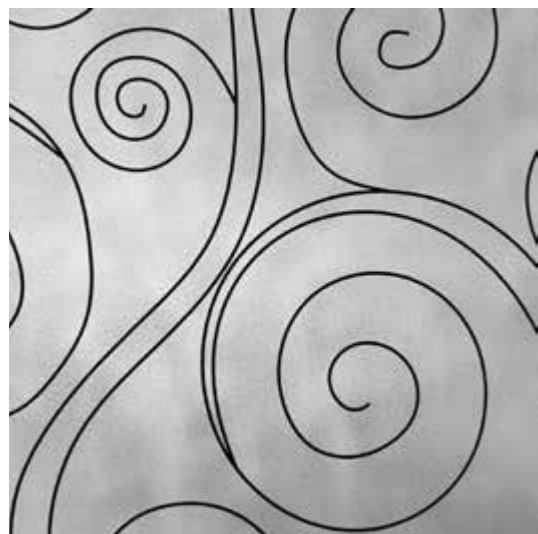

29

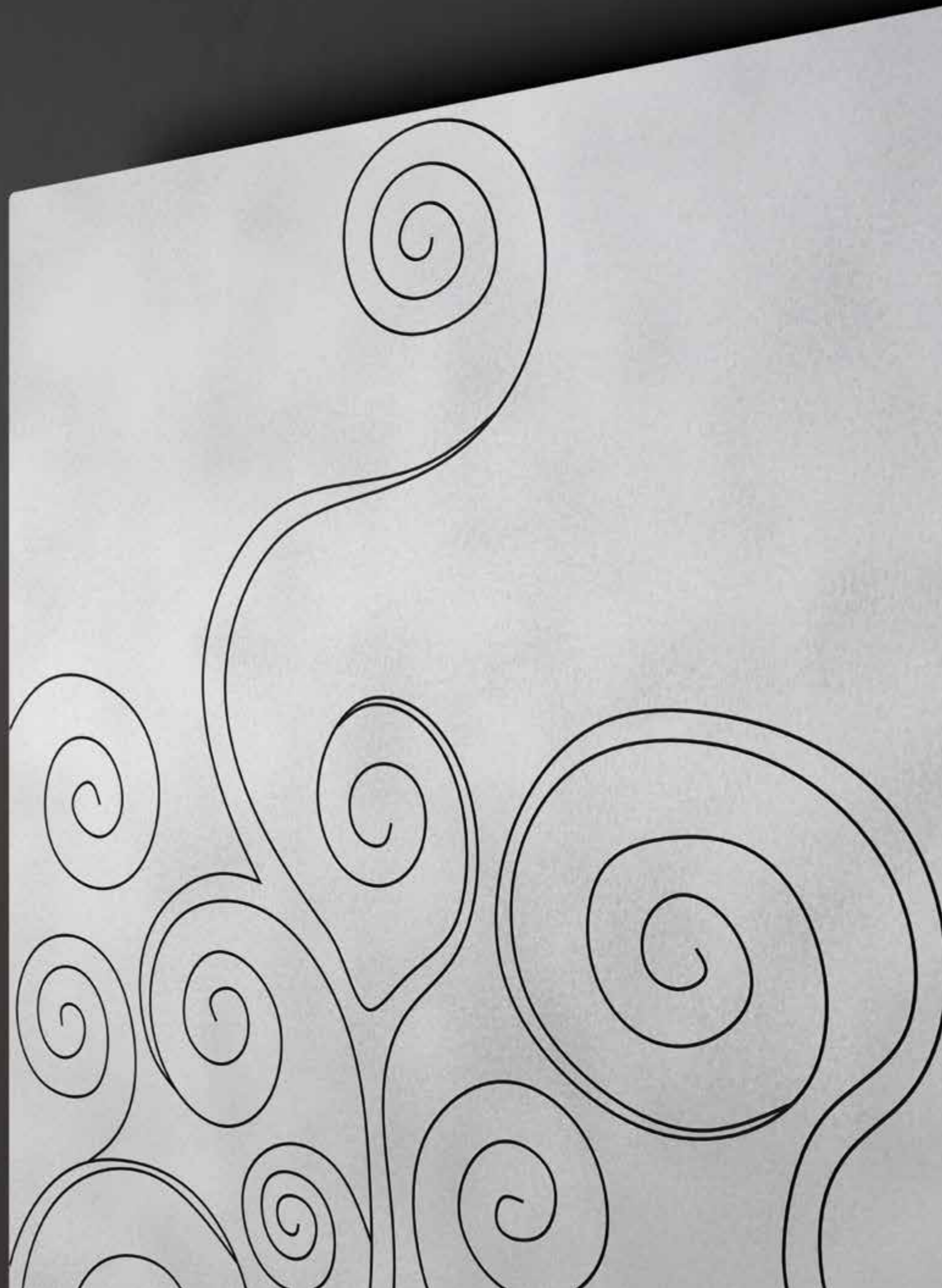

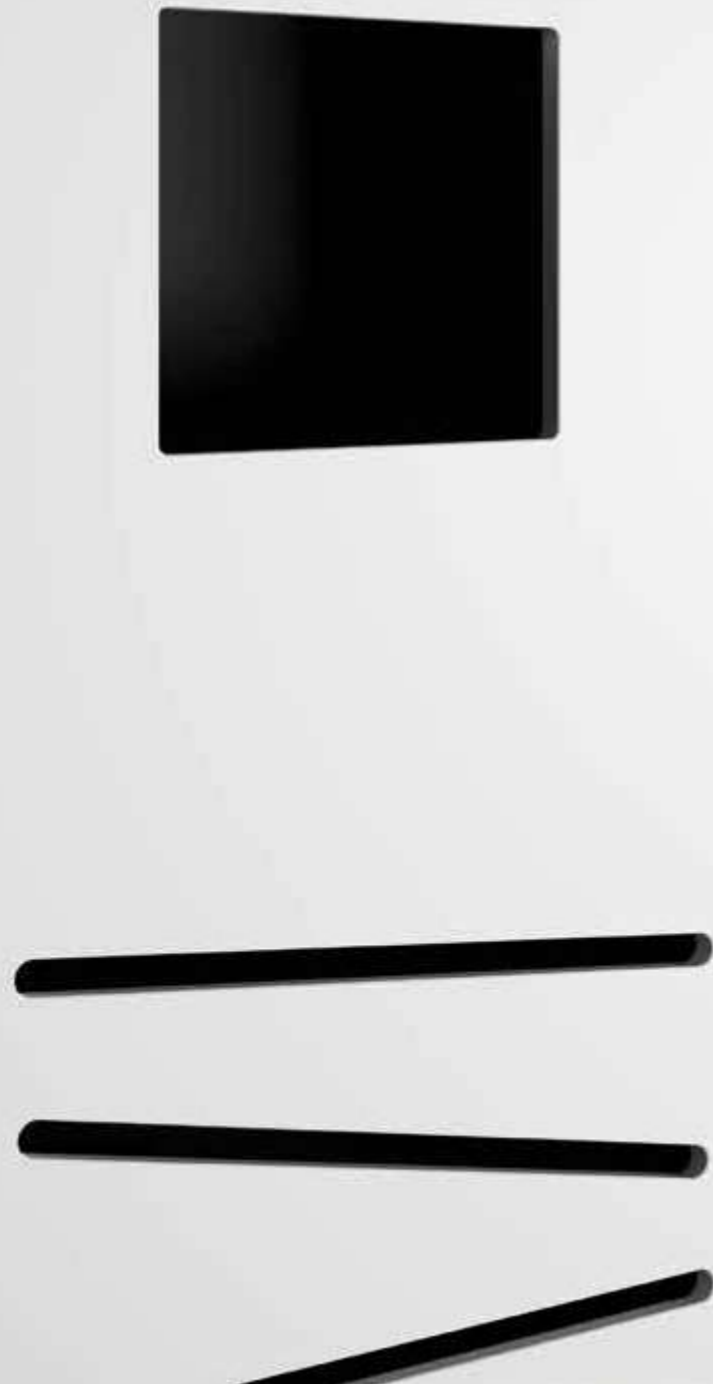

## CUTS AND HOLES

La superficie dei radiatori Hotech può essere modellata a piacimento, aprendo fori passanti, tagli e fresature sagomate, preservando tutte le caratteristiche tecniche e prestazionali del calorifero; sia sulla lastra singola che nella configurazione "Double" a doppia piastra radiante.

The surface of Hotech radiators can be shaped at will, through holes can be drilled, cuts and moulded milling can be made while keeping all the technical features and performance of the radiator unchanged, in the single-plate radiators as well as in the 'double' heating plate configuration.

La surface des radiateurs Hotech peut être façonnée comme désiré, en ouvrant des trous passants, des coupes et des fraisages profilés, en préservant toutes les caractéristiques techniques et de performance du calorifère ; à la fois sur la plaque unique et dans la configuration « Double » à double plaque radiante.

Поверхность радиаторов Hotech может быть смоделирована по желанию, с возможностью создания сквозных отверстий, срезов и фигурных вырезов, с сохранением технических характеристик устройства как на одиночной, так и на двойной панели в конфигурации Double.

# LOGO

full customizaton



32



*Beretti*  
Pavimenti & rivestimenti  
*The sing of style*

*Beretti*  
Pavimenti & rivestimenti  
*The sing of style*

33

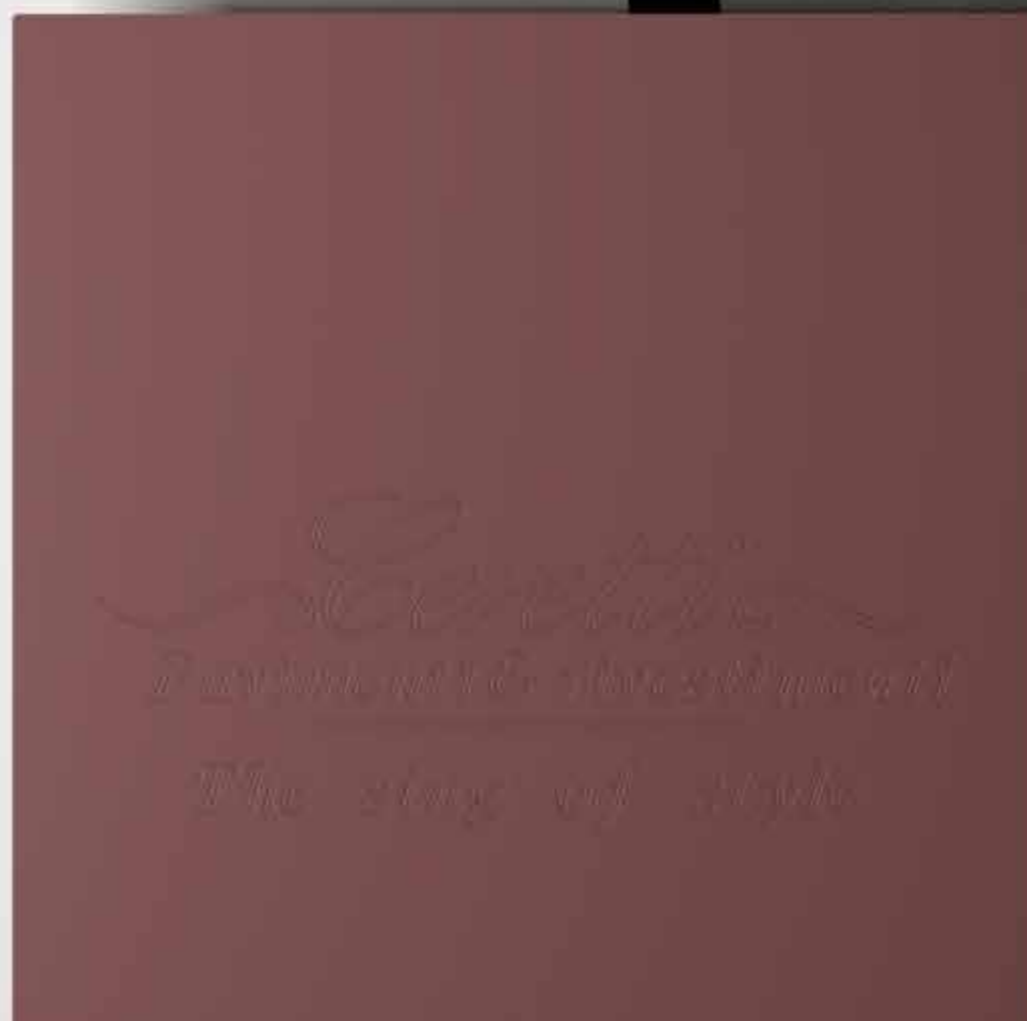

# LED

Uno dei compiti del Design è quello di saper emozionare, raccontare storie e creare atmosfere; per questo motivo Hotech ha pensato ad un ulteriore tocco di stile, prevedendo come optional su tutti i modelli, la possibilità di avere una moderna retroilluminazione led, perfettamente integrata nella struttura.

Design is intended to produce emotions, tell stories and create atmospheres. And that is why Hotech have included another touch of style in their radiators: a modern LED backlight that perfectly blend into the structure comes as an optional feature for all the models.

Une des tâches du Design est de pouvoir exciter, raconter des histoires et créer des ambiances ; pour cette raison Hotech a pensé à une touche supplémentaire de style, offrant en option sur tous les modèles, la possibilité d'avoir un rétro-éclairage LED moderne, parfaitement intégré dans la structure.

Главные задачи дизайна - вызывать эмоции, рассказывать историю и создавать атмосферу. Поэтому Hotech придал дополнительную стилистическую ноту своим изделиям, предусмотрев возможность добавления на всех моделях современной светодиодной подсветки, идеально встроенной в конструкцию.

# POLISHED

STAINLESS STEEL

Una delle finiture più esclusive, applicabile su molti dei termoarredi Hotech è la lavorazione superficiale ad effetto specchiato; ottenuta tramite l'installazione, perfettamente aderente al corpo scaldante, di una lastra d'acciaio inossidabile debitamente trattata e lucidata.

One of the most exclusive finishes that can be applied to many of the Hotech radiators is treating the surface to obtain a mirror effect. This is done by applying a duly treated and polished plate of stainless steel that perfectly adheres to the heating body.

L'une des finitions les plus exclusives, applicable sur de nombreux radiateurs décoratifs Hotech, est le traitement superficiel à effet miroir ; obtenue par l'installation, parfaitement adhérente au corps de chauffe, d'une plaque en acier inoxydable dûment traitée et polie.

Один из самых эксклюзивных вариантов отделки, применяемый во многих моделях радиаторов Hotech, - это поверхностная обработка с зеркальным эффектом, получаемая посредством установки на корпус радиатора плиты из нержавеющей стали, специально обработанной и отполированной.



# LEAF FINISHING



1 : Foglia Oro / Gold Leaf

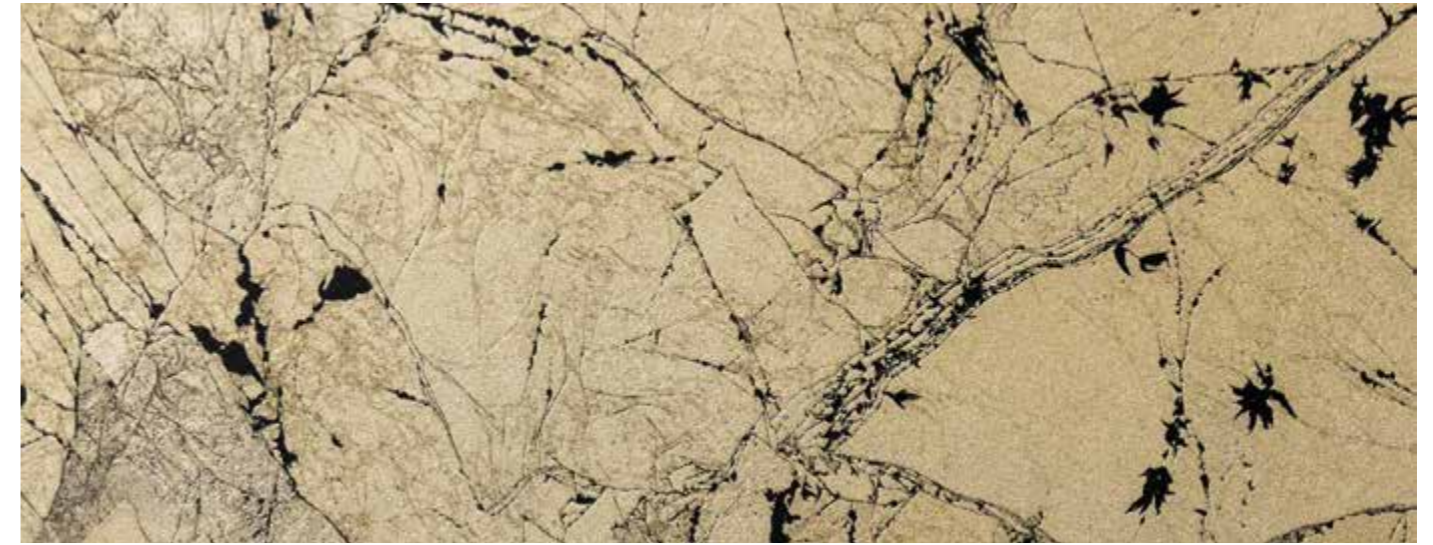

Foglia Oro Antico / Gold Leaf Antique



2 : Foglia Argento / Silver Leaf

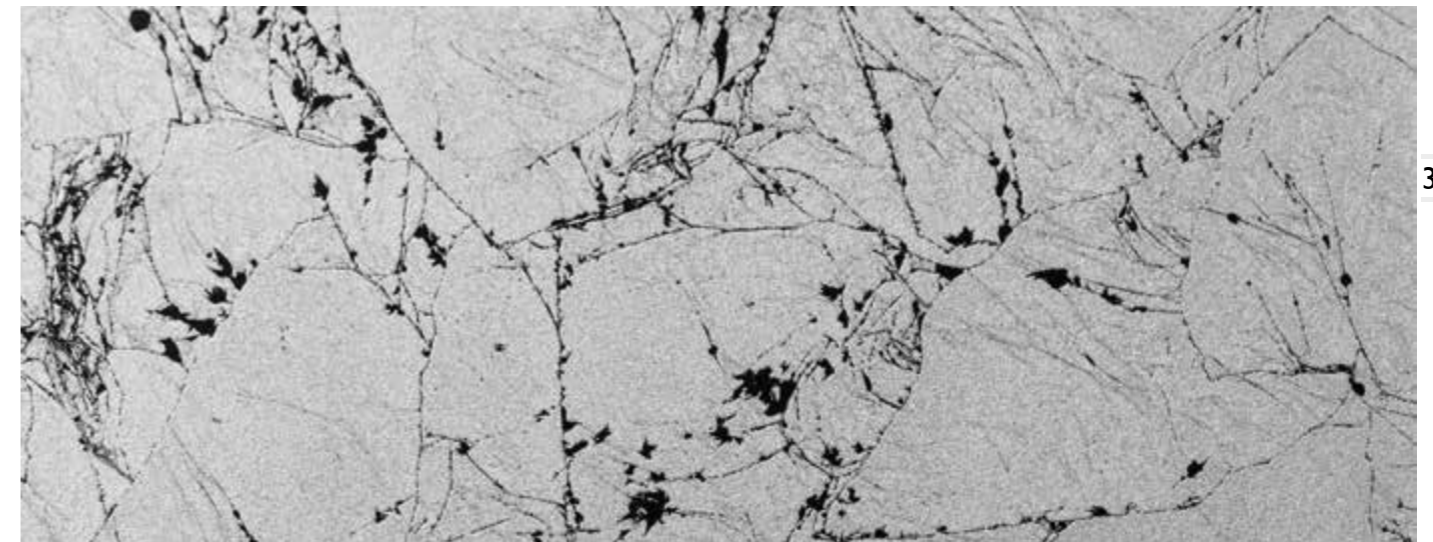

Foglia Argento Antico / Silver Leaf Antique



3 : Foglia Rame / Copper Leaf



Foglia Rame Antico / Copper Leaf Antique

# TECHNICAL FINISHING

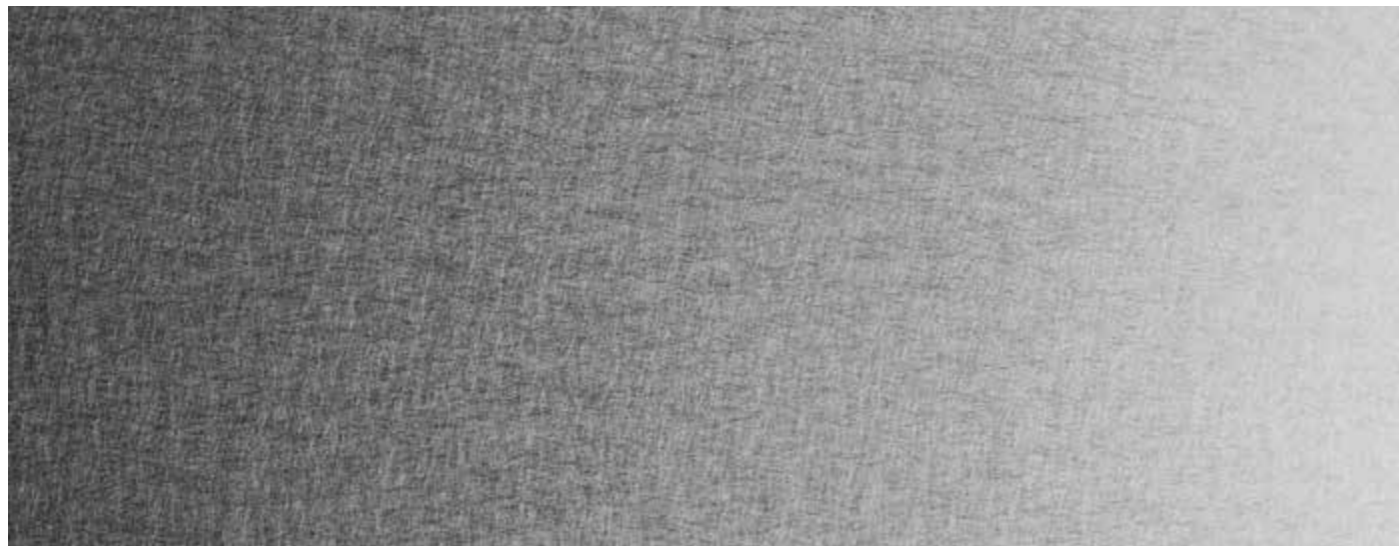

4 : Satinato / Satinized

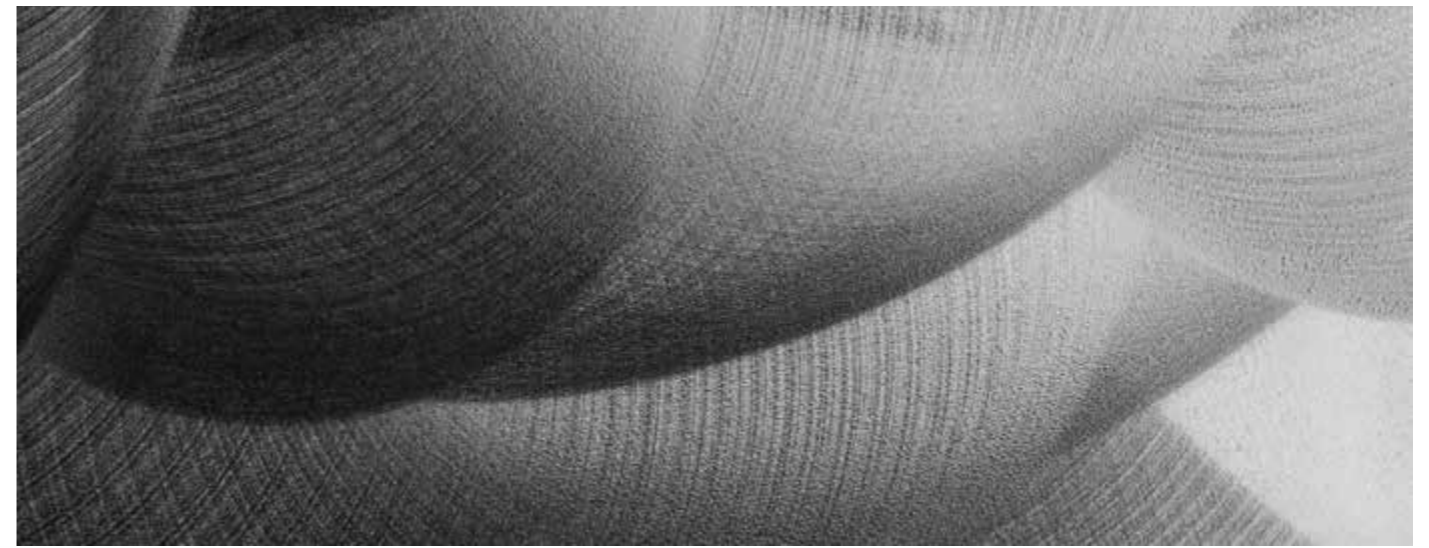

7 : Spazzolato soft / Soft brush



5 : Satinato verticale / Vertical satinized



8 : Finitura Boccioni / Available for Boccioni



6 : Squama / Chip finishing



Corten / Weathering steel

# INDUSTRIAL Alu

Questa finitura nasce da un processo produttivo esclusivo che differisce dallo standard, la particolare lavorazione dona alla superficie una speciale texture ricca di personalità; formata da milioni di piccole incisioni che restituiscono una suggestiva riflessione e una morbida sensazione al tatto. Il materiale conserva tutte le sue caratteristiche primordiali, non essendo lavorato e trattato in alcun modo, al fine di non alterarne le proprietà.

This finish is the result of an exclusive production process that is different from any other standard one. With this innovative process the texture of the surface makes a personality statement; millions of tiny cuts create charming reflections and at the same time are soft to the touch. The original characteristics of the material are left unchanged; since it is not machined or treated in any way to keep all its properties intact.

Cette finition est née par un procédé de fabrication exclusif qui diffère du standard. Le procédé particulier donne une texture spéciale à la surface riche en personnalité ; formé par des millions de petites incisions qui renvoient une réflexion suggestive et un sentiment doux au toucher. Le matériau conserve toutes ses caractéristiques primordiales, n'étant pas usiné et traité de quelque manière, afin de ne pas altérer ses propriétés.

Эта отделка получается посредством эксклюзивного производственного процесса, значительно отличающегося от стандартных. Особая обработка придаёт поверхности необычную текстуру с ярким характером, состоящую из миллионов маленьких надрезов, создающих особый блеск и ощущение мягкости на ощупь. Материал не подвергается никакой особой обработке и сохраняет все свои изначальные характеристики.

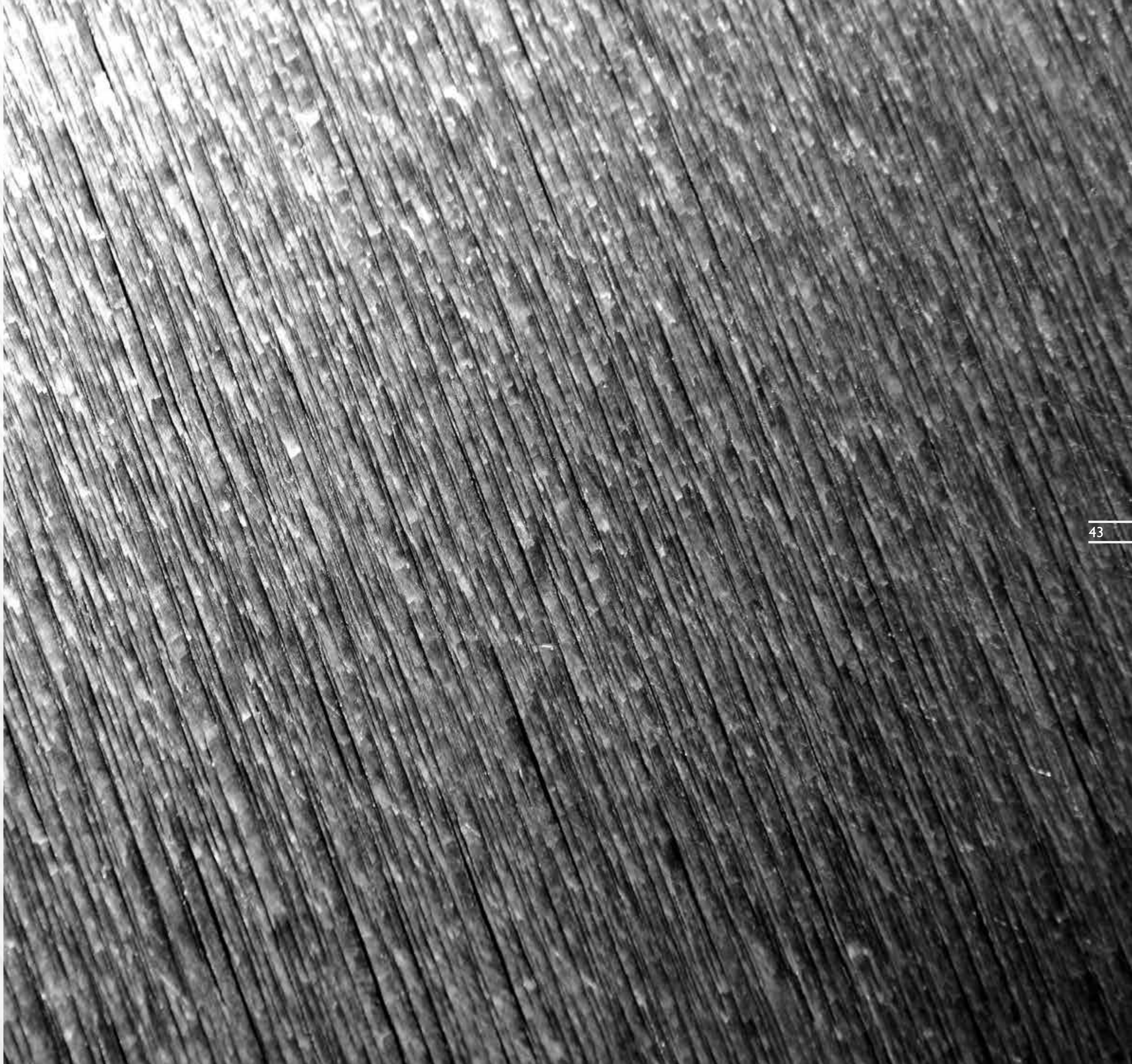

# INDUSTRIAL Alu

44



## SPECIAL FINISHING

Questo particolare materiale è applicabile su tutti i modelli HOTECH.

This particular material is applicable on all HOTECH models.

Ce matériau particulier est applicable sur tous les modèles HOTECH.

Этот конкретный материал применим ко всем моделям HOTECH.



45

# PALETTE RAL



## ENJOY THE SOUND

In ogni momento della vita, la musica non può mancare, colonna sonora di momenti memorabili, ma anche sottofondo del nostro quotidiano; questo ha spinto Hotech a creare "55" il primo radiatore audio mai realizzato. Come ogni oggetto tecnologico che si rispetti, anche questo radiatore ha un solido corpo in alluminio lavorato dal pieno, il suo spessore va assottigliandosi sul perimetro, divenendo quasi inconsistente, come il petalo di un fiore delicato.

Ad arricchire la dotazione hi-tech, del moderno termoarredo 55, un potente speaker, che sfrutta il protocollo di connessione wireless bluetooth e garantisce un'alta definizione, nella riproduzione audio: suono cristallino e bassi potenti.

Basta uno smartphone, un tablet oppure un pc, per collegarsi, senza bisogno di cavi e internet, permettendo così al radiatore di riprodurre la vostra musica preferita; ma anche telefonate, sveglie e note vocali.

Delinea la precisa personalità, di questo termoarredo di design, un anello luminoso che incorona l'altoparlante, accendendo di energia la sua forma primordiale, ogni qual volta un dispositivo, si connette ad esso.

Dans chaque moment de la vie, la musique ne peut pas manquer, la bande sonore des moments mémorables, mais aussi le fond de notre vie quotidienne ; ceci a incité Hotech à créer « 55 », le premier radiateur audio jamais réalisé.

Comme tout objet technologique qui se respecte, ce radiateur également à un corps en aluminium solide usiné en bloc ; son épaisseur s'amincit sur le périmètre, devenant presque insignifiante, comme le pétale d'une fleur délicate.

Pour enrichir la dotation hi-Tech du moderne radiateur décoratif 55, un haut-parleur puissant, qui utilise le protocole de connexion sans fil Bluetooth et qui assure une lecture de haute définition, dans la reproduction audio : son cristallin et basses puissants. Il suffit d'un smartphone, d'une tablette ou d'un pc, pour se connecter, sans besoin de câbles et d'internet, ce qui permet au radiateur de jouer votre musique préférée ; mais aussi des appels téléphoniques, des alarmes et des Mémos vocaux.

Une bague lumineuse qui couronne le haut-parleur souligne la personnalité précise de ce radiateur décoratif, dynamisant sa forme primordiale, chaque fois qu'un appareil s'y connecte.

In every moment of our lives, music has to be there, not only as soundtrack of unforgettable moments, but also as background of our daily life; this is what has motivated Hotech to create "55", the first audio radiator that has ever been made.

As any technological object that inspires respect, this radiator has a solid body made of machined billet aluminium; its thickness fines down over its perimeter, becoming almost intangible, just like the petal of a delicate flower.

To enrich the hi-tech equipment of the modern 55 radiator, there is a powerful speaker featuring the wireless Bluetooth connection protocol that guarantees high definition in audio playing: crystalline sound and powerful bass levels. You only need a smartphone, a tablet or a PC for the connection, without having to use any cable or Internet, thus enabling the radiator to play your favourite music, as well as phone calls, alarms and voice notes.

The outline of the precise personality of this design radiator is traced by a light ring surrounding the speaker, with its primordial shape lighting up every time that a device is connected to it.

Музыка сопровождает нас всю жизнь, становясь саундтреком для памятных событий или фоном для повседневной жизни. Поэтому Hotech создал «55» - первый в мире аудио-радиатор.

Как и каждый уважающий себя радиатор, «55» имеет прочный монолитный алюминиевый корпус, тонкий почти как нежный лепесток цветка.

К высокотехнологичному оснащению радиатора добавлен мощный динамик, использующий беспроводную технологию bluetooth и гарантирующий высококачественный кристально чистый звук и глубокие басы. К динамике можно подсоединиться через смартфон, планшет или компьютер, без необходимости проводного подключения. Таким образом радиатор сможет воспроизводить вашу любимую музыку, а также звонки, напоминания и звуковые сообщения.

Яркий характер этого радиатора дополняет круговая подсветка динамика, включающаяся при подсоединении устройств.

# 55

design by Giovanni Tomasini

50

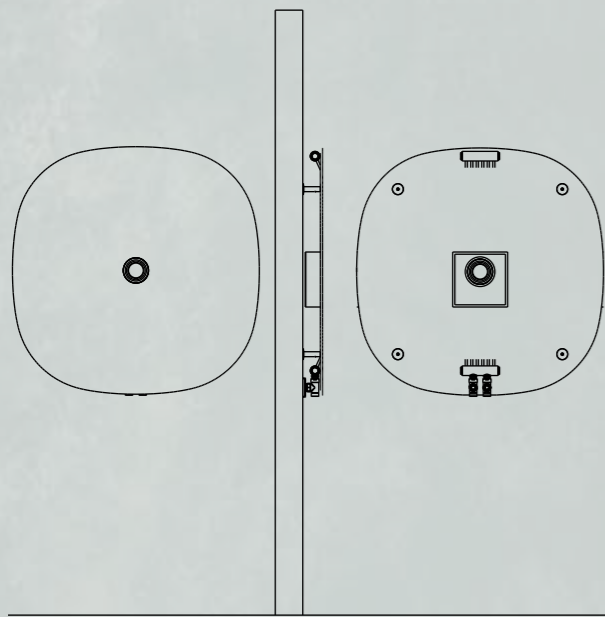

**ELECTRIC VERSION**  
available



**HYDRAULIC VERSION**  
available



**DOUBLE VERSION**  
available



**AUDIO SPEAKER**  
30 watt - bluetooth



**ACCESSORIES**  
pag. 144 - 147



**FINISHING**  
pag. 38 - 45

Le schede tecniche complete sono disponibili sul sito  
[www.hotechdesign.com](http://www.hotechdesign.com)

The complete technical data sheets are available at  
[www.hotechdesign.com](http://www.hotechdesign.com)

Les fiches techniques complètes sont disponibles sur  
[www.hotechdesign.com](http://www.hotechdesign.com)

Полные технические данные доступны на сайте  
[www.hotechdesign.com](http://www.hotechdesign.com)

51





**S**tile, luce e suono, la formula vincente che Hotech ha elaborato, per realizzare termoarredo sul mercato, che si affacci all'universo "smart"; un mondo interconnesso, sempre più "user friendly" e al servizio della persona. Con 55, per la prima volta il calorifero non è più oggetto prettamente "invernale", ma irrinunciabile complemento d'arredo, da sfoggiare e sfruttare tutto l'anno in ogni momento della giornata ed in ogni ambiente della casa; protagonista sia del bagno che della zona living.

Le style, la lumière et le son, la formule gagnante développée par Hotech, pour créer le premier radiateur décoratif sur le marché, qui s'inspire de l'univers « intelligent » ; un monde interconnecté, de plus en plus « convivial » et au service de la personne.

Avec 55, pour la première fois le calorifère n'est plus purement un objet « hivernal », mais une pièce essentielle du mobilier, à exhiber et exploiter tout au long de l'année, à tout moment de la journée et dans chaque pièce de la maison.

Style, light and sound: the winning formula developed by Hotech to produce the first radiator in the market that looks onto the 'smart' universe; an interconnected world that is becoming more and more user friendly and at the service of people.

With 55, this is the first time that the heater is no longer a purely and typically 'winter' object, but rather an essential piece of furniture to be flaunted and enjoyed all year through at any time of the day and in any room of the house.

Стиль, свет и звук - это победная формула, которую использовала компания Hotech для создания первого радиатора на рынке, являющего частью вселенной smart - этого взаимосвязанного мира userfriendly, без которого нам всё сложнее обойтись.

Впервые радиатор стал не только «зимним» предметом, но и незаменимым элементом интерьера, который можно использовать круглый год, в любой момент дня и ночи и в любом помещении.

ANYTIME ANYWHERE

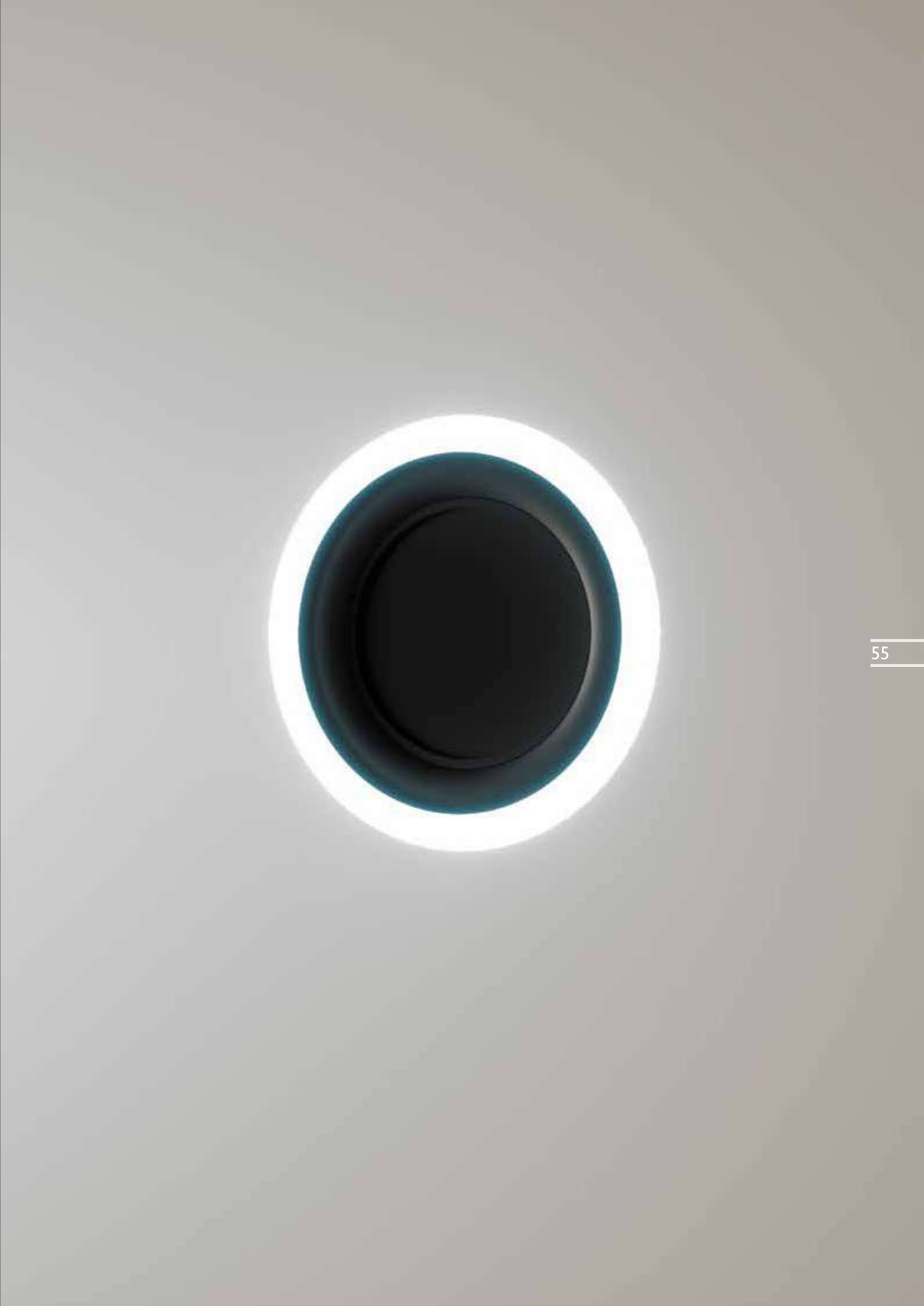
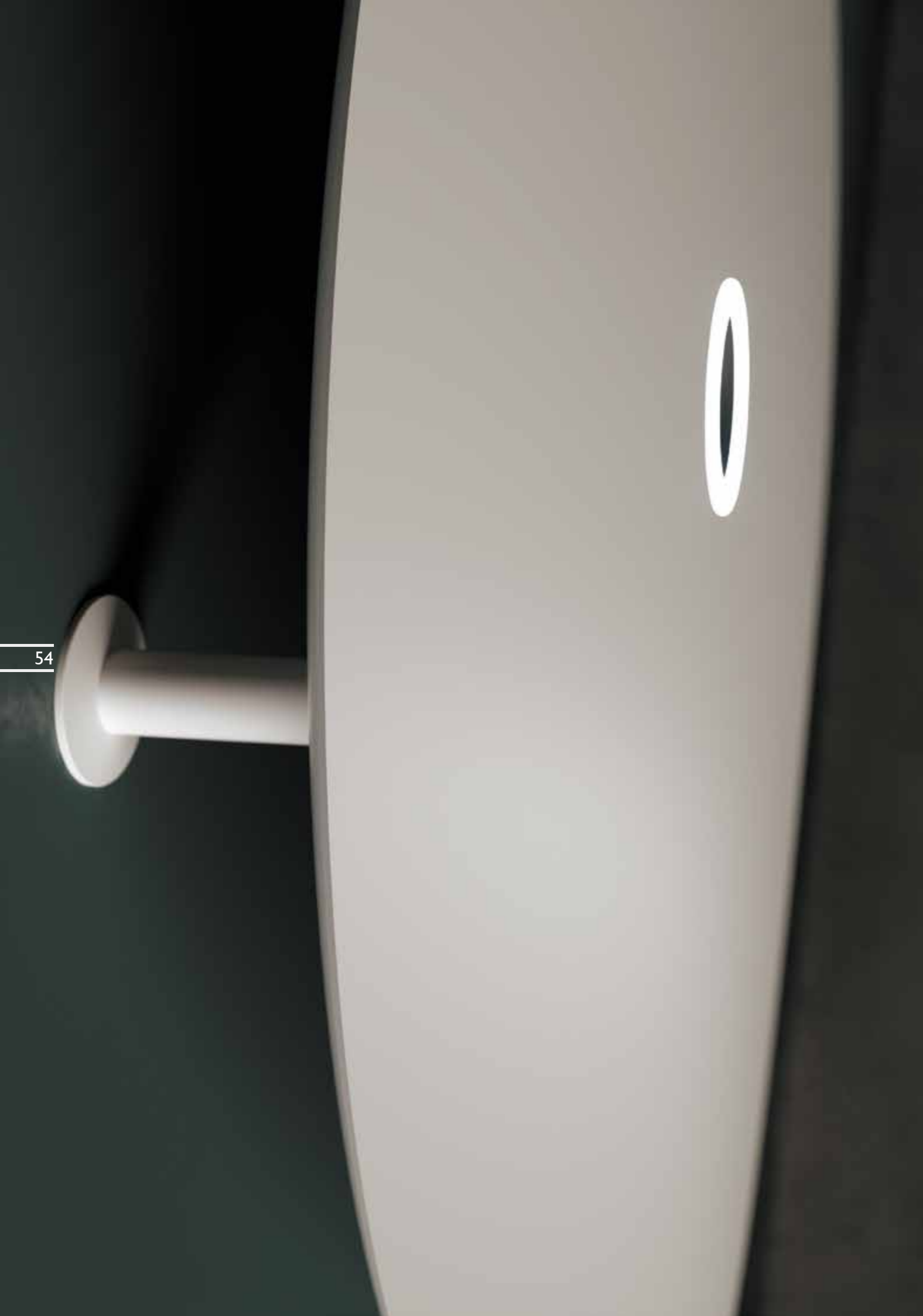

**I**l bagno è la stanza più intima di ogni abitazione, uno spazio consacrato al relax, dove routine e benessere si incontrano, per farci sentire meglio con noi stessi; un'oasi, dove potersi rilassare, occuparsi della cura del corpo e della bellezza personale. Hotech design radiators, propone prodotti d'eccellenza e dalle elevate prestazioni, appositamente studiati per mantenere un alto livello di comfort, in questa zona coinvolta sempre più nel lifestyle quotidiano. Radiatori di qualità, che coniugano efficienza e risparmio energetico, in una visione di sostenibilità globale; prediligendo materiali nobili e certificati, al fine di evitare l'inquinamento indoor e preservare la salute.

Il bagno è tutto questo e anche molto di più, non solo un ambiente dove riscoprire se stessi, ma anche l'unico luogo della casa dove gli ospiti trascorrono del tempo da soli, la camera da bagno è quindi un vero e proprio "status symbol", dove mettere in mostra il proprio gusto personale. Per soddisfare ogni esigenza, Hotech collabora con designer affermati, proponendo soluzioni di alto stile; conciliando lusso, tecnologia e design.

56

La salle de bain est la pièce la plus intime de chaque maison, un espace dédié à la détente, où la routine et le bien-être se rencontrent, pour nous faire sentir mieux dans notre peau ; une oasis, où vous pourrez vous détendre, prendre soin du corps et de la beauté personnelle.

L'Hotech Design Radiators propose des produits d'excellence et de haute performance, spécialement conçus pour maintenir un haut niveau de confort, dans ce domaine de plus en plus impliqué dans le mode de vie quotidien. Des radiateurs de qualité, alliant efficacité et économie d'énergie, dans une vision de soutenabilité globale, en privilégiant des matériaux nobles et certifiés, afin d'éviter la pollution intérieure et préserver la santé.

La salle de bains est tout cela et bien plus, non seulement un environnement pour se redécouvrir, mais aussi le seul endroit dans la maison où les invités passent du temps seuls ; la salle de bain est donc un véritable « symbole de statut social », où montrer votre goût personnel. Pour répondre à tous ces besoins, Hotech collabore avec des designers reconnus, proposant des solutions de haut niveau, en conciliant luxe, technologie et design.

The bathroom is the most intimate room in each house; an area devoted to relax, where routine and well-being meet to make us feel better with ourselves; an oasis where we can relax, and take care of our bodies and of personal beauty.

Hotech Design Radiators offer first-class products characterised by high performance, and which have been specifically studied to maintain a high level of comfort, in this area that constitutes an important part of everyday lifestyle.

Quality radiators that combine efficiency and energy saving, in a global sustainability vision; favouring noble, certified materials in order to avoid indoor pollution and to protect health.

The bathroom is all this and so much more: it is not only a room where we can rediscover ourselves, but also the only place in the house where guests spend time by themselves.

The bathroom is therefore a real 'status symbol' where to show our own personal taste. To meet all needs, Hotech work together with well-known designers, offering stylish solutions; reconciling luxury, technology and design.

Ванная комната - это самое интимное пространство в любой квартире: место для отдыха, где повседневность и релакс встречаются, позволяя нам почувствовать себя лучше. Это оазис, где можно расслабиться и заняться собственным телом и красотой.

Hotechdesignradiators предлагает уникальные изделия с высокими рабочими показателями, созданные специально для поддержания высокого уровня комфорта в этой зоне, всё чаще становящейся показателем стиля жизни. Это качественные радиаторы, сочетающие в себе эффективность и энергосбережение в рамках глобальной идеи экологичности, созданные из благородных сертифицированных материалов, позволяющих избежать загрязнения внутри дома и сохранить здоровье.

Ванная - это не только место для познания себя, но и единственное помещение в доме, где гости могут уединиться. Таким образом ванная комната - это самый настоящий «символ статуса», где хозяин может продемонстрировать собственный вкус. Для удовлетворения любой потребности клиента Hotech сотрудничает с известными дизайнерами, предлагая исключительно стильные решения, сочетающие роскошь, технологию и дизайн.

## BATHROOM & living



57

# FABERGÈ

design by Hotech



58



59

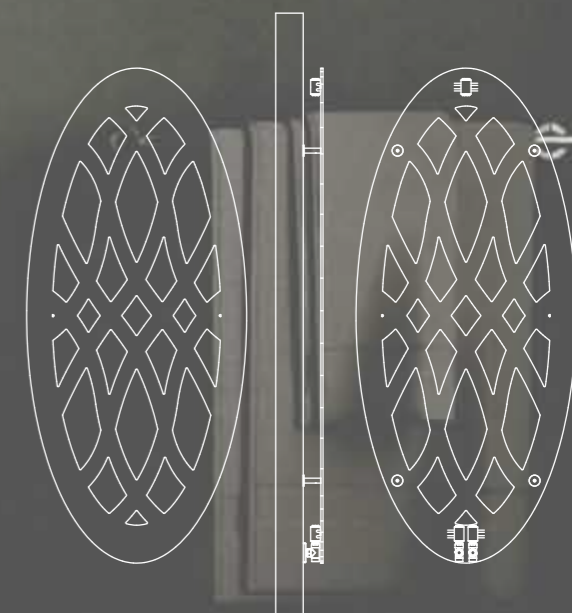

**ELECTRIC VERSION**  
available



**HYDRAULIC VERSION**  
available



**FINISHING**  
pag. 38 - 45



**SPECIAL FINISHING**  
available



**ACCESSORIES**  
pag. 144 - 147

Le schede tecniche complete sono disponibili sul sito  
[www.hotechdesign.com](http://www.hotechdesign.com)

The complete technical data sheets are available at  
[www.hotechdesign.com](http://www.hotechdesign.com)

Les fiches techniques complètes sont disponibles sur  
[www.hotechdesign.com](http://www.hotechdesign.com)

Полные технические данные доступны на сайте  
[www.hotechdesign.com](http://www.hotechdesign.com)

# MONO

design by Hotech

60

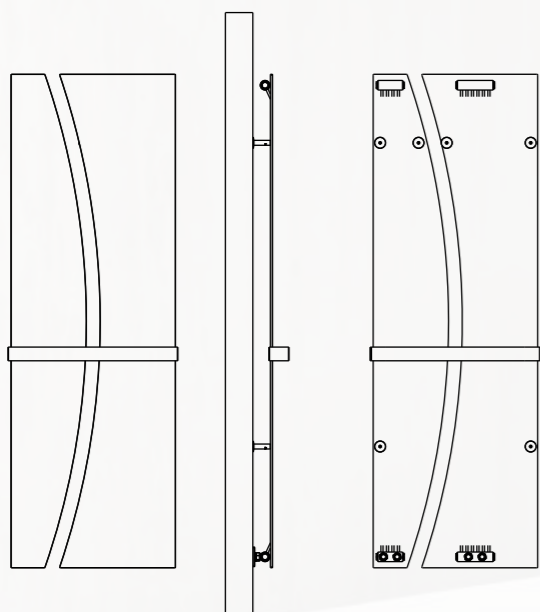

**ELECTRIC VERSION**  
available



**HYDRAULIC VERSION**  
available



**FINISHING**  
pag. 38 - 45



**ACCESSORIES**  
pag. 144 - 147



**SPECIAL FINISHING**  
available



**DOUBLE COLOR**  
available

Le schede tecniche complete sono disponibili sul sito  
[www.hotechdesign.com](http://www.hotechdesign.com)

The complete technical data sheets are available at  
[www.hotechdesign.com](http://www.hotechdesign.com)

Les fiches techniques complètes sont disponibles sur  
[www.hotechdesign.com](http://www.hotechdesign.com)

Полные технические данные доступны на сайте  
[www.hotechdesign.com](http://www.hotechdesign.com)

61



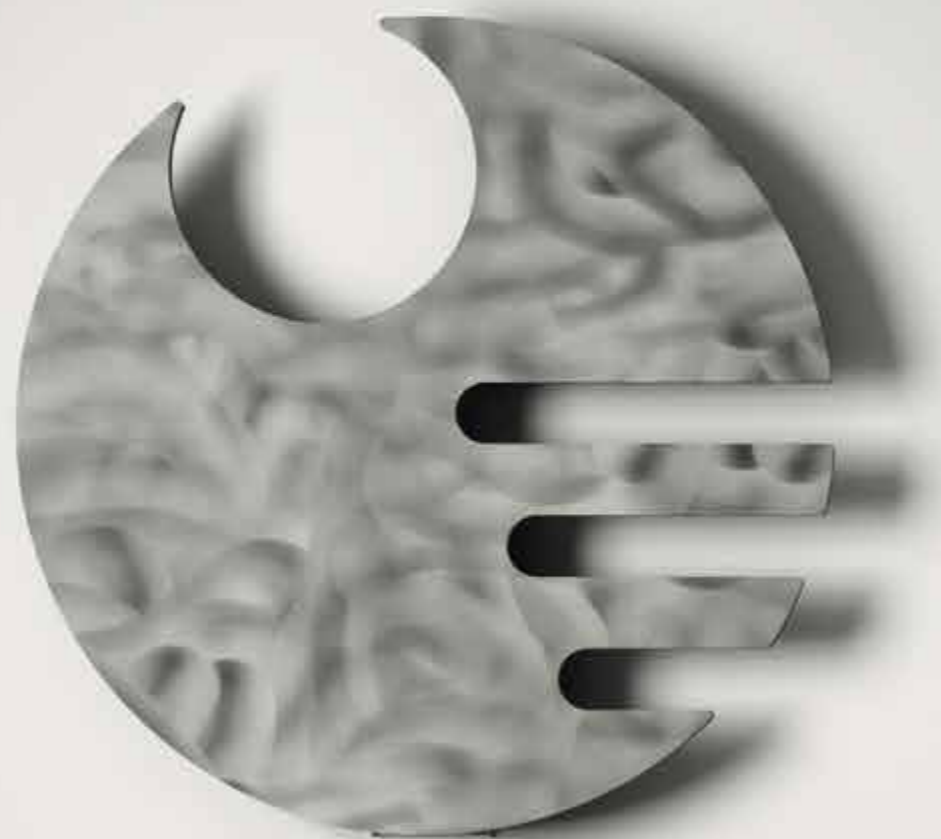

# EILEEN

design by Monica Pilenghi

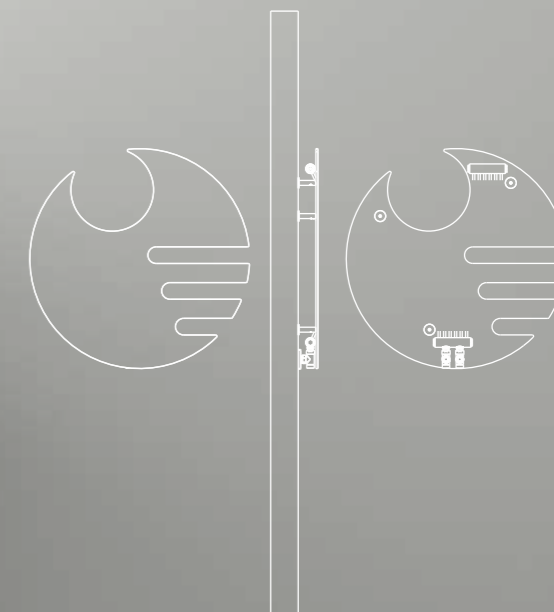

ELECTRIC VERSION  
available



HYDRAULIC VERSION  
available



FINISHING  
pag. 38 - 45



ACCESSORIES  
pag. 144 - 147

Le schede tecniche complete sono disponibili sul sito  
[www.hotechdesign.com](http://www.hotechdesign.com)

The complete technical data sheets are available at  
[www.hotechdesign.com](http://www.hotechdesign.com)

Les fiches techniques complètes sont disponibles sur  
[www.hotechdesign.com](http://www.hotechdesign.com)

Полные технические данные доступны на сайте  
[www.hotechdesign.com](http://www.hotechdesign.com)

# STRIP

design by Mara Giardini, Federica Sandrini

64

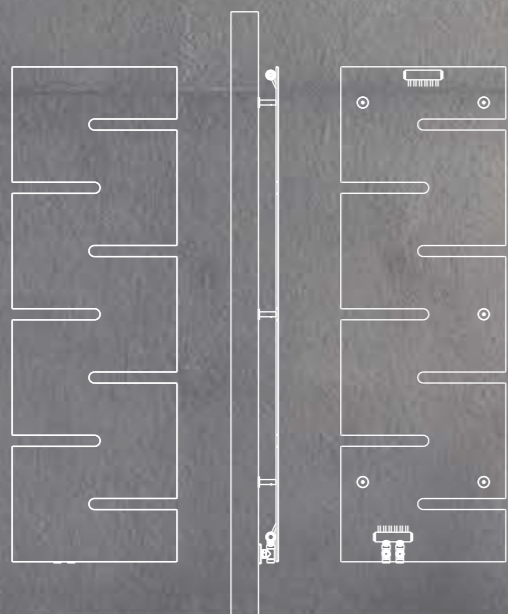

**ELECTRIC VERSION**  
available



**HYDRAULIC VERSION**  
available



**ACCESSORIES**  
pag. 144 - 147



**INTERAXIS**  
center to center variable  
distance



**FINISHING**  
pag. 38 - 45



**SPECIAL FINISHING**  
available

Le schede tecniche complete sono disponibili sul sito  
[www.hotechdesign.com](http://www.hotechdesign.com)

The complete technical data sheets are available at  
[www.hotechdesign.com](http://www.hotechdesign.com)

Les fiches techniques complètes sont disponibles sur  
[www.hotechdesign.com](http://www.hotechdesign.com)

Полные технические данные доступны на сайте  
[www.hotechdesign.com](http://www.hotechdesign.com)

65

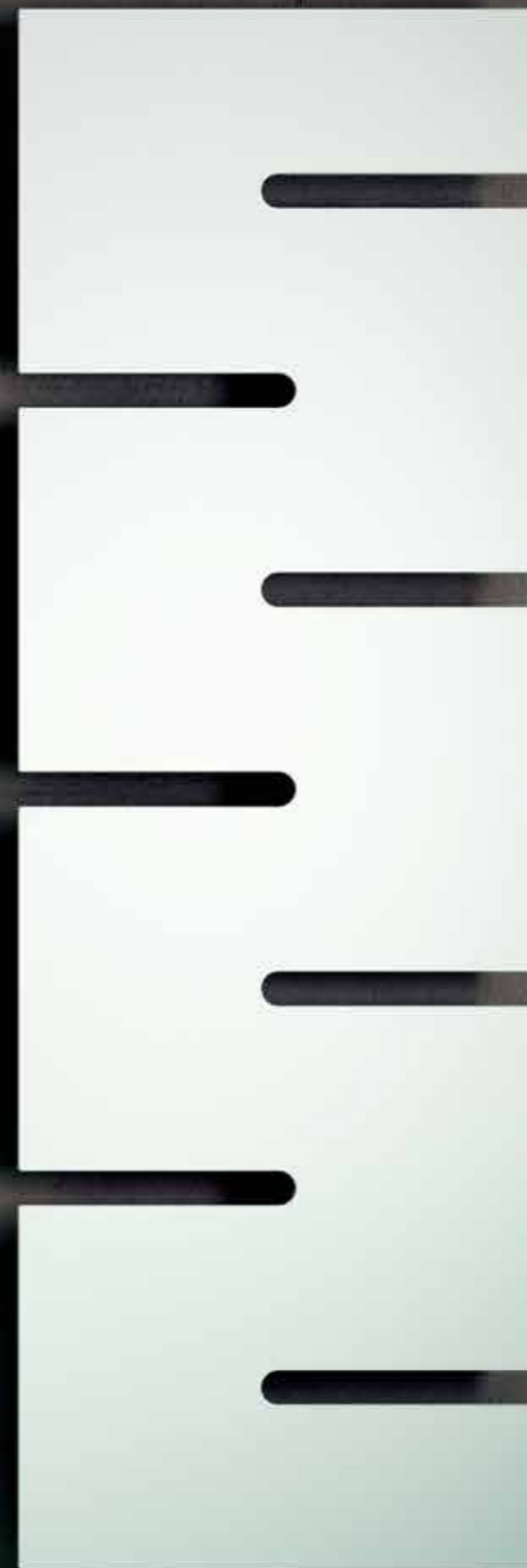



# SOLIS

design by Giovanni Tomasini

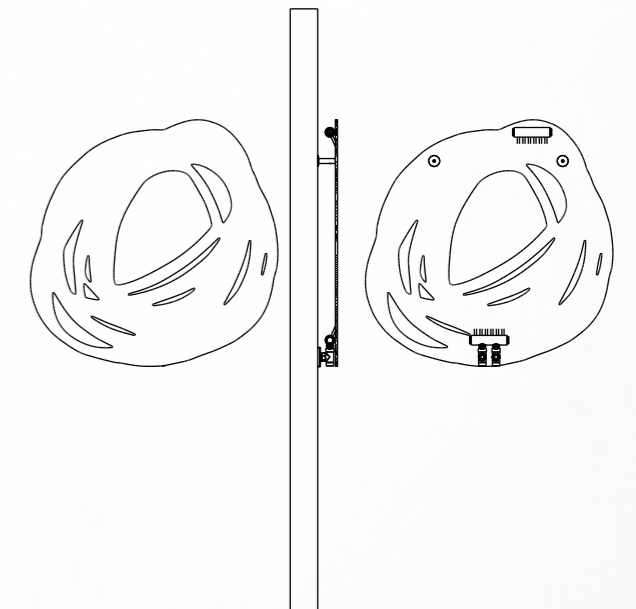

**ELECTRIC VERSION**  
available



**HYDRAULIC VERSION**  
available



**FINISHING**  
pag. 38 - 45



**ACCESSORIES**  
pag. 144 - 147

Le schede tecniche complete sono disponibili sul sito  
[www.hotechdesign.com](http://www.hotechdesign.com)

The complete technical data sheets are available at  
[www.hotechdesign.com](http://www.hotechdesign.com)

Les fiches techniques complètes sont disponibles sur  
[www.hotechdesign.com](http://www.hotechdesign.com)

Полные технические данные доступны на сайте  
[www.hotechdesign.com](http://www.hotechdesign.com)

# ZWART

design by Hotech

68

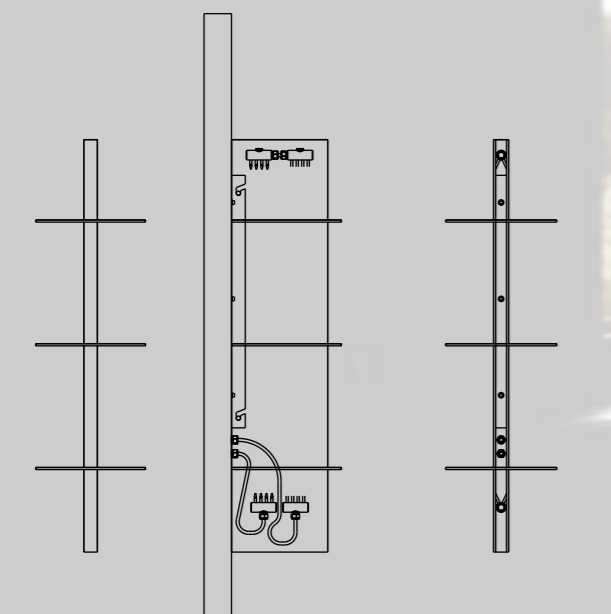

**ELECTRIC VERSION**  
available



**HYDRAULIC VERSION**  
available



**ACCESSORIES**  
pag. 144 - 147



**FINISHING**  
pag. 38 - 45

Le schede tecniche complete sono disponibili sul sito [www.hotechdesign.com](http://www.hotechdesign.com)

The complete technical data sheets are available at [www.hotechdesign.com](http://www.hotechdesign.com)

Les fiches techniques complètes sont disponibles sur [www.hotechdesign.com](http://www.hotechdesign.com)

Полные технические данные доступны на сайте [www.hotechdesign.com](http://www.hotechdesign.com)

69





# FEATHER

design by Monica Pilenghi

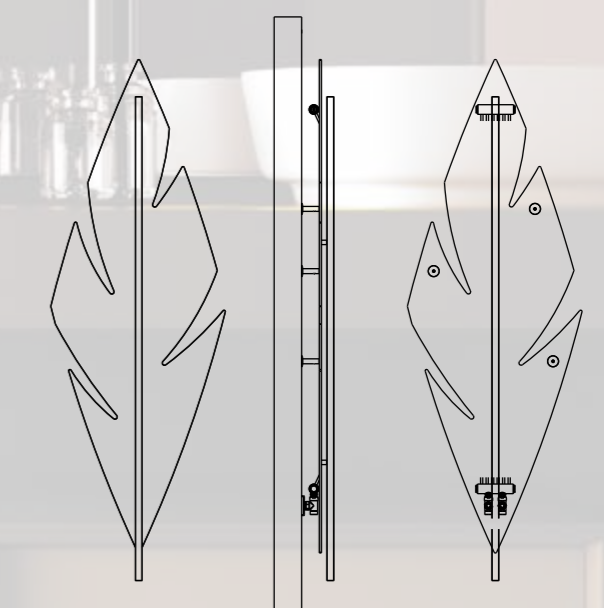

**ELECTRIC VERSION**  
available



**HYDRAULIC VERSION**  
available



**ACCESSORIES**  
pag. 144 - 147



**FINISHING**  
pag. 38 - 45



**SPECIAL FINISHING**  
available

Le schede tecniche complete sono disponibili sul sito [www.hotechdesign.com](http://www.hotechdesign.com)

The complete technical data sheets are available at [www.hotechdesign.com](http://www.hotechdesign.com)

Les fiches techniques complètes sont disponibles sur [www.hotechdesign.com](http://www.hotechdesign.com)

Полные технические данные доступны на сайте [www.hotechdesign.com](http://www.hotechdesign.com)

# MODULE

design by Hotech



72

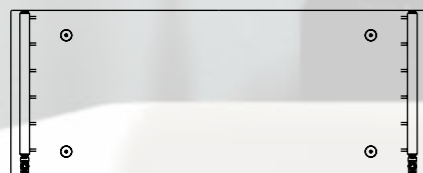
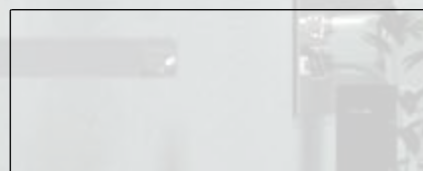

**ELECTRIC VERSION**  
available



**HYDRAULIC VERSION**  
available



**ACCESSORIES**  
pag. 144 - 147



**INTERAXIS**  
center to center variable  
distance



**FINISHING**  
pag. 38 - 45



**SPECIAL FINISHING**  
available



**HYBRID POWER**  
available

Le schede tecniche complete sono disponibili sul sito  
[www.hotechdesign.com](http://www.hotechdesign.com)

The complete technical data sheets are available at  
[www.hotechdesign.com](http://www.hotechdesign.com)

Les fiches techniques complètes sont disponibles sur  
[www.hotechdesign.com](http://www.hotechdesign.com)

Полные технические данные доступны на сайте  
[www.hotechdesign.com](http://www.hotechdesign.com)

73







# LEY

design by Hotech

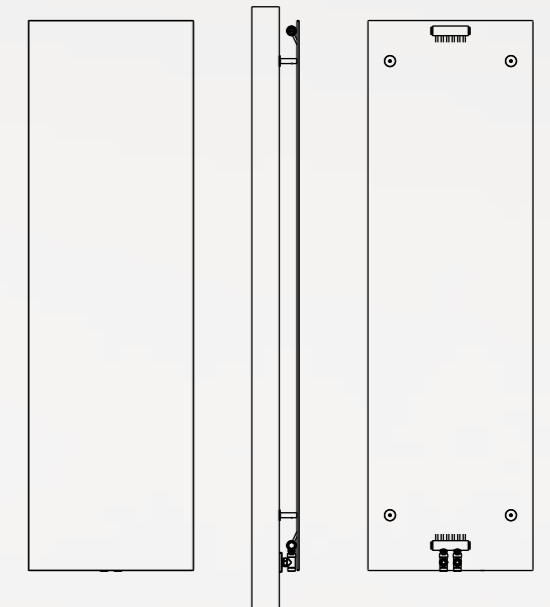
polished INOX



 **ELECTRIC VERSION**  
available

 **HYDRAULIC VERSION**  
available

 **ACCESSORIES**  
pag. 144 - 147

 **INTERAXIS**  
center to center variable  
distance

 **HYBRID POWER**  
available

Le schede tecniche complete sono disponibili sul sito  
[www.hotechdesign.com](http://www.hotechdesign.com)

The complete technical data sheets are available at  
[www.hotechdesign.com](http://www.hotechdesign.com)

Les fiches techniques complètes sont disponibles sur  
[www.hotechdesign.com](http://www.hotechdesign.com)

Полные технические данные доступны на сайте  
[www.hotechdesign.com](http://www.hotechdesign.com)

# ANASTASIA

design by  
Diego Paderno, Arianna Filippini, Federica Ravera

76

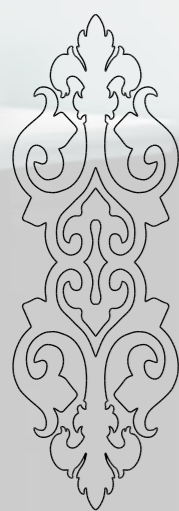

 **ELECTRIC VERSION**  
available

 **HYDRAULIC VERSION**  
available

 **ACCESSORIES**  
pag. 144 - 147

 **FINISHING**  
pag. 38 - 45

Le schede tecniche complete sono disponibili sul sito  
[www.hotechdesign.com](http://www.hotechdesign.com)

The complete technical data sheets are available at  
[www.hotechdesign.com](http://www.hotechdesign.com)

Les fiches techniques complètes sont disponibles sur  
[www.hotechdesign.com](http://www.hotechdesign.com)

Полные технические данные доступны на сайте  
[www.hotechdesign.com](http://www.hotechdesign.com)

77





**I**l colore è importantissimo per un oggetto di design, ha infatti un ruolo primario nella percezione estetica, trasmettendo all'istante emozioni e sensazioni; sui radiatori Hotech gli abbinamenti cromatici sono pressochè illimitati, con la possibilità di riprodurre qualsiasi colore e mixarlo con finiture esclusive e di pregio.

La couleur est très importante pour un objet de design, elle joue un rôle primordial dans la perception esthétique, transmettant instantanément les émotions et les sensations ; sur les radiateurs Hotech, les combinaisons de couleurs sont presque illimitées, avec la possibilité de reproduire n'importe quelle couleur et de la mélanger avec des finitions exclusives et de qualité.

Colour is a factor of utmost importance in a design object; it plays a key role in how objects are perceived aesthetically speaking, since colours transmit feeling and sensations instantly. The combinations of colours in Hotech radiators are endless; almost any colour can be reproduced and also combined with exclusive and fine finishes.

Цвет крайне важен для дизайнерского изделия и имеет ведущую роль в эстетическом восприятии, мгновенно передавая эмоции и ощущения. Радиаторы Hotech доступны практически в бесконечном количестве цветовых вариантов с возможностью воспроизведения любого цвета и использования эксклюзивной и драгоценной отделки.

## TRIADE

design by Hotech

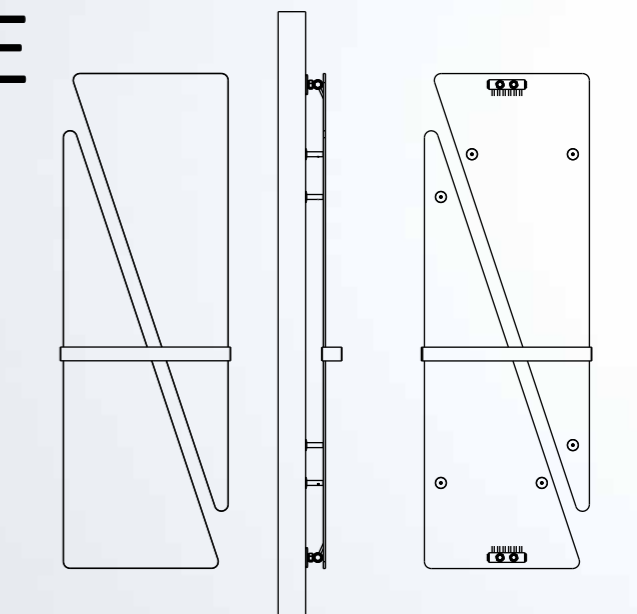

**ELECTRIC VERSION**  
available



**ACCESSORIES**  
pag. 144 - 147



**FINISHING**  
pag. 38 - 45



**HYDRAULIC VERSION**  
available



**DOUBLE COLOR**  
available



**SPECIAL FINISHING**  
available

Le schede tecniche complete sono disponibili sul sito [www.hotechdesign.com](http://www.hotechdesign.com)

The complete technical data sheets are available at [www.hotechdesign.com](http://www.hotechdesign.com)

Les fiches techniques complètes sont disponibles sur [www.hotechdesign.com](http://www.hotechdesign.com)

Полные технические данные доступны на сайте [www.hotechdesign.com](http://www.hotechdesign.com)

# ROMANOV

design by Hotech

80

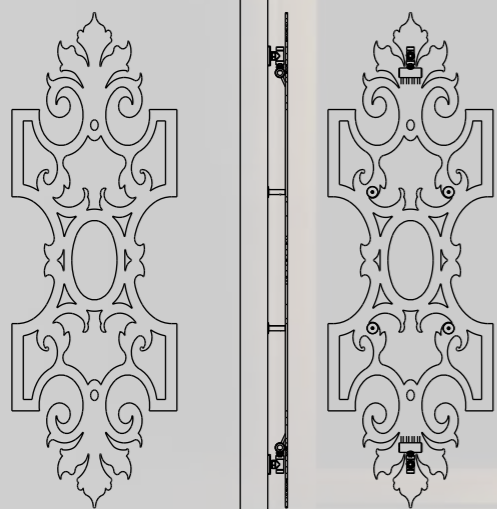

**ELECTRIC VERSION**  
available



**HYDRAULIC VERSION**  
available



**ACCESSORIES**  
pag. 144 - 147



**FINISHING**  
pag. 38 - 45

Le schede tecniche complete sono disponibili sul sito  
[www.hotechdesign.com](http://www.hotechdesign.com)

The complete technical data sheets are available at  
[www.hotechdesign.com](http://www.hotechdesign.com)

Les fiches techniques complètes sont disponibles sur  
[www.hotechdesign.com](http://www.hotechdesign.com)

Полные технические данные доступны на сайте  
[www.hotechdesign.com](http://www.hotechdesign.com)



81

**L**a doratura con foglia oro è una tecnica antica di decorazione ornamentale, largamente utilizzata in passato per impreziosire oggetti ed opere d'arte, ricoprendole con un sottile strato d'oro. Hotech ha recuperato e riposizionato in chiave contemporanea questa preziosa finitura superficiale, che richiede tutt'oggi l'abile maestria di un artigiano specializzato; al fine di investire con luce dorata i suoi pezzi migliori.

La foglia si presenta come la finitura di maggior prestigio in assoluto; una tradizione antica di millenni, che Hotech continua a fedelmente a tramandare, ma che è riuscita addirittura a migliorare. La medesima cura ed attenzione, sono dedicate anche ai rivestimenti alternativi, in foglia argento e foglia rame; che trovano una perfetta collocazione in contesti stilistici moderni, dov'è comunque apprezzata, l'impareggiabile qualità artigianale e artistica del rivestimento.

Un termoarredo con finitura in foglia, rappresenta la massima espressione del "luxury design"; un complemento d'arredo destinato a mantenere e accrescere, il suo valore nel tempo; uno status symbol che eleva di livello ogni ambiente e architettura.

82

La dorure avec feuille d'or est une technique ancienne de décoration ornamentale, largement utilisée dans le passé pour embellir des objets et des œuvres d'art, en les recouvrant d'une fine couche d'or. Hotech a récupéré et repositionné dans une touche contemporaine cette finition de surface précieuse, qui nécessite encore de l'habileté d'un artisan qualifié ; afin d'investir ses meilleures pièces avec la lumière dorée. La feuille se présente comme la finition la plus précieuse de tous les temps : une tradition millénaire ancienne, que Hotech continue de transmettre fidèlement, mais qu'il a même réussi à améliorer.

Le même soin et la même attention sont également consacrés aux revêtements alternatifs, en feuille d'argent et feuille de cuivre ; qui trouvent une collocation parfaite dans des contextes stylistiques modernes, où est cependant appréciée, la qualité artisanale et artistique incomparable du revêtement. Un radiateur décoratif avec finition en feuille, représente la plus haute expression du « design de luxe » ; un meuble conçu pour maintenir et augmenter sa valeur au fil du temps, un symbole de statut social qui élève chaque environnement et architecture de niveau.

Gilding with gold leaf is an ancient ornamental decoration technique that has been widely used in the past to embellish objects and works of art, coating them with a thin gold layer. Hotech have recovered and revisited with a contemporary approach this precious superficial finish, which – to this day – requires the skilful craftsmanship of a specialised artisan; in order to confer golden light on their best pieces.

The leaf is presented as the absolutely most prestigious finish; an ancient tradition dating back to millenniums ago, which Hotech faithfully continue handing down, but which could also be improved.

The same care and attention are also devoted to alternative coatings made of silver leaf and copper leaf, which can be perfectly used in modern style contexts, in which the matchless artisan and artistic quality of the coating is still highly appreciated.

A radiator with leaf finish represents the ultimate expression of 'luxury design'; a piece of furniture destined to maintain and increase its value over time; a status symbol that raises the level of any room and architecture.

Позолота с использованием листового золота - это старинная техника орнаментального декорирования, широко использовавшаяся для украшения предметов и художественных произведений посредством покрытия их тонким слоем золота. Hotech восстановила и пересмотрела в современном ключе это драгоценное покрытие, для нанесения которого по сей день требуется высокое мастерство, и использовала его для декорирования своих лучших изделий. Листовое золото - это наиболее престижная отделка из всех возможных: это традиция с тысячелетней историей, которую Hotech продолжает в точности воспроизводить и передавать и которую даже удалось улучшить. Столь же высокое внимание уделяется и альтернативным покрытиям - листовому серебру и меди, идеально подходящим к современным помещениям, где ценится высокое качество и художественность оформления.

Радиатор с листовым покрытием представляет собой высшее проявление дизайна класса «люкс» - это предмет интерьера, который с годами становится всё ценнее и превращается в символ статуса, обогащающий любой интерьер.

## LEAF FINISHING

83

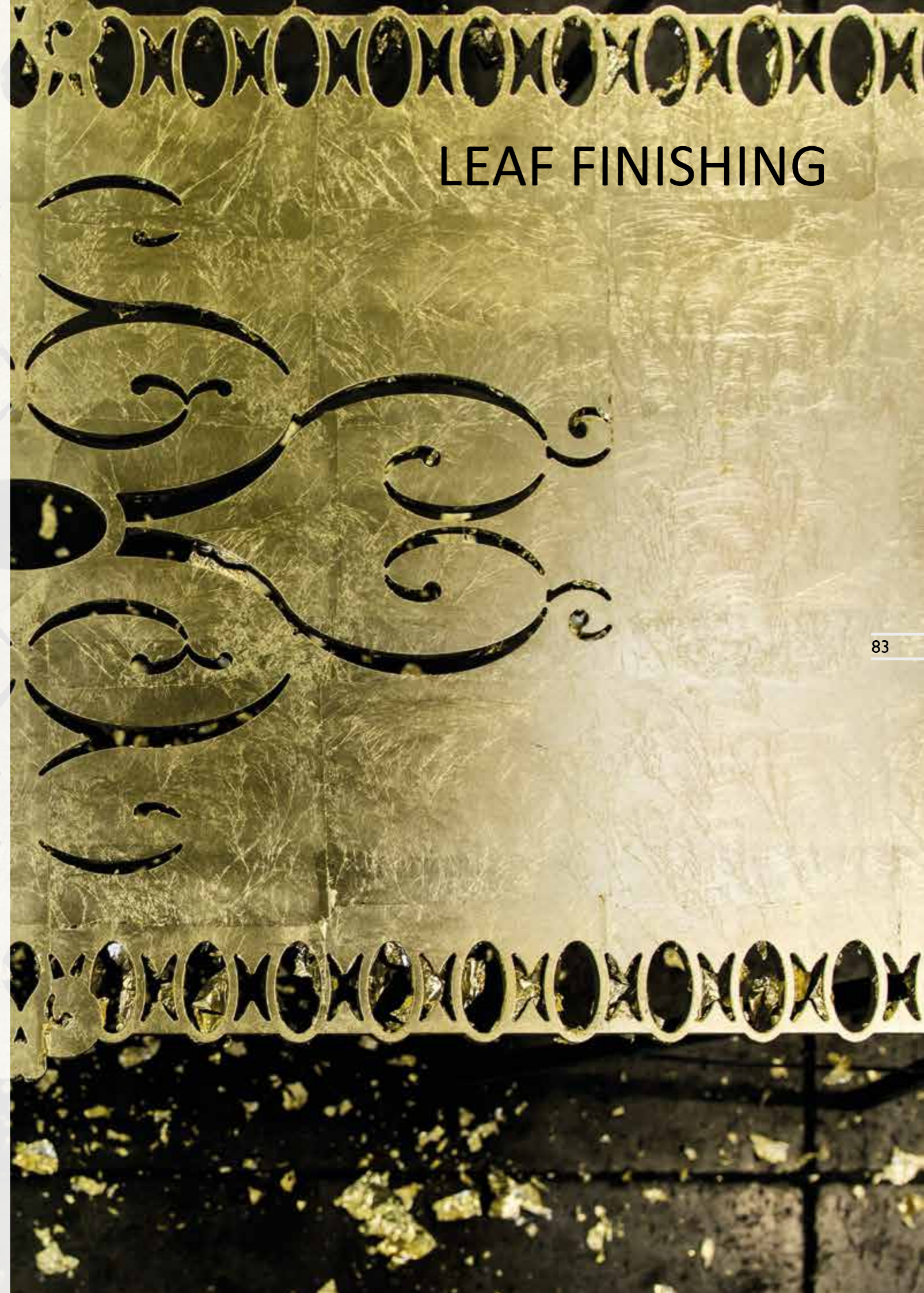

# VASARI

design by Hotech

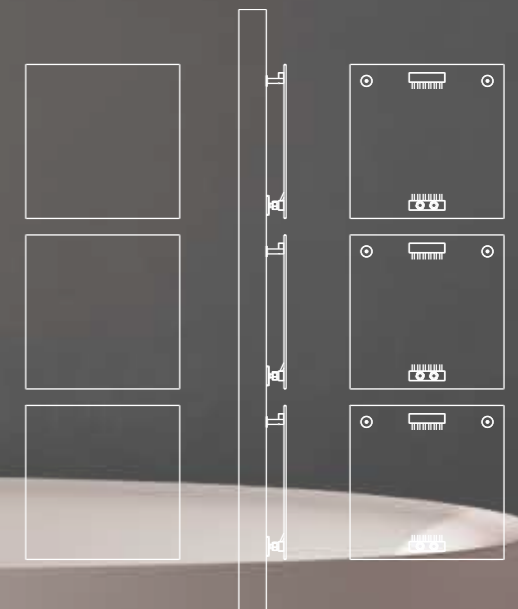

**ELECTRIC VERSION**  
available



**ACCESSORIES**  
pag. 144 - 147



**FINISHING**  
pag. 38 - 45



**HYDRAULIC VERSION**  
available



**DOUBLE COLOR**  
available



**SPECIAL FINISHING**  
available

Le schede tecniche complete sono disponibili sul sito  
[www.hotechdesign.com](http://www.hotechdesign.com)

The complete technical data sheets are available at  
[www.hotechdesign.com](http://www.hotechdesign.com)

Les fiches techniques complètes sont disponibles sur  
[www.hotechdesign.com](http://www.hotechdesign.com)

Полные технические данные доступны на сайте  
[www.hotechdesign.com](http://www.hotechdesign.com)





# VASILY

design by Federico Guastaroba



 **ELECTRIC VERSION**  
available

 **HYDRAULIC VERSION**  
available

 **FINISHING**  
pag. 38 - 45

 **ACCESSORIES**  
pag. 144 - 147

Le schede tecniche complete sono disponibili sul sito  
[www.hotechdesign.com](http://www.hotechdesign.com)

The complete technical data sheets are available at  
[www.hotechdesign.com](http://www.hotechdesign.com)

Les fiches techniques complètes sont disponibles sur  
[www.hotechdesign.com](http://www.hotechdesign.com)

Полные технические данные доступны на сайте  
[www.hotechdesign.com](http://www.hotechdesign.com)



# DAVID

design by Hotech



ELECTRIC VERSION  
available



FINISHING  
pag. 38 - 45



HYDRAULIC VERSION  
available

# EVA

design by Federico Guastaroba



ELECTRIC VERSION  
available



FINISHING  
pag. 38 - 45



HYDRAULIC VERSION  
available

Le schede tecniche complete sono disponibili sul sito  
[www.hotechdesign.com](http://www.hotechdesign.com)

The complete technical data sheets are available at  
[www.hotechdesign.com](http://www.hotechdesign.com)

Les fiches techniques complètes sont disponibles sur  
[www.hotechdesign.com](http://www.hotechdesign.com)

Полные технические данные доступны на сайте  
[www.hotechdesign.com](http://www.hotechdesign.com)



# DUAL

design by Hotech



**ELECTRIC VERSION**  
available



**ACCESSORIES**  
pag. 144 - 147



**FINISHING**  
pag. 38 - 45



**HYDRAULIC VERSION**  
available



**DOUBLE COLOR**  
available



**SPECIAL FINISHING**  
available

Le schede tecniche complete sono disponibili sul sito  
[www.hotechdesign.com](http://www.hotechdesign.com)

The complete technical data sheets are available at  
[www.hotechdesign.com](http://www.hotechdesign.com)

Les fiches techniques complètes sont disponibles sur  
[www.hotechdesign.com](http://www.hotechdesign.com)

Полные технические данные доступны на сайте  
[www.hotechdesign.com](http://www.hotechdesign.com)

Le schede tecniche complete sono disponibili sul sito  
[www.hotechdesign.com](http://www.hotechdesign.com)  
The complete technical data sheets are available at  
[www.hotechdesign.com](http://www.hotechdesign.com)  
Les fiches techniques complètes sont disponibles sur  
[www.hotechdesign.com](http://www.hotechdesign.com)  
Полные технические данные доступны на сайте  
[www.hotechdesign.com](http://www.hotechdesign.com)



**BAUHAUS**  
design by Federico Guastaroba



**ELECTRIC VERSION**  
available



**HYDRAULIC VERSION**  
available



**HYBRID POWER**  
available



**INTERAXIS**  
center to center variable  
distance



**FINISHING**  
pag. 38 - 45



**SPECIAL FINISHING**  
available

# CAVE ADSUM

design by Federico Guastaroba



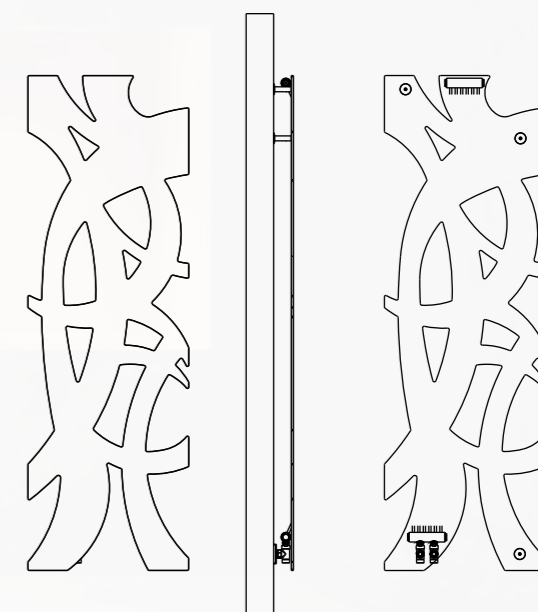

94

95



 **ELECTRIC VERSION**  
available

 **HYDRAULIC VERSION**  
available

 **FINISHING**  
pag. 38 - 45

 **ACCESSORIES**  
pag. 144 - 147

Le schede tecniche complete sono disponibili sul sito  
[www.hotechdesign.com](http://www.hotechdesign.com)

The complete technical data sheets are available at  
[www.hotechdesign.com](http://www.hotechdesign.com)

Les fiches techniques complètes sont disponibles sur  
[www.hotechdesign.com](http://www.hotechdesign.com)

Полные технические данные доступны на сайте  
[www.hotechdesign.com](http://www.hotechdesign.com)

## LIVING & bathroom

**I**l salotto è la parte della casa dove si passa più tempo con la famiglia e dove si accolgono gli ospiti; vi si può leggere un libro, ascoltare musica, guardare la tv, pranzare o più semplicemente rilassarsi. Inutile dire che il Living deve essere curato in ogni minimo dettaglio affinché si trasformi in una zona da vivere e da sfoggiare: confortevole ma anche ricca di stile.

I termoarredi Hotech, sono pensati per chi non si accontenta di un comune calorifero, ma è alla ricerca di un pezzo che possa sposare il "total living" della casa, interpretando le più attuali e valide tendenze del lifestyle contemporaneo, con modelli che vanno dal minimal moderno, fino al classico barocco, per soddisfare ogni gusto del cliente.

Chi sceglie Hotech design radiators, può avere anche prodotti "full custom", ovvero termoarredi personalizzati in ogni minimo dettaglio, nelle dimensioni, nella forma e nel colore; con disegni, incisioni e finiture esclusive.

Il termoarredo di lusso firmato Hotech non è solo estetica, ma anche qualità dei materiali, tecnologia ed ecologia; oggetti progettati per garantire il massimo comfort nel pieno rispetto dell'ambiente e della persona.

Le salon c'est la partie de la maison où l'on passe plus de temps avec sa famille et où on accueille ses invités ; on peut y lire un livre, écouter de la musique, regarder la télévision, déjeuner ou simplement se détendre. Inutile de dire que le Living doit être soigné dans les moindres détails pour qu'il devienne un espace à vivre et à montrer : confortable mais aussi riche en style.

Les radiateurs décoratifs de design Hotech sont conçus pour vous ; pour ceux qui ne se contentent pas d'un chauffage banal, mais qui recherchent une pièce qui peut épouser la «vie totale» de la maison; modèles et des solutions qui interprètent les tendances les plus actuelles et valables du style de vie contemporain, avec des modèles allant du minimalisme moderne au baroque classique, pour satisfaire tous les goûts du client. Qui choisit Hotech Design Radiators, peut aussi avoir des produits « full custom », c'est-à-dire des radiateurs décoratifs personnalisés dans les moindres détails, dans les dimensions, dans la forme et dans la couleur ; avec des dessins, des estampes et des finitions exclusives. Le radiateur décoratif de luxe signé Hotech est non seulement esthétique, mais aussi qualité des matériaux, technologie et écologie ; des objets conçus pour garantir un maximum de confort tout en respectant l'environnement et la personne.

The living-room is the area of the house where we spend time with our family and where guests are received; there, we can read a book, listen to music, watch TV, have lunch or simply relax. It goes without saying that the living-room must be taken care of in every little detail so that it turns into an area to be enjoyed and to be flaunted: comfortable but also rich in style.

The radiators designed by Hotech have been specially thought for you; for those who do not content themselves with a regular radiator, but who are rather searching for a piece that can go well with the "total living" of the house; models and solutions that interpret the latest, most valid trends of contemporary lifestyle, with options ranging from modern minimalist models to classical baroque style, in order to meet all customers' tastes.

Those who choose Hotech Design Radiators can also have full-custom products, i.e. radiators personalized in every little detail, from dimensions to shape and colour; with exclusive patterns, engraving and finishing. The luxury radiator by Hotech is not only aesthetics, but also quality of materials, technology and ecology; objects designed to guarantee utmost comfort while also fully protecting the environment and people.

Зал, несомненно представляет собой пульсирующее сердце дома, в которой мы проводим больше всего времени с семьёй и гостями, где можно почитать книгу, послушать музыку, посмотреть телевизор, пообедать или просто отдохнуть. Поэтому очевидно, что при оформлении гостиной необходимо уделить внимание каждой мельчайшей детали - для создания идеального места для семейной жизни и принятия гостей.

Дизайнерские радиаторы Hotech созданы специально для вас: тех, кому не подходят обычные батареи, кто ищет уникальное изделие, модели и решения, воплощающие в себе самые актуальные тенденции современного стиля жизни на любой вкус - от минимализма до классического барокко.

Тот, кто выбирает Hotechdesignradiators, получает продукт fullcustom, то есть полностью персонализируемое в каждой своей детали изделие - начиная от размеров, формы и цвета и заканчивая рисунками, гравировкой и эксклюзивной отделкой. Люксовый радиатор марки Hotech - это не только эстетика, но и качество материалов, технологии и экология. Радиаторы спроектированы для гарантии максимального комфорта с соблюдением экологичности.

# PRINCESS

design by Federico Guastaroba

98

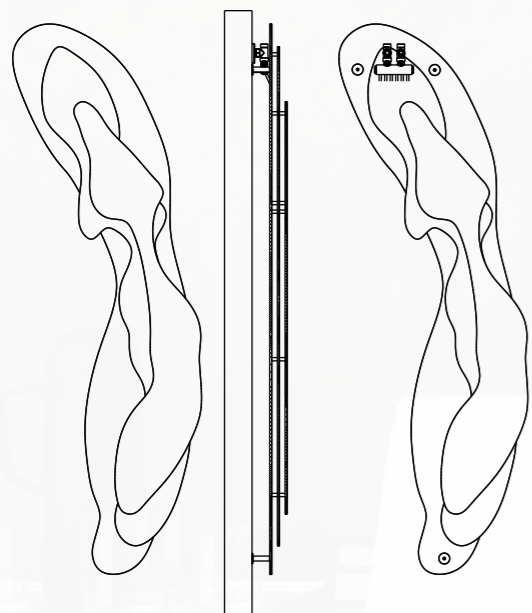

**ELECTRIC VERSION**  
available



**HYDRAULIC VERSION**  
available



**FINISHING**  
pag. 38 - 45



**ACCESSORIES**  
pag. 144 - 147

Le schede tecniche complete sono disponibili sul sito  
[www.hotechdesign.com](http://www.hotechdesign.com)

The complete technical data sheets are available at  
[www.hotechdesign.com](http://www.hotechdesign.com)

Les fiches techniques complètes sont disponibles sur  
[www.hotechdesign.com](http://www.hotechdesign.com)

Полные технические данные доступны на сайте  
[www.hotechdesign.com](http://www.hotechdesign.com)

99





100

# KLIMT

design by Hotech



101



**ELECTRIC VERSION**  
available



**HYDRAULIC VERSION**  
available



**ACCESSORIES**  
pag. 144 - 147



**HYBRID POWER**  
available



**FINISHING**  
pag. 38 - 45



**INTERAXIS**  
center to center variable  
distance

Le schede tecniche complete sono disponibili sul sito  
[www.hotechdesign.com](http://www.hotechdesign.com)

The complete technical data sheets are available at  
[www.hotechdesign.com](http://www.hotechdesign.com)

Les fiches techniques complètes sont disponibles sur  
[www.hotechdesign.com](http://www.hotechdesign.com)

Полные технические данные доступны на сайте  
[www.hotechdesign.com](http://www.hotechdesign.com)

# WILDE

design by  
Diego Paderno, Arianna Filippini, Federica Ravera

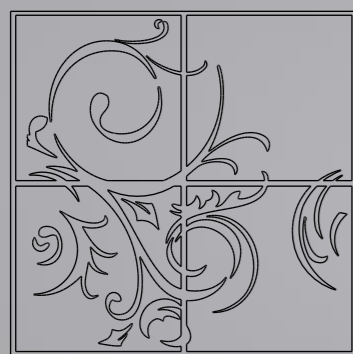

102

103



**ELECTRIC VERSION**  
available



**HYDRAULIC VERSION**  
available



**ACCESSORIES**  
pag. 144 - 147



**HYBRID POWER**  
available



**FINISHING**  
pag. 38 - 45



**DOUBLE COLOR**  
available



**INTERAXIS**  
center to center variable  
distance

Le schede tecniche complete sono disponibili sul sito  
[www.hotechdesign.com](http://www.hotechdesign.com)

The complete technical data sheets are available at  
[www.hotechdesign.com](http://www.hotechdesign.com)

Les fiches techniques complètes sont disponibles sur  
[www.hotechdesign.com](http://www.hotechdesign.com)

Полные технические данные доступны на сайте  
[www.hotechdesign.com](http://www.hotechdesign.com)





# QUADRO

design by Hotech

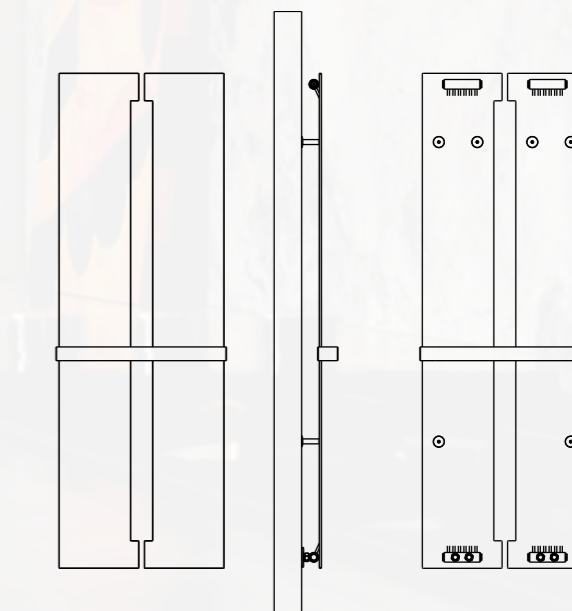

**ELECTRIC VERSION**  
available



**ACCESSORIES**  
pag. 144 - 147



**SPECIAL FINISHING**  
available



**HYDRAULIC VERSION**  
available



**DOUBLE COLOR**  
available



**FINISHING**  
pag. 38 - 45

Le schede tecniche complete sono disponibili sul sito  
[www.hotechdesign.com](http://www.hotechdesign.com)

The complete technical data sheets are available at  
[www.hotechdesign.com](http://www.hotechdesign.com)

Les fiches techniques complètes sont disponibles sur  
[www.hotechdesign.com](http://www.hotechdesign.com)

Полные технические данные доступны на сайте  
[www.hotechdesign.com](http://www.hotechdesign.com)

# GECO

design by Hotech



106

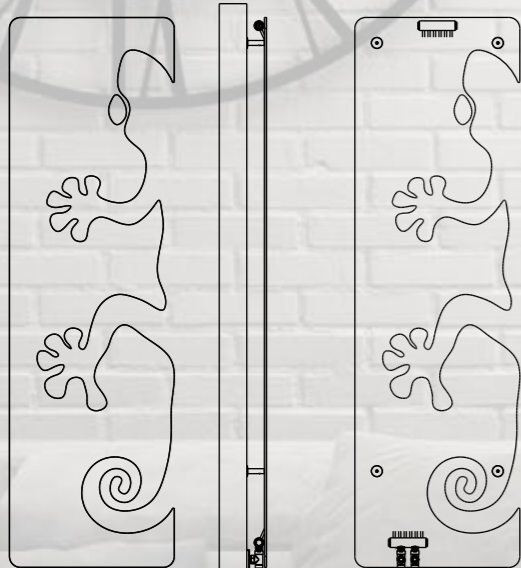

**ELECTRIC VERSION**  
available



**HYDRAULIC VERSION**  
available



**ACCESSORIES**  
pag. 144 - 147



**DOUBLE COLOR**  
available



**FINISHING**  
pag. 38 - 45

Le schede tecniche complete sono disponibili sul sito [www.hotechdesign.com](http://www.hotechdesign.com)

The complete technical data sheets are available at [www.hotechdesign.com](http://www.hotechdesign.com)

Les fiches techniques complètes sont disponibles sur [www.hotechdesign.com](http://www.hotechdesign.com)

Полные технические данные доступны на сайте [www.hotechdesign.com](http://www.hotechdesign.com)



107





# GECO DOUBLE

design by Hotech





 **ELECTRIC VERSION**  
power watt  
1970

 **ACCESSORIES**  
pag. 144 - 147

 **FINISHING**  
pag. 38 - 45

 **SPECIAL FINISHING**  
available

 **HYDRAULIC VERSION**  
power watt  $\Delta T$  at 50°  
1970

 **DOUBLE COLOR**  
available

 **INTERAXIS**  
center to center variable  
distance

Le schede tecniche complete sono disponibili sul sito  
[www.hotechdesign.com](http://www.hotechdesign.com)

The complete technical data sheets are available at  
[www.hotechdesign.com](http://www.hotechdesign.com)

Les fiches techniques complètes sont disponibles sur  
[www.hotechdesign.com](http://www.hotechdesign.com)

Полные технические данные доступны на сайте  
[www.hotechdesign.com](http://www.hotechdesign.com)

**U**no dei segreti del successo di Hotech, risiede nella lavorazione tecnologica avanzata, applicata per la realizzazione dei radiatori. I termoarredi sono ottenuti con una tecnica brevettata che implica la lavorazione tridimensionale del metallo, utilizzando tecnologie complesse e competenze tecniche di alto livello.

L'utilizzo esclusivo di metalli nobili, non ferrosi ed altamente conduttivi, come l'alluminio ed il rame, accoppiati in modo ottimale, come solo Hotech è in grado di offrire; garantiscono elevate prestazioni, rapidità di esercizio e alte rese, a fronte di un consistente risparmio energetico. Ricorrendo a questo sistema produttivo, l'intero apparato tecnologico è sintetizzato nello spessore di soli 8 millimetri; trovarsi di fronte ad un potente radiatore, sottile quanto uno smartphone, ci ricorda che anche l'impossibile a volte può diventare realtà. Hotech con i suoi prodotti, ha segnato un passaggio evolutivo nella storia della produzione di caloriferi, per il riscaldamento di ambienti domestici e pubblici.

Il corpo dei radiatori è ottenuto dalla lavorazione dal pieno dell'alluminio con sofisticati macchinari a controllo numerico; ogni oggetto può quindi vantare caratteristiche di durabilità, robustezza e continuità d'efficienza, che vanno oltre ogni standard esistente sul mercato.

L'un des secrets du succès de Hotech, réside dans le traitement technologique avancé, appliqué à la réalisation des radiateurs. Les radiateurs décoratifs sont obtenus avec une technique brevetée qui implique le traitement tridimensionnel du métal, en utilisant des technologies complexes et des compétences techniques de haut niveau.

L'utilisation exclusive de métaux nobles, non ferreux et très conducteurs, tels l'aluminium et le cuivre, couplés de façon optimale, comme seulement Hotech peut offrir. Ils garantissent des prestations élevées, la rapidité d'exercice et des hauts rendements, en échange d'une importante économie d'énergie. En utilisant ce système productif, tout l'appareil technologique est synthétisé dans une épaisseur de seulement 8 millimètres; se trouver devant un radiateur puissant, aussi mince qu'un smartphone, nous rappelle que même l'impossible peut parfois devenir réalité.

Le corps des radiateurs est obtenu en travaillant de l'aluminium en bloc avec des machines à commande numérique sophistiquées; chaque objet peut ainsi revendiquer des caractéristiques de durabilité, de robustesse et de continuité d'efficacité, qui vont au-delà de tout standard existant sur le marché.

One of the secrets of Hotech's success lies in the advanced technological manufacturing applied for making radiators. Radiators are obtained with a patented technique involving the three-dimensional processing of metal, by using complex technologies and high-level technical skills.

The exclusive use of noble, non-ferrous, highly conductive metals, such as aluminium and copper, coupled in a perfect manner – the way only Hotech can offer – guarantees high performance, quick operation and high efficiency, as well as constant energy saving. By resorting to this production system, the thickness of the entire technological equipment could be reduced to only 8 millimetres; standing in front of a powerful radiator – as thin as a smartphone – reminds us that even the impossible can sometimes be achieved. With its products, Hotech have marked an evolutionary passage in the history of the production of radiators, for heating rooms in domestic and public areas.

The body of radiators is obtained by machining billet aluminium with sophisticated numerical control machines; each object is therefore characterised by durability, robustness and continuous efficiency, going beyond the standards existing in the market.

Один из секретов успеха Hotech состоит в применении в процессе производства самых передовых технологий. Радиаторы создаются по запатентованной технологии, использующей трёхмерную обработку металла с применением сложных техник и навыков высокого уровня.

Использование исключительно благородных, нежелезистых металлов с высокой проводимостью, таких как алюминий и медь, в неповторимом стиле Hotech гарантирует высокие показатели работы, скорость нагрева и высокую продуктивность в сочетании со значительной экономией энергии.

При использовании этой производственной системы вся техническая часть заключена в конструкцию толщиной всего лишь восемь миллиметров. Мощный радиатор, тонкий как смартфон? Иногда даже невозможное становится возможным.

Корпус радиаторов производится из монолитного алюминия, обрабатываемого при помощи сложных станков с числовым программным управлением; каждое изделие отличается долговечностью, прочностью и стабильностью, намного превышающими стандарты рынка.



# ECLIPSE

design by Maria Giardini, Federica Sandrini

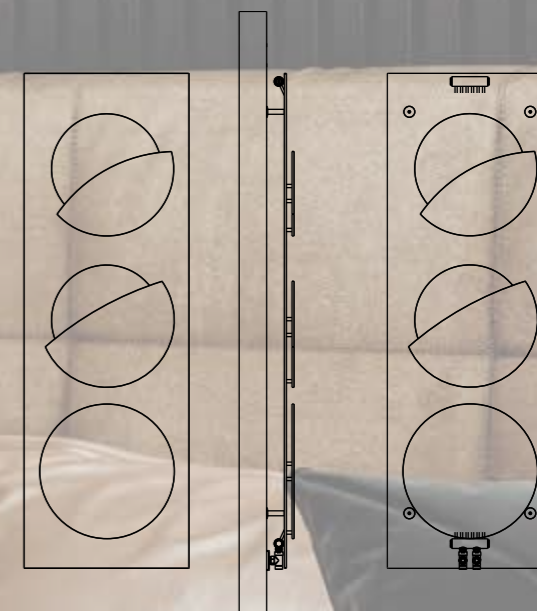

**ELECTRIC VERSION**  
available



**ACCESSORIES**  
pag. 144 - 147



**FINISHING**  
pag. 38 - 45



**HYDRAULIC VERSION**  
available



**DOUBLE COLOR**  
available



**INTERAXIS**  
center to center variable  
distance

Le schede tecniche complete sono disponibili sul sito  
[www.hotechdesign.com](http://www.hotechdesign.com)

The complete technical data sheets are available at  
[www.hotechdesign.com](http://www.hotechdesign.com)

Les fiches techniques complètes sont disponibles sur  
[www.hotechdesign.com](http://www.hotechdesign.com)

Полные технические данные доступны на сайте  
[www.hotechdesign.com](http://www.hotechdesign.com)

# BREUER

design by Hotech

114

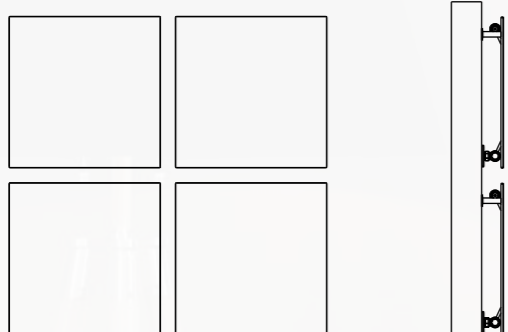

**ELECTRIC VERSION**  
available



**HYDRAULIC VERSION**  
available



**ACCESSORIES**  
pag. 144 - 147



**DOUBLE COLOR**  
available



**FINISHING**  
pag. 38 - 45



**SPECIAL FINISHING**  
available

Le schede tecniche complete sono disponibili sul sito  
[www.hotechdesign.com](http://www.hotechdesign.com)

The complete technical data sheets are available at  
[www.hotechdesign.com](http://www.hotechdesign.com)

Les fiches techniques complètes sont disponibles sur  
[www.hotechdesign.com](http://www.hotechdesign.com)

Полные технические данные доступны на сайте  
[www.hotechdesign.com](http://www.hotechdesign.com)

115







# BERNINI

design by Hotech



 **ELECTRIC VERSION**  
available

 **HYDRAULIC VERSION**  
available

 **FINISHING**  
pag. 38 - 45

 **ACCESSORIES**  
pag. 144 - 147

Le schede tecniche complete sono disponibili sul sito  
[www.hotechdesign.com](http://www.hotechdesign.com)

The complete technical data sheets are available at  
[www.hotechdesign.com](http://www.hotechdesign.com)

Les fiches techniques complètes sont disponibles sur  
[www.hotechdesign.com](http://www.hotechdesign.com)

Полные технические данные доступны на сайте  
[www.hotechdesign.com](http://www.hotechdesign.com)

# MODULE

design by Hotech



118

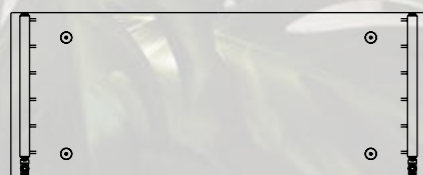

119



**ELECTRIC VERSION**  
available



**HYDRAULIC VERSION**  
available



**ACCESSORIES**  
pag. 144 - 147



**INTERAXIS**  
center to center variable  
distance



**FINISHING**  
pag. 38 - 45



**SPECIAL FINISHING**  
available



**HYBRID POWER**  
available

Le schede tecniche complete sono disponibili sul sito  
[www.hotechdesign.com](http://www.hotechdesign.com)

The complete technical data sheets are available at  
[www.hotechdesign.com](http://www.hotechdesign.com)

Les fiches techniques complètes sont disponibles sur  
[www.hotechdesign.com](http://www.hotechdesign.com)

Полные технические данные доступны на сайте  
[www.hotechdesign.com](http://www.hotechdesign.com)

# MODULE DOUBLE

design by Hotech

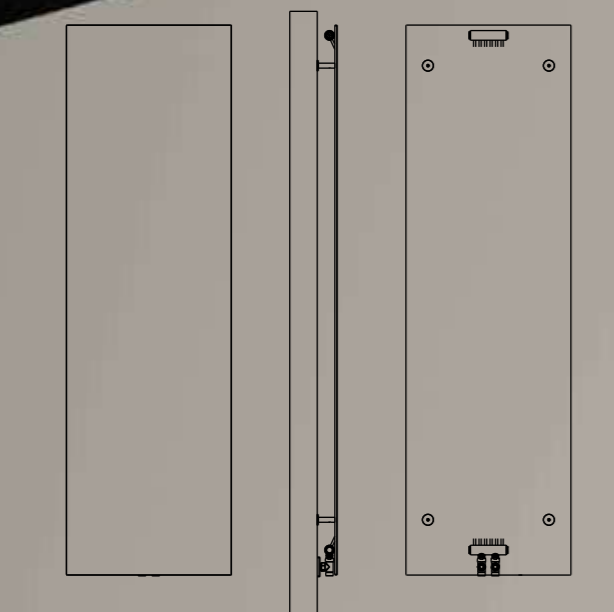

120

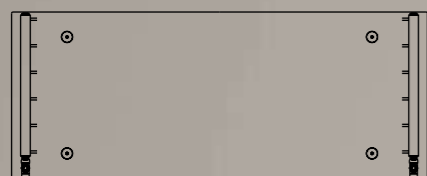
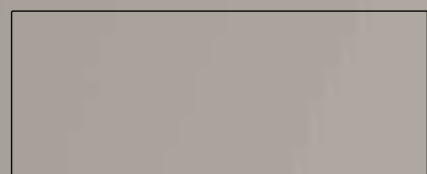

**ELECTRIC VERSION**  
available



**HYDRAULIC VERSION**  
available



**ACCESSORIES**  
pag. 144 - 147



**HYBRID POWER**  
available



**FINISHING**  
pag. 38 - 45



**SPECIAL FINISHING**  
available



**INTERAXIS**  
center to center variable  
distance

Le schede tecniche complete sono disponibili sul sito  
[www.hotechdesign.com](http://www.hotechdesign.com)

The complete technical data sheets are available at  
[www.hotechdesign.com](http://www.hotechdesign.com)

Les fiches techniques complètes sont disponibles sur  
[www.hotechdesign.com](http://www.hotechdesign.com)

Полные технические данные доступны на сайте  
[www.hotechdesign.com](http://www.hotechdesign.com)

121





# GRACE

design by Monica Pilenghi

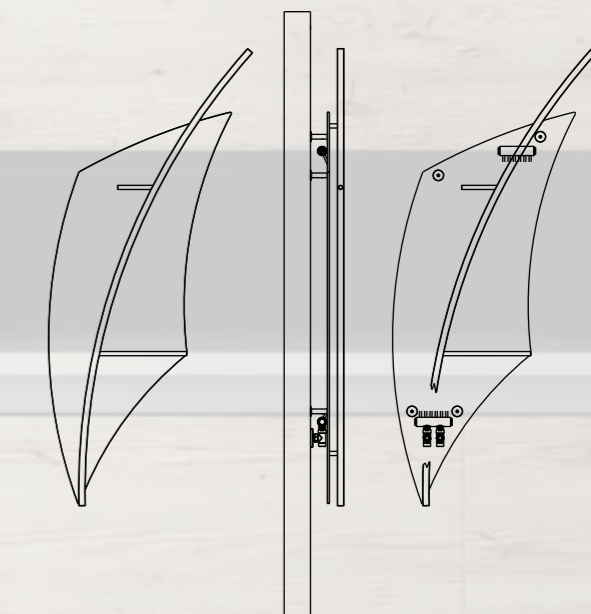

**SIZES**  
1500 x 500 mm



**ELECTRIC VERSION**  
power watt  
525



**ACCESSORIES**  
pag. 144 - 147



**HYDRAULIC VERSION**  
power watt  $\Delta T$  at 50°  
525



**FINISHING**  
38 - 45



**SPECIAL FINISHING**  
available

Le schede tecniche complete sono disponibili sul sito  
[www.hotechdesign.com](http://www.hotechdesign.com)

The complete technical data sheets are available at  
[www.hotechdesign.com](http://www.hotechdesign.com)

Les fiches techniques complètes sont disponibles sur  
[www.hotechdesign.com](http://www.hotechdesign.com)

Полные технические данные доступны на сайте  
[www.hotechdesign.com](http://www.hotechdesign.com)



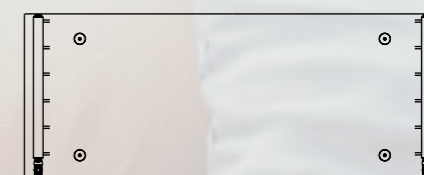
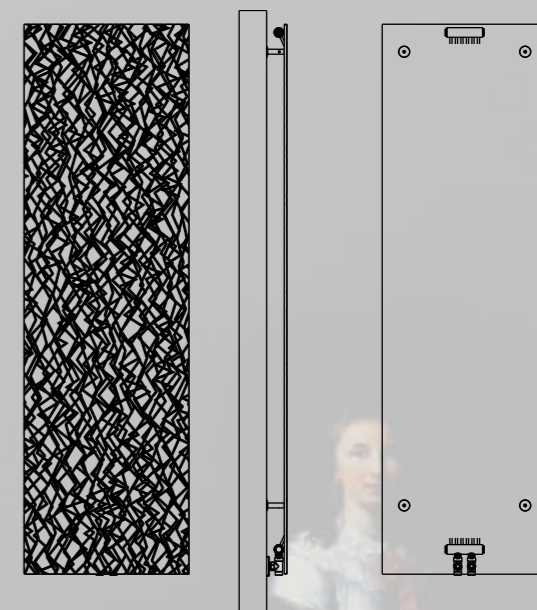

# BOCCIONI

design by Hotech





 **ELECTRIC VERSION**  
available

 **ACCESSORIES**  
pag. 38 - 45

 **FINISHING**  
pag. 144 - 147

 **HYBRID POWER**  
available

 **HYDRAULIC VERSION**  
available

 **INTERAXIS**  
center to center variable  
distance

 **SPECIAL FINISHING**  
boccioni surface

Le schede tecniche complete sono disponibili sul sito  
[www.hotechdesign.com](http://www.hotechdesign.com)

The complete technical data sheets are available at  
[www.hotechdesign.com](http://www.hotechdesign.com)

Les fiches techniques complètes sont disponibles sur  
[www.hotechdesign.com](http://www.hotechdesign.com)

Полные технические данные доступны на сайте  
[www.hotechdesign.com](http://www.hotechdesign.com)

**È** ormai risaputo che uno degli ingredienti per creare prodotti di successo, è senza dubbio il Design.

Da sempre Hotech investe molto in questa direzione, circondandosi dei migliori designer a livello internazionale; esperti del settore il cui compito è quello di ideare soluzioni di alto valore estetico, per proporre una gamma di prodotti, sempre aggiornata, in linea con le più attuali tendenze stilistiche e architettoniche.

La creatività e lo stile sono da sempre punti d'eccellenza del Made in Italy, per questo motivo, nei prodotti Hotech, troverete sempre, tecnologie innovative e forme accattivanti, in grado di creare un legame intimo ed emozionale con il cliente.

Coniugare tempestivamente lo sviluppo tecnologico, che porta a nuove funzionalità; con la forma estetica più corretta, significa proporsi al momento giusto sul mercato con prodotti di alto design e indubbio valore. Oggetti destinati a fornire risposte alle esigenze individuate, apportando un concreto avanzamento tecnologico nel settore, attraverso la chiave vincente del "bello e funzionale".

126

Tout le monde sait que l'un des ingrédients pour créer des produits de succès est sans aucun doute le Design.

Depuis toujours, Hotech investit beaucoup dans cette direction, s'entourant des meilleurs designers au niveau international ; des experts dans le domaine dont la tâche est de concevoir des solutions de haute valeur esthétique, pour proposer une gamme de produits, toujours mis à jour, en ligne avec les dernières tendances dans le style et l'architecture. La créativité et le style sont depuis toujours des points d'excellence du Made in Italy, c'est pourquoi dans les produits Hotech, vous trouverez toujours, des technologies innovantes et des formes attrayantes, capables de créer une relation intime et émotionnelle avec le client.

Combiner rapidement le développement technologique, qui conduit à de nouvelles fonctionnalités, avec la forme esthétique la plus correcte, cela signifie se proposer au bon moment sur le marché avec des produits de haute conception et de valeur indubitable. Des objets conçus pour apporter des réponses aux besoins identifiés, apportant une avancée technologique concrète dans le secteur; à travers la clé gagnante du « beau et fonctionnel ».

It is a well-known fact that design is undoubtedly one of the 'ingredients' to create a successful product.

Hotech have always invested a lot in design, resorting to the best international designers who are experts in the sector; they are to devise solutions with a high aesthetic value to offer a of range of products that is constantly updated and in line with the latest trends in style and in architecture. Creativity and style have always been the strong points of the Made-in-Italy heritage. So, innovative technologies and appealing shapes are always present in Hotech products that create a close and emotional bond with customers.

To duly blend technical advances that result in new functions and the perfect appearance means to come out to the market at the right time offering top design and items of unquestionable value. Items that clearly respond to the needs identified and provide a true technology breakthrough in the industry by epitomizing the winning concept of 'beautiful and practical'.

Хорошо известно, что одним из основных ингредиентов для создания успешного продукта является Дизайн.

Hotech всегда уделяла большое внимание этому направлению, сотрудничая с лучшими дизайнерами мирового уровня - экспертами в своей области, способными создавать высокоэстетичные решения, - для того, чтобы предложить клиентам наиболее современную гамму продуктов, соответствующую самым актуальным стилистическим и архитектурным тенденциям. Креативность и стиль всегда являлись ключевыми характеристиками Made in Italy. Поэтому в изделиях Hotech вы найдёте инновационные технологии и пленяющие формы, способные войти в тесный эмоциональный контакт с клиентом.

Удачное сочетание технологического прогресса, несущего новые функциональные возможности, и наиболее актуальной эстетической формы позволяет в нужный момент предложить рынку изделия высокого дизайна и несомненной ценности. Это продукты, отвечающие индивидуальным требованиям и несущие конкретный технологический прогресс в своей области посредством выигрышной комбинации красоты и функциональности.

127

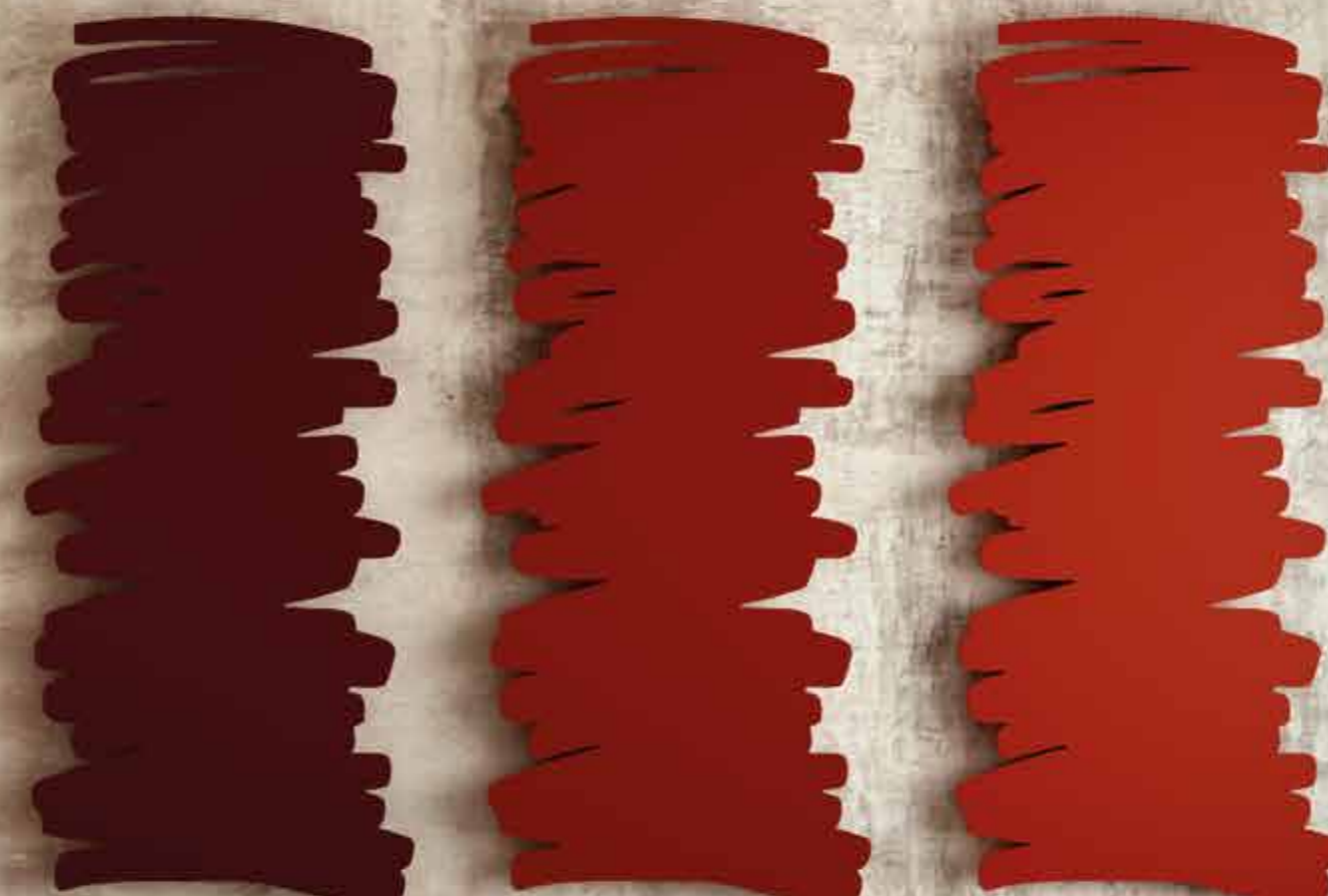

SHAPING THE FUTURE



# PARALLAX

design by Giovanni Tomasini



**ELECTRIC VERSION**  
available



**ACCESSORIES**  
pag. 144 - 147



**FINISHING**  
pag. 38 - 45



**HYDRAULIC VERSION**  
available



**INTERAXIS**  
center to center variable  
distance

Le schede tecniche complete sono disponibili sul sito  
[www.hotechdesign.com](http://www.hotechdesign.com)

The complete technical data sheets are available at  
[www.hotechdesign.com](http://www.hotechdesign.com)

Les fiches techniques complètes sont disponibles sur  
[www.hotechdesign.com](http://www.hotechdesign.com)

Полные технические данные доступны на сайте  
[www.hotechdesign.com](http://www.hotechdesign.com)



# MAGRITTE

design by Hotech

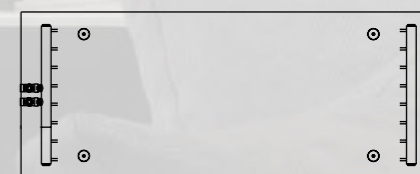
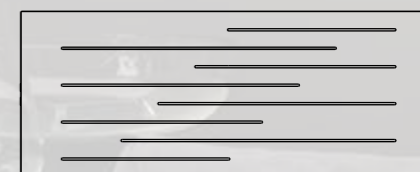
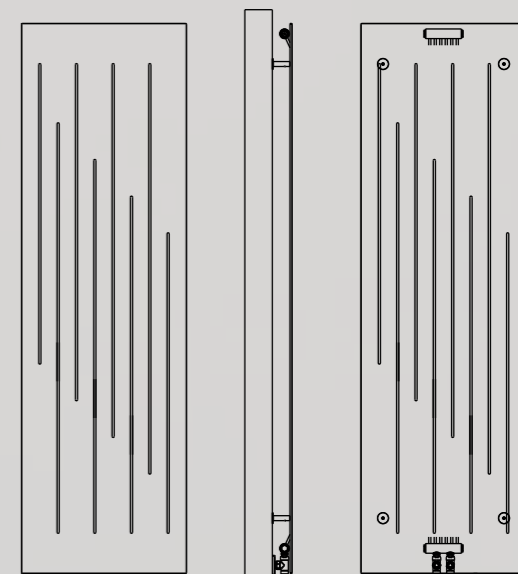

HYDRAULIC VERSION  
available



ACCESSORIES  
pag. 144 - 147



FINISHING  
pag. 38 - 45

Le schede tecniche complete sono disponibili sul sito  
[www.hotechdesign.com](http://www.hotechdesign.com)

The complete technical data sheets are available at  
[www.hotechdesign.com](http://www.hotechdesign.com)

Les fiches techniques complètes sont disponibles sur  
[www.hotechdesign.com](http://www.hotechdesign.com)

Полные технические данные доступны на сайте  
[www.hotechdesign.com](http://www.hotechdesign.com)



**T**utti i radiatori che Hotech produce sono disponibili sia in versione idraulica che elettrica; entrambi caratterizzati da una tecnologia esclusiva e finemente ottimizzata, che rende unici ed inimitabili questi termoarredi.

Il sistema di irradiazione del calore è una soluzione brevettata Hotech; prevede l'accoppiamento a stretto contatto, di un circuito composto da tubi in rame, ed una lastra scanalata in alluminio massiccio, seguendo un tracciato studiato via software per calcolarne la portata ed implementarne le rese.

L'unione di rame e alluminio, garantisce una perfetta ed istantanea trasmissione del calore, aumentando le potenzialità d'esercizio del termoarredo. Il rame presenta inoltre molteplici vantaggi: è antibatterico, previene quindi la formazione di micro alghe che pregiudicherebbero l'efficienza del circuito riscaldante; ed ha un'eccellente resistenza a corrosione, superiore a quella dell'acciaio e del ferro zincato, non teme quindi le acque molto acide.

I collettori dove confluiscono le tubazioni in rame sono in acciaio inossidabile, lavorati a mano; le valvole utilizzate, sono prodotti Made in Italy, disponibili con diverse finiture galvaniche.

134

Tous les radiateurs produits par Hotech sont disponibles tant en version hydraulique qu'électrique : toutes les deux caractérisées par une technologie exclusive et finement optimisée qui rend ces radiateurs décoratifs uniques et inimitables.

Le système d'irradiation thermique est une solution brevetée Hotech ; elle prévoit le couplement en contact étroit, d'un circuit composé de tubes en cuivre, et d'une feuille cannelée en aluminium massif, suivant une trajectoire conçue par logiciel pour en calculer le débit et en implémenter les rendements. L'union du cuivre et de l'aluminium garantit une transmission parfaite et instantanée de la chaleur, augmentant le potentiel de performance du radiateur décoratif. Le cuivre présente également de multiples avantages : il est antibactérien, empêchant ainsi la formation de micro algues qui compromettraient l'efficacité du circuit de chauffage, et a une excellente résistance à la corrosion, supérieure à celle de l'acier et du fer galvanisé, donc il ne craint pas les eaux très acides. Les collecteurs où confluaient les tuyaux de cuivre sont en acier inox AISI 304, usinés à la main ; les valves utilisées sont des produits Made in Italy, disponibles avec différentes finitions galvaniques.

All radiators made by Hotech come in two energy options- heating (hydraulic) only and an electric only. Both feature exclusive and fine-tuned technology that has been optimized so that these designer radiators are unique and unequalled.

The heat radiation system is a solution patented by Hotech: a circuit of copper pipes fully integrated into a grooved plate made of sturdy aluminium following a layout specially designed via software to calculate capacity and implement outputs.

The combination of copper and aluminium guarantees that heat is perfectly and instantly transferred, which enhances the operation potential of the radiator. Copper offers a lot of advantages as well. It has antibacterial properties- and so it prevents the formation of micro-algae that would compromise the efficiency of the heating circuit-; it also shows excellent corrosion resistance, higher than that of steel and zinc-coated iron, and stands very acid waters.

The handcrafted manifolds where the copper pipes converge are made of ASIA 304 stainless steel. The valves used are 100% Made-in-Italy products that come in different galvanic finishes.

Все радиаторы Hotech доступны как в водяной, так и в электрической версии. Они характеризуются использованием эксклюзивной и чётко оптимизированной технологии, которая делает их уникальными и неповторимыми.

Система распространения тепла, запатентованная Hotech, предусматривает тесное взаимодействие контура из медных труби панели из монолитного алюминия в соответствии со схемой, протестированной компьютерным путём для вычисления производительности и увеличения продуктивности.

Комбинация меди и алюминия гарантирует идеальное и мгновенное распространение тепла, увеличивая рабочий потенциал радиатора. Кроме того, медь обладает рядом дополнительных преимуществ: она имеет антибактериальные свойства, то есть предотвращает формирование микроводорослей, способных нарушить работу нагревательного контура; она крайне устойчива к коррозии, превосходя в этом сталь и оцинкованное железо, поэтому ей не страшны кислые воды.

Коллекторы, к которым подсоединены медные трубы, выполнены вручную из нержавеющей стали AISI 304. Используемые клапаны сделаны в Италии и имеют различное гальваническое покрытие.

# MATERIALS

135



# MEDICEO

design by Federico Guastaroba

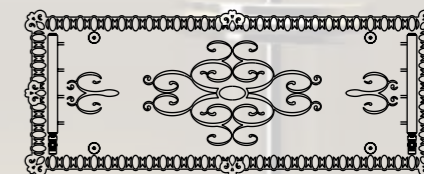
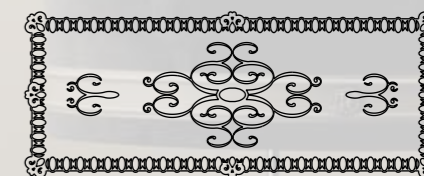
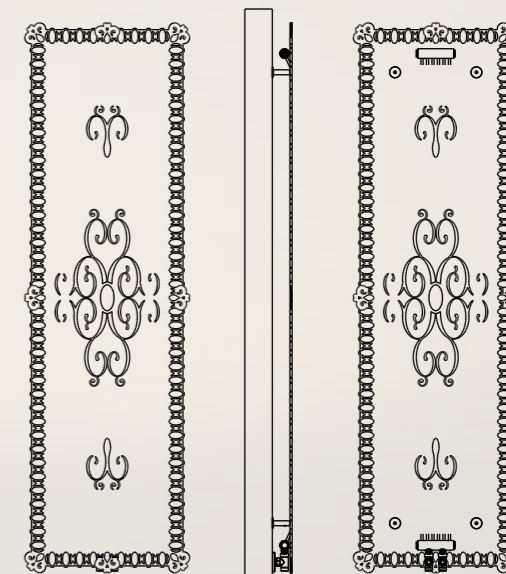

**ELECTRIC VERSION**  
available



**FINISHING**  
pag. 38 - 45



**ACCESSORIES**  
pag. 144 - 147



**HYDRAULIC VERSION**  
available



**INTERAXIS**  
center to center variable  
distance

Le schede tecniche complete sono disponibili sul sito  
[www.hotechdesign.com](http://www.hotechdesign.com)

The complete technical data sheets are available at  
[www.hotechdesign.com](http://www.hotechdesign.com)

Les fiches techniques complètes sont disponibles sur  
[www.hotechdesign.com](http://www.hotechdesign.com)

Полные технические данные доступны на сайте  
[www.hotechdesign.com](http://www.hotechdesign.com)



# HERMITAGE

design by Hotech

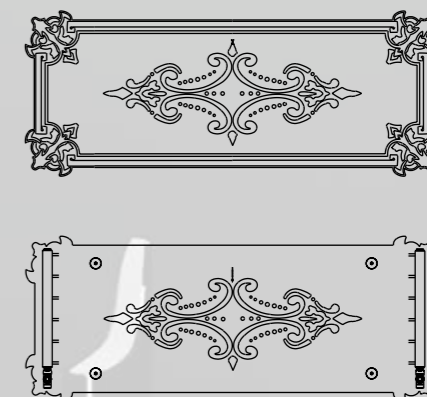
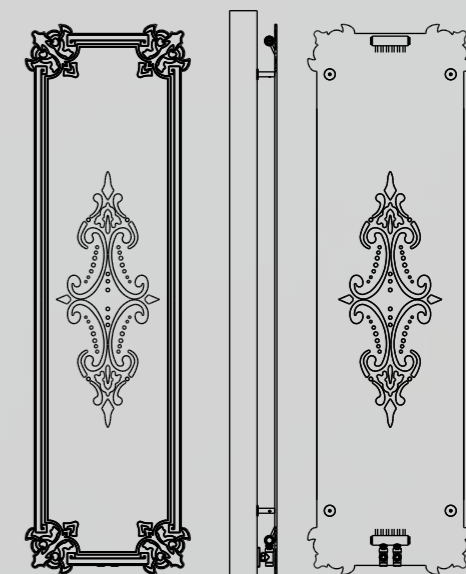

**ELECTRIC VERSION**  
available



**FINISHING**  
pag. 38 - 45



**ACCESSORIES**  
pag. 144 - 147



**HYDRAULIC VERSION**  
available



**INTERAXIS**  
center to center variable  
distance

Le schede tecniche complete sono disponibili sul sito  
[www.hotechdesign.com](http://www.hotechdesign.com)

The complete technical data sheets are available at  
[www.hotechdesign.com](http://www.hotechdesign.com)

Les fiches techniques complètes sont disponibles sur  
[www.hotechdesign.com](http://www.hotechdesign.com)

Полные технические данные доступны на сайте  
[www.hotechdesign.com](http://www.hotechdesign.com)

**O**pra è la nuova linea termoarredi che Hotech ha specificamente studiato per il settore contract, avvalendosi di designer esperti nel settore. Forme semplici e leggere per un radiatore di design che rispecchia le moderne tendenze stilistiche, riducendo gli ingombri ed ottimizzando gli spazi, laddove le metrature sono un rigido vincolo progettuale. L'alternativa funzionale, al tradizionale scaldasalviette; soluzione all'avanguardia in termini di design, prezzo e innovazione. È un "contract personalizzabile", quello che propone Hotech design radiators, con questo prodotto, che fa della flessibilità una formula vincente; su richiesta del cliente, Opra può essere realizzato con dimensioni ed interassi variabili, per adattarsi ad ogni collocazione o andare a rimpiazzare caloriferi esistenti, senza modifiche all'impianto e agli attacchi idraulici. Disponibili sia in versione elettrica che idraulica, i modelli Opra, compatti, potenti e lussuosi, trovano applicazione ottimale come termoarredi per Yacht e imbarcazioni, di alto livello. Non solo uffici, alberghi e negozi, il fascino discreto e raffinato della linea di radiatori Opra, conquista anche il privato che ricerca un calorifero moderno e funzionale.

140

Opra est la nouvelle gamme de radiateurs décoratifs que Hotech a spécialement conçus pour le secteur contractuel, en faisant appel à des designers experts dans le secteur. Des formes simples et légères pour un radiateur design qui reflète les tendances stylistiques modernes, en réduisant les encombrements et en optimisant les espaces, là où les dimensions sont une contrainte de conception rigide.

C'est un «contrat personnalisable», celui qui offre des radiateurs design Hotech, avec ce produit, qui fait de la flexibilité une formule gagnante ; à la demande du client. Opra peut être réalisé avec des dimensions et des entraxes variables, pour s'adapter à n'importe quelle collocation ou pour remplacer les calorifères existants, sans changements au système et aux raccordements hydrauliques.

Disponibles tant en version électrique qu'hydraulique, les modèles Opra, compacts, puissants et luxueux, trouvent une application optimale en tant que radiateurs décoratifs pour yachts et embarcations de haut niveau.

Non seulement bureaux, Hôtels et magasins! Le charme discret et raffiné de la ligne de radiateurs Opra, conquiert aussi le privé qui cherche un calorifère moderne et fonctionnel.

Opra is the new line of radiators that has been specifically researched and developed by Hotech for the contract sector, resorting to expert designers in this sector. Simple and light shapes for a design radiator that reflects modern style trends, reducing dimensions and optimising space, in those cases in which measurements constitute a strict constraint in terms of design.

With this product, Hotech offer a 'customisable contract', which turns flexibility into a winning formula; upon the customer's request, Opra can be made with variable dimensions and distances between centres, so that it can be adapted to any arrangement or replace the existing heaters, without having to modify the installation or the hydraulic connections.

Available in electrical and hydraulic versions, Opra models – which are compact, powerful and sumptuous – can be optimally applied as radiators for high-level yachts and vessels.

Not only offices, hotels and shops; the discreet and refined charm of the Opra line of radiators also conquers private customers who are searching for a modern and functional radiator.

Опра - это новая линия радиаторов, специально созданная Hotech для реализации проектов «под ключ», к работе над которой были привлечены наиболее опытные в этой области дизайнеры. Простые и лёгкие формы дизайнерского радиатора отражают современные тенденции стиля, снижая нагрузку помещения, оптимизируя пространство там, где метраж является ограничивающим фактором. Решение, предлагаемое Hotech, - это персонализированный проект «под ключ», главным преимуществом которого является гибкость. По запросу клиента «Опра» может быть выполнена с изменяемыми размерами и расстоянием между креплениями, что позволит ей адаптироваться к любому размещению и заменить существующие радиаторы без необходимости изменения водопроводной сети и стыков.

Модели линии «Опра» доступны как в водяной, так и в электрической версии: компактные, мощные, роскошные, они могут быть применены на яхтах и судах высокого уровня. Полное достоинства очарование линии «Опра» подходит не только для офисов, отелей и магазинов: она может быть использована и в частных домах, в которых требуются современные и функциональные радиаторы.

## OPRA LINE inox

141

# OPRA

design by Hotech

142

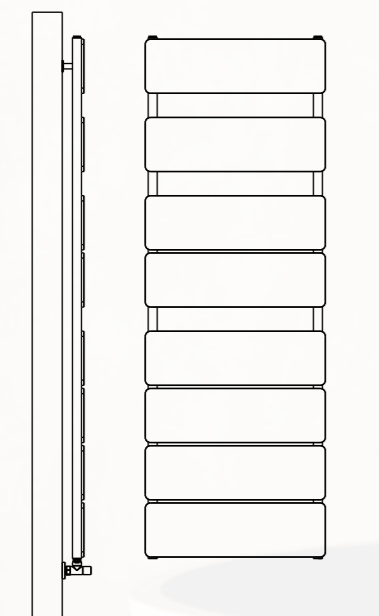

**ELECTRIC VERSION**  
on request



**HYDRAULIC VERSION**  
available



**ACCESSORIES**  
pag. 144 - 147



**INTERAXIS**  
center to center variable  
distance



**FINISHING**  
pag. 38 - 45

Le schede tecniche complete sono disponibili sul sito  
[www.hotechdesign.com](http://www.hotechdesign.com)

The complete technical data sheets are available at  
[www.hotechdesign.com](http://www.hotechdesign.com)

Les fiches techniques complètes sont disponibles sur  
[www.hotechdesign.com](http://www.hotechdesign.com)

Полные технические данные доступны на сайте  
[www.hotechdesign.com](http://www.hotechdesign.com)

143



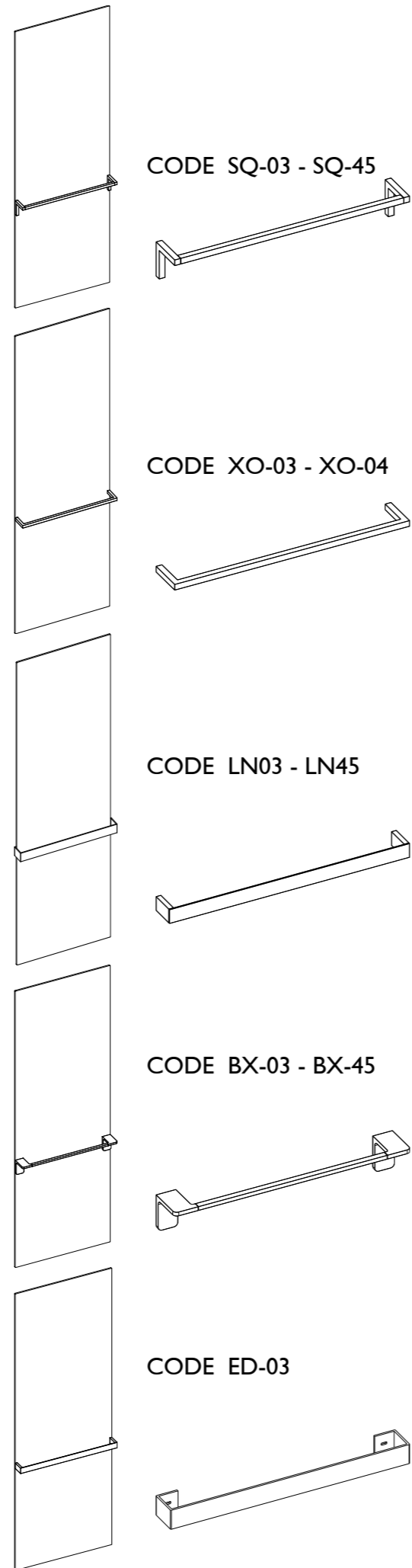

# SQUARE



# XONI



# LAPIANA



# BRIXIA



# EDGE

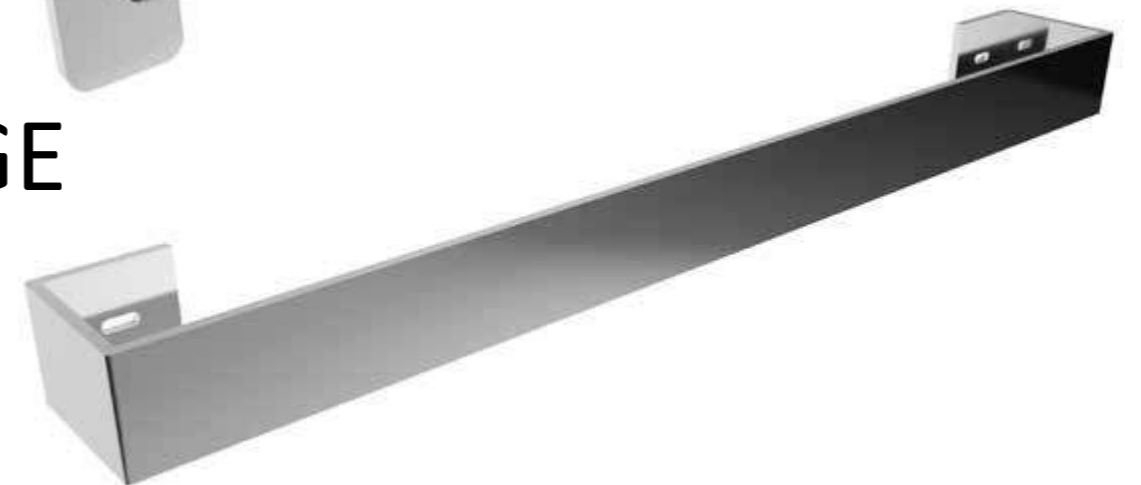

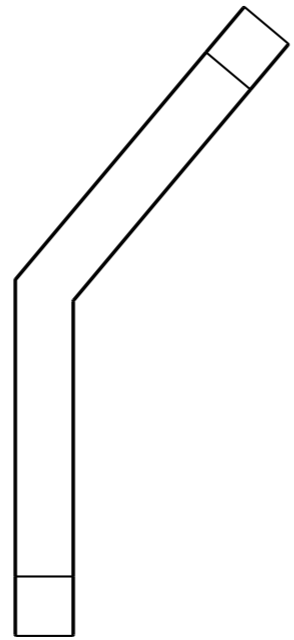

CODE - BX08

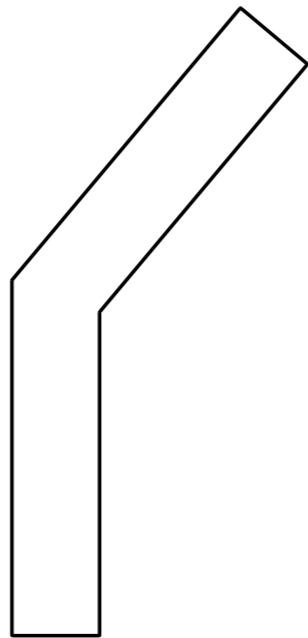

CODE - SQ08 (Square)  
CODE - XO-09 (Xoni)

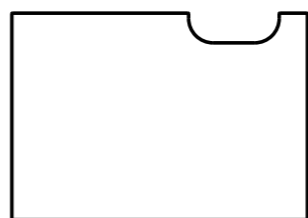

CODE LN03 - LN45

# BRIXIA



# SQUARE XONI



# LAPIANA



**S**cegliere un prodotto Made in Italy rappresenta una scelta etica e consapevole, in quanto le normative che regolano la produzione sul territorio Italiano, garantiscono standards che rispettano la natura intera: la terra, l'atmosfera, i corsi d'acqua, le persone e tutti gli esseri viventi. Hotech design radiators, ha esplicitamente scelto di realizzare prodotti di alta qualità, la cui fattura e selezione dei materiali, ne determina una lunga durata nel tempo, mantenendone la piena funzionalità d'esercizio.

Ulteriore risparmio energetico è dovuto ai brevetti esclusivi dei quali Hotech dispone, che consentono una notevole riduzione, della quantità d'acqua impiegata (fino a 30 volte inferiore) per il funzionamento del radiatore, a fronte di elevate rese in fase d'esercizio; ciò si traduce in un sensibile abbattimento dei consumi.

L'autentico Made in Italy, risponde anche a tutte le altre caratteristiche, imposte dagli elevati standard europei; le materie prime impiegate, così come ogni componente, sono sicuri la persona, non danneggiano la salute ed evitano il rischio di allergie, contaminazioni e cattivo funzionamento.

148

Choisir un produit Made in Italy représente un choix éthique et conscient, car les réglementations qui régissent la production sur le territoire italien garantissent des standards qui respectent toute la nature : la terre, l'atmosphère, les cours d'eau, les gens et tous les êtres vivants. Hotech Design Radiators a explicitement choisi de créer des produits de haute qualité, dont la facture et la sélection des matériaux, détermine une longue vie dans le temps, en maintenant la pleine fonctionnalité de l'exercice.

D'autres économies d'énergie sont dues aux brevets exclusifs dont Hotech dispose, qui permettent une réduction considérable, de de la quantité d'eau utilisée (jusqu'à 30 fois moins) pour le fonctionnement du radiateur; face aux rendements élevés en phase d'exercice ; cela se traduit par une réduction significative de la consommation.

L'autentique Made in Italy, répond également à toutes les autres caractéristiques imposées par les standards européens élevés ; les matières premières utilisées, ainsi que chaque composant, sont sans danger pour la personne, ne nuisent pas à la santé et évitent le risque d'allergies, de contamination et de mauvais fonctionnement.

Choosing a Made in Italy product represents an ethical, informed choice, given the fact that the regulations governing production on the Italian territory guarantee standards that respect nature as a whole: the ground, the atmosphere, watercourses, people and all living beings. Hotech Design Radiators have explicitly decided to produce high-quality products, the manufacture and selected raw materials of which guarantee a long service life over time, maintaining their full operating functionality.

Further energy saving is obtained thanks to the exclusive patents held by Hotech, which enable a significant reduction in the amount of water used (up to 30 times less) for the radiator operation, as well as high efficiency in the operating phase; all this results in a considerable decrease in consumption.

The authentic Made in Italy also meets all the other characteristics set by high European standards; the raw materials used, as well as all components, are safe for people, do not impair health and avoid the risk of allergies, contamination and incorrect operation.

Выбрать изделие Made in Italy - значит сделать осознанный и этический выбор, поскольку производственные нормы на территории Италии подчиняются стандартам, призванным оберегать природу: землю, воздух, водные потоки, людей и всех живых существ. Компания Hotechdesignradiators сделала выбор в пользу производства товаров высокого качества с использованием долговечных материалов и технологий, обеспечивающих полную работоспособность на длительный срок.

Дополнительная экономия энергии достигается благодаря эксклюзивным патентам Hotech, позволяющим достичь значительного снижения расхода воды (до 30 раз) при работе радиатора, сохранив высокую отдачу. Это отражается в значительном снижении затрат.

Истинное Made in Italy отвечает также всем другим требованиям, выдвигаемым повышенными европейскими стандартами: используемое сырьё и все компоненты надёжны для пользователя, не вредят здоровью и не несут риска аллергии, загрязнения или неполноценной работы.



149

**ECOLOGY**

# VALVE KIT

Nel kit valvole sono compresi la placca interasse 50 mm. e i relativi copritubo del colore del gruppo valvole la raccorderia per tubo rame e/o tubo multistrato ( e necessario specificare in sede d'ordine il diametro e lo spessore dei tubi di mandata e di ritorno e il tipo di tubo utilizzato ).

Valve set includes, 50 mm. interaxis plate and covers for pipes of the same colour, pipes for copper or multi-layer pipe (when ordering, you must specify diameter and thickness of inlet and outlet pipes and type of pipes used).

Dans le kit de soupapes il y a inclus la plaque entraxe 50 mm et les couvre-tuyaux dans la couleur du kit de soupapes, les raccords pour tuyau en cuivre et/ou multicouches (a la commande il est necessaire de specifier le diametre et l'epaisseur des tuyaux d'entree et de retour et le type de tuyau utilise).

Комплект включает пластину 50мм, покрытие для труб, соответствующего цвета группы клапанов фитинги для медных труб и/или для многослойных труб (необходимо указать при заказе тип используемых труб диаметр и толщину трубы на вход и на выход).



# REMOTE VALVES

Alcuni modelli della nostra collezione, necessitano di un gruppo valvole remoto, questo sistema risulta efficace quando il radiatore e molto intagliato e non e possibile nascondere le valvole nella parte posteriore del radiatore, questo gruppo valvole puo essere posizionato ovunque nella stanza e permette il comando " a distanza " del radiatore senza che quest'ultimo venga penalizzato nelle sue forme.

Some models of our collection need a remote valve set; this system is necessary when the radiator is very cutted and it is not possible to hide the valves in the rear part of the radiator. This valve set can be located everywhere in the room and allows the remote control of the radiator without damaging its shape.

Quelques modeles de notre collection ont besoin d'un groupe remote de soupapes; ces systeme est efficace quand le radiateur est entaille et il n'est pas possible de cacher les soupapes dans la partie posterieure du radiateur ; ce groupe de soupapes peut etre place n'importe ou dans la piece et permet la commande « a distance » du radiateur sans que ce dernier soit penalise dans les formes.

Некоторые модели нашей коллекции нуждаются в группе клапанов которые устанавливаются на расстоянии от радиатора, такая система является эффективной когда поверхность радиатора с резьбой и невозможно спрятать клапаны в нижней части радиатора. Данная группа клапанов может быть установлена в любом месте помещения и позволяет управлять радиатором " на расстоянии " не нанося ущерба форме и плавным линиям модели.



# THERMOSTAT

termostato wi-fi con schermo LCD



Questo apparecchio consente di controllare via onde radio i radiatori in versione elettrica. Questa tecnologia consente di posizionare il radiatore ovunque si desideri nell'ambiente ed alimentarlo normalmente come qualsiasi altro elettrodomestico, la programmazione settimanale di accensione e spegnimento è gestita interamente dal termostato, l'apparecchio funziona dando le istruzioni al radiatore che a bordo monta un ricevitore a onde radio. ( 868 mHz ) conforme con le direttive europee.

This device allows the control through radio waves the radiator in electric version. This technology permit to place the radiatory everywhere you want and power it normally like the other electrical device, the on/off weekly planning is completely managed by the thermostat, the device works giving instructions to the radiators that mount a radio waves receiver. ( 868 mHz ) according the european standards.

Cet appareil permet de controler par moyen de ondes radio le radiateurs en version electrique. N'importe ou dans la piece et de l'alimenter comme un autre appareil electrique normal, la programmation hebdomadaire d'allumage et extinction est toute geree par le thermostat; l'appareil fonctionne en donnant le instructions au radiateur qui monte un receveur a ondes radio. ( 868 mHz ) conforme aux directives europeennes.

Данное устройство позволяет управлять при помощи радиоволн радиаторами электрических версий «hotech design»; эта технология позволяет разместить радиаторы любом желаемом помещении и обеспечивать их питание. Как правило, как и любой другой электробытовой прибор, понедельное программирование включения/выключения полностью управляется термостатом, устройство работает, давая инструкции радиатору, на котором установлен приемник радиоволн. (868 Mhz) соответствует европейским директивам

**hotech**  
DESIGN RADIATORS

Via Giuseppe di Vittorio, 36  
25030 - Castel Mella - Brescia  
ITALY

tel. +39 030 2583230

fax +39 030 2781090

**[www.hotechdesign.com](http://www.hotechdesign.com)**

[www.hotechdesign.com](http://www.hotechdesign.com)