

2021/22



Rubineria



**KELLER
TAPS**

Catalogo generale
Catalogue



Rubinerterie ed Accessori
Taps and accessories



KELLER
TAPS



21/22

Keller Taps è una rubinetteria situata a Gozzano ad un passo dal Lago d'Orta, dove tradizione e cultura nel settore della rubinetteria non hanno rivali in ambito mondiale.

Keller Taps si afferma e si distingue da sempre per la sua considerevole professionalità acquisita negli anni da parte dei titolari, unita ad una gestione efficiente e puntuale.

Queste caratteristiche assicurano una assoluta qualità nel prodotto e nel servizio.

In poco tempo Keller Taps ha infatti ottenuto una risposta positiva da parte degli operatori del settore, sia in ambito italiano che internazionale, grazie a una vasta gamma di prodotti collaudati singolarmente e corredati da una garanzia di cinque anni.

Sicuramente collaborando con Keller Taps migliorate la qualità della vita con prodotti affidabili e cortesia al vostro servizio.

Thanks to
collaboration with



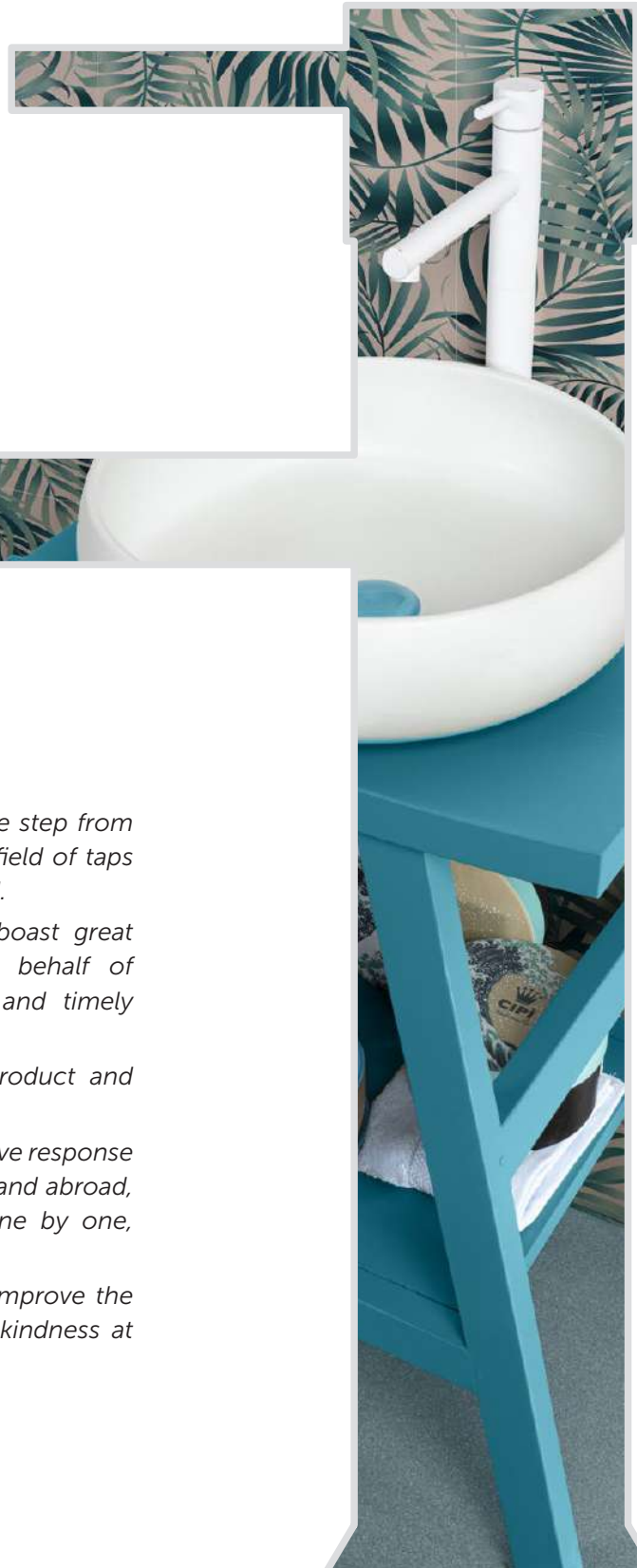

Keller Taps is the fittings firm at Gozzano one step from Lake d'Orta, where tradition and culture in the field of taps and fittings do not have rivals in the whole world.

Keller Taps is affirmed structure that can boast great professionalism acquired over the years on behalf of the owners as well as a dynamic, efficient and timely management.

These characteristics ensure an absolute product and service quality.

In a short time Keller Taps has obtained a positive response on behalf of operators in this field, both in Italy and abroad, thanks to a wide range of products tested one by one, supplied with a five-year guarantee.

By working with Keller Taps you will surely improve the quality of your life with reliable products and kindness at your disposal.

PREVIEW





KT
KELLER
TAPS

CIPÌ
the bathroom
Naturalia





KT
KELLER
TAPPS

CIPÌ
the bathroom
Naturalia

PREVIEWV





PREVIEW

KT
KELLER
TAPS

CIPÌ
the bathroom
Naturalia

INDICE

Index

BAGNO

Bath

		Nature	15
---	---	--------------	----

	Mimi	23
---	------------	----

	Inox	31
---	------------	----

	Minimal	39
---	---------------	----

	Relax	49
---	-------------	----

	Style	55
---	-------------	----

	Saturno	59
---	---------------	----

		Square	69
---	--	--------------	----

	Square	75
--	--------------	----

		Sky	81
---	--	-----------	----

		Winter	85
---	---	--------------	----

	Winter	91
--	--------------	----

	Paris 2	95
--	---------------	----

	Spring	99
--	--------------	----

	Summer	103
--	--------------	-----



KT



Anya 107



Tornado 111



Start 115



King 119



Kiss 123



Sirio 129

NEW



Atlantic 135

NEW



Pacific 141

CUCINA 147
Kitchen

TERMOSTATICI 163
Thermostat control

COLONNE DOCCIA 167
Shower columns

SOFFIONI e BRACCI 187
Shower heads and shower arms

SALISCENDI 203
Sliding bars

RUBINETTI ELETTRONICI 207
Electronic taps

ACCESSORI 211
Spare parts

VK DESIGN 225
Vk Design



FINITURE

Finishings

CR...
Cromo
Chrome
Verchromt



BR...
Bronzo
Bronze
Bronze



...RA
Rame
Copper
Kupfer



...NI
Nichel
Nickel
Nickel



OR...
Oro
Gold
Gold



BO...
Bianco opaco
Matt white
Matt weiß

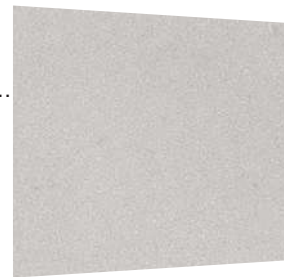

...NO
Nero opaco
Matt black
Mattschwarz

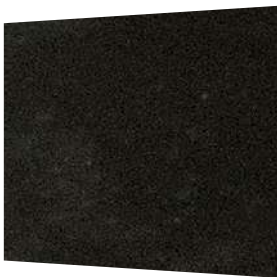

...GLD
Oro spazzolato
Brushed gold
Gold gebürstet



CPR...
Rame spazzolato
Brushed copper
Kupfer gebürstet



GNM...
Canna di fucile
Gun metal
Kanonenmetall



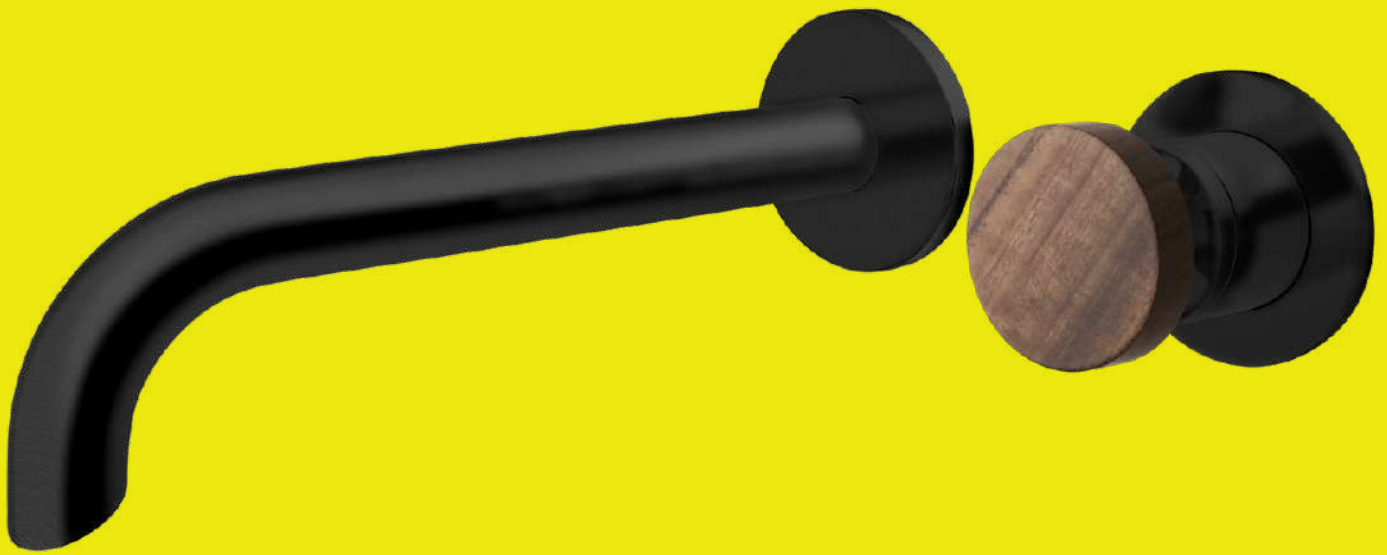

NATURE



Design by Vicky Karantoni



MANIGLIA CON CARTUCCIA PROGRESSIVA

semplicemente ruotando la maniglia
si passa da acqua fredda,
ad acqua miscelata fino ad acqua calda.

HANDLE WITH PROGRESSIVE CARTRIDGE

simply turning the handle you switch from cold water,
mixed water up to hot water.

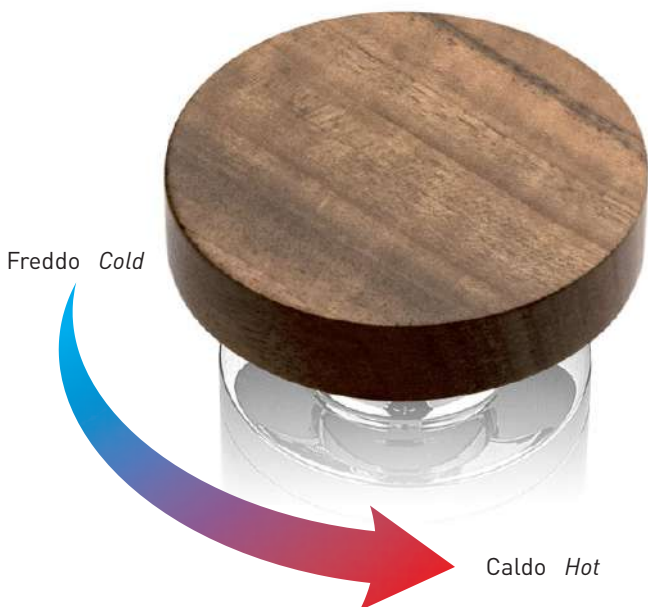

NT 10

Monocomando vasca
 Single lever bath mixer without/with shower kit
 Einhebelmischbatterie für Wanne ohne/mit kit Handbrause



NT 10 SD - senza kit doccia

- _____ CR
- _____ BO - NO
- _____ NI
- _____ BR - RA
- _____ GLD - CPR - GNM
- _____ OR

NT 10 DXC - con kit doccia

- _____ CR
- _____ BO - NO
- _____ NI
- _____ BR - RA
- _____ GLD - CPR - GNM
- _____ OR

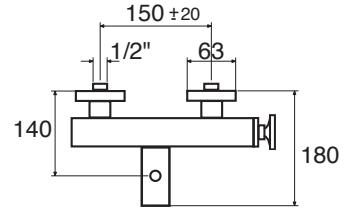

NT 20

Monocomando lavabo con scarico click-clack
 Single lever basin mixer with click-clack waste
 Einhebelmischbatterie für Waschbecken mit Ablaufventil click-clack

NT 20

- _____ CR
- _____ BO - NO
- _____ NI - BR - RA
- _____ GLD - CPR - GNM
- _____ OR

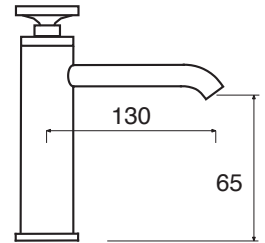

NT 21

Monocomando lavabo alto con scarico click-clack
 Single lever high basin mixer with click-clack waste
 Hohe Einhebelmischbatterie für Waschbecken mit Ablaufventil click-clack

NT 21

- _____ CR
- _____ BO - NO
- _____ NI - BR - RA
- _____ GLD - CPR - GNM
- _____ OR

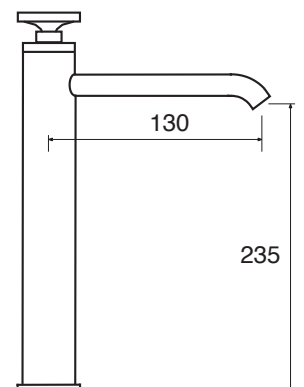



NT 23

Monocomando lavabo con scarico click-clack
Single lever basin mixer with click-clack waste
Einhebelmischbatterie für Waschbecken mit
Ablaufventil click-clack

NT 23

- _____ CR
- _____ BO - NO
- _____ NI - BR - RA
- _____ GLD - CPR - GNM
- _____ OR

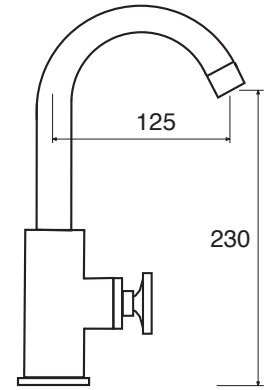

NT 24

Monocomando lavabo con scarico click-clack
Single lever basin mixer with click-clack waste
Einhebelmischbatterie für Waschbecken mit
Ablaufventil click-clack

NT 24

- _____ CR
- _____ BO - NO
- _____ NI - BR - RA
- _____ GLD - CPR - GNM
- _____ OR

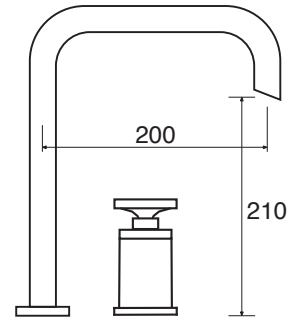

NT 27

Monocomando lavabo incasso orizzontale senza scarico
Concealed single lever basin mixer (horizontal)
Einhebelmischbatterie für Waschbecken zum
horizontalen Einbau ohne Ablauf



NT 27

- _____ CR
- _____ BO - NO
- _____ NI - BR - RA
- _____ GLD - CPR - GNM
- _____ OR

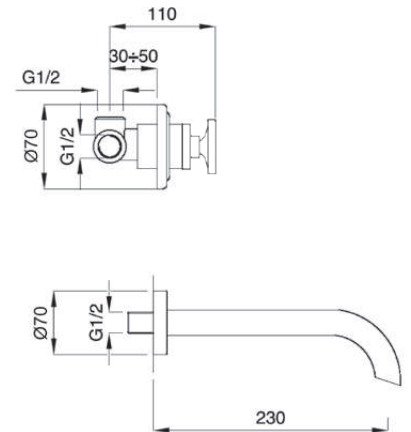

NT 30

Monocomando bidet con scarico click-clack
 Single lever bidet mixer with click-clack waste
 Einhebelmischbatterie für Bidet mit Ablaufventil
 click-clack

NT 30

CR
 BO - NO
 NI - BR - RA
 GLD - CPR - GNM
 OR

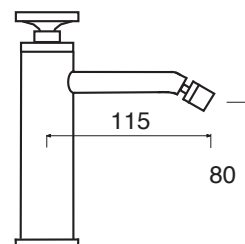
**NT 33**

Monocomando bidet con scarico click-clack
 Single lever bidet mixer with click-clack waste
 Einhebelmischbatterie für Bidet mit Ablaufventil
 click-clack

NT 33

CR
 BO - NO
 NI - BR - RA
 GLD - CPR - GNM
 OR

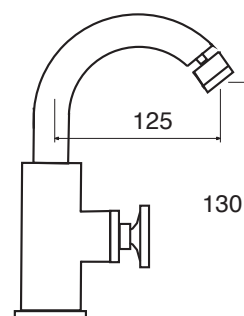
**NT 40**

Monocomando incasso doccia
 Single lever built-in shower mixer
 Einhebelmischbatterie für Dusche zum Einbau

NT 40

CR
 BO - NO
 NI - BR - RA
 GLD - CPR - GNM
 OR

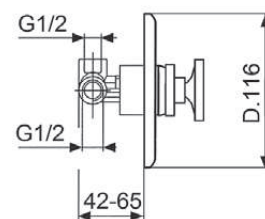
**NT 41**

Monocomando incasso doccia con deviatore a 2 uscite
 Single lever for built-in shower with diverter with 2 outputs
 Einhebelmischbatterie für Dusche zum Einbau mit
 Umschaltventil

NT 41

CR
 BO - NO
 NI - BR - RA
 GLD - CPR - GNM
 OR

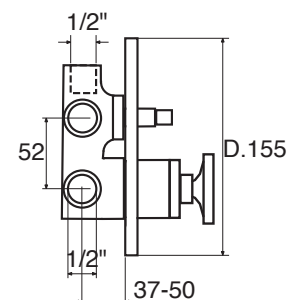



CR



NO



BO



NI



BR



RA



GLD



CPR



GNM



OR

NEW**NT 41/3**

Monocomando incasso doccia con deviatore a 3 uscite
Single lever for built-in shower with diverter with 3 outputs
Einhebelmischbatterie für Dusche zum Einbau mit Umschaltventil

NT 41/3

CR

BO - NO

NI - BR - RA

GLD - CPR - GNM

OR

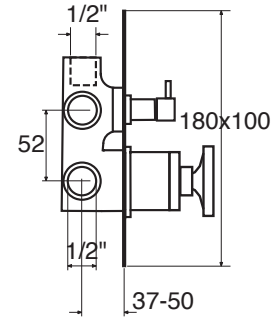

ø 35 mm

**NT 48**

Monocomando incasso doccia con deviatore a 2 uscite, presa acqua con doccetta.
Single lever for built-in shower with diverter with 2 output, water supply with shower.
Einhebelmischbatterie für Dusche zum Einbau mit Umschaltventil.

NT 48

CR

BO - NO

NI - BR - RA

GLD - CPR - GNM

OR

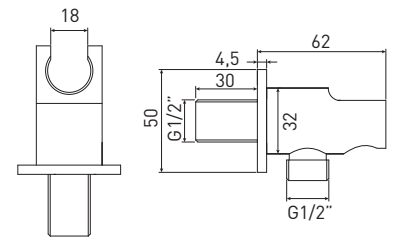
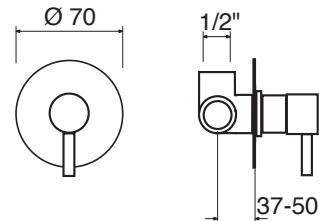
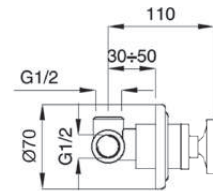

ø 35 mm

NEW**NT 50**

Monocomando esterno doccia
Single lever exterior shower without/with shower kit
Einhebelmischbatterie für Dusche ohne/mit kit Handbrause



ø 35 mm

NT 50 SD - senza kit doccia

CR

BO - NO

NI - BR - RA

GLD - CPR - GNM

OR

NT 50 DC - con kit doccia

CR

BO - NO

NI - BR - RA

GLD - CPR - GNM

OR

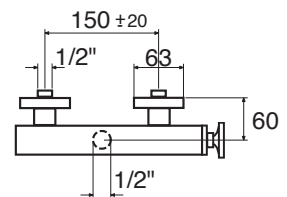

NT 14009/25

Kit soffione cilindrico diametro mm 250 con MISCELATORE incasso doccia, deviatore a 2 uscite + kit doccia cilindrico con presa acqua, flessibile cm 150 e doccetta cilindrica.

Shower kit with headshower and mixer + water supply with flexible hose and handshower.

NT 14009/25 - KIT COMPLETO

CR
BO - NO
NI
BR - RA
GLD - CPR - GNM
OR

NT 16025

Soffione doccia tondo con braccio da 350 mm.
Shower head, in round shape with shower arm 350 mm.
Riesenbrausekopf mit brausenarm 350 mm.

NT 16025 Ø mm.

CR 250
BO - NO 250
NI 250
BR - RA 250
GLD - CPR - GNM 250
OR 250

NT 41

Monocomando incasso doccia con deviatore a 2 uscite.

Single lever for built-in shower with diverter with 2 outputs.

Einhebelmischbatterie für Dusche zum Einbau mit Umschaltventil.

NT 41

CR
BO - NO
NI - BR - RA
GLD - CPR - GNM
OR

NT 99

Presa acqua cilindrica in ottone con supporto. Completa di flessibile satilux e doccetta in ABS.

Round water supply with support.

With luxury flexible and shower.

NT 99

CR
BO - NO
NI
BR - RA
GLD - CPR - GNM
OR





Foto by Gigi SOLDANO, fotografo di sport e di anime sportive.
E' uno dei fotografi più noti nel panorama della MotoGP e delle due ruote a motore.

MIMI'



Design by Vicky Karantoni

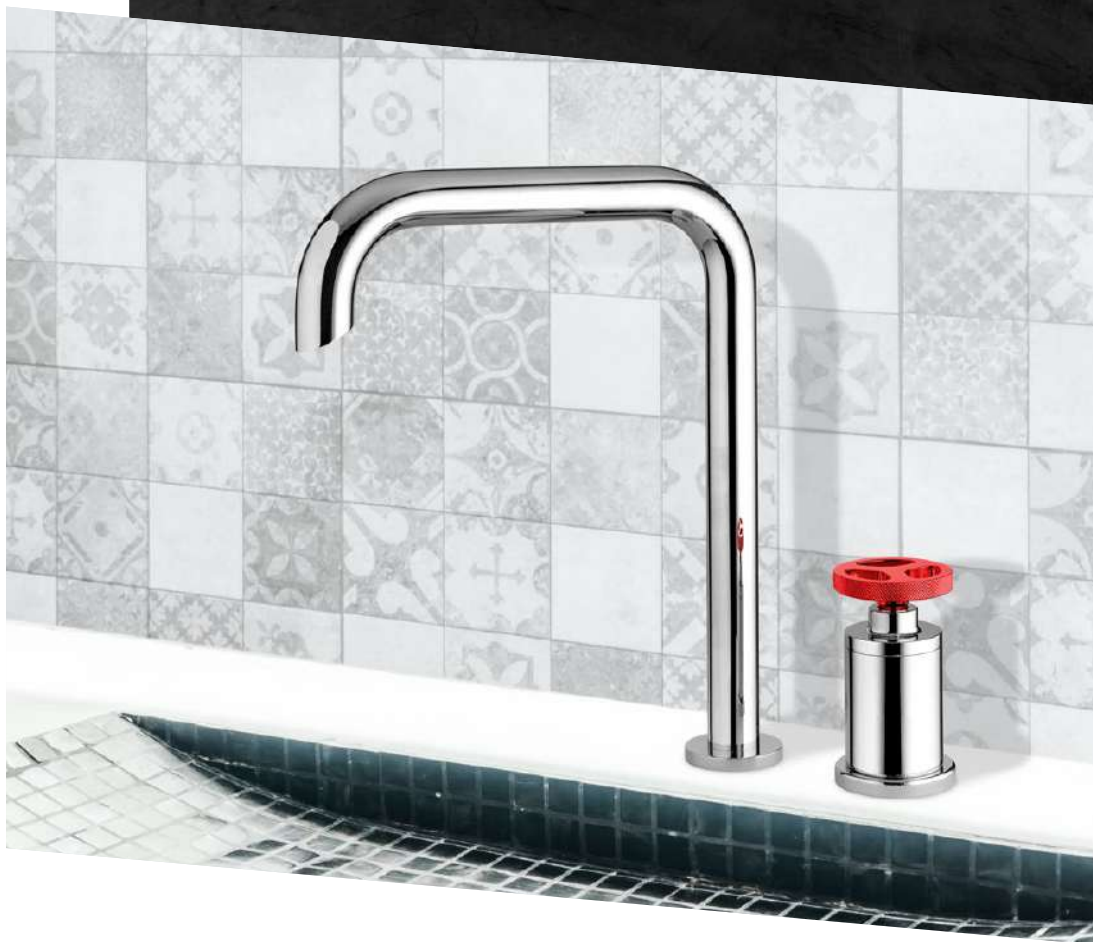

FINITURA MANIGLIA

Handle finishings



Per tutti gli articoli della serie Mimi è disponibile la maniglia nelle seguenti finiture, in abbinamento al corpo nelle altre finiture, senza supplemento di prezzo.

Esempio: Corpo GLD + maniglia RED (foto a sx/sopra) / Corpo CR + maniglia GNM (foto a sx/sotto)



CR



RED



NO



BO



NI



GLD



CPR



GNM

MANIGLIA CON CARTUCCIA PROGRESSIVA

semplicemente ruotando la maniglia si passa da acqua fredda, ad acqua miscelata fino ad acqua calda.

HANDLE WITH PROGRESSIVE CARTRIDGE

simply turning the handle you switch from cold water, mixed water up to hot water.

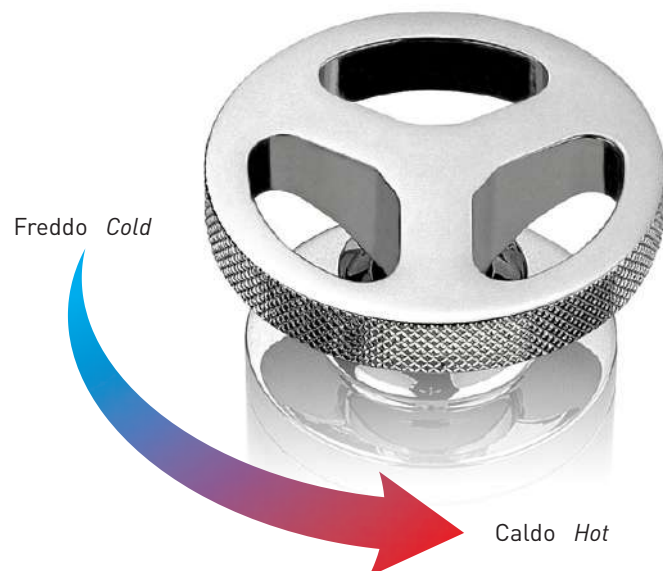



MI 10

Monocomando vasca
 Single lever bath mixer without/with shower kit
 Einhebelmischbatterie für Wanne ohne/mit kit Handbrause



MI 10 SD - senza kit doccia

- _____ CR
- _____ BO - NO
- _____ NI
- _____ BR - RA
- _____ GLD - CPR - GNM
- _____ OR

MI 10 DXC - con kit doccia

- _____ CR
- _____ BO - NO
- _____ NI
- _____ BR - RA
- _____ GLD - CPR - GNM
- _____ OR

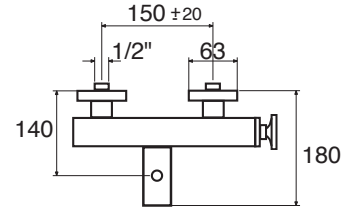

MI 20

Monocomando lavabo con scarico click-clack
 Single lever basin mixer with click-clack waste
 Einhebelmischbatterie für Waschbecken mit Ablaufventil click-clack

MI 20

- _____ CR
- _____ BO - NO
- _____ NI - BR - RA
- _____ GLD - CPR - GNM
- _____ OR

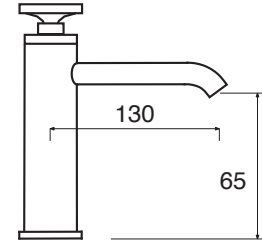

MI 21

Monocomando lavabo alto con scarico click-clack
 Single lever high basin mixer with click-clack waste
 Hohe Einhebelmischbatterie für Waschbecken mit Ablaufventil click-clack

MI 21

- _____ CR
- _____ BO - NO
- _____ NI - BR - RA
- _____ GLD - CPR - GNM
- _____ OR

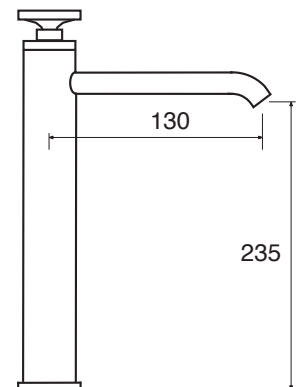

MI 23

Monocomando lavabo con scarico click-clack
Single lever basin mixer with click-clack waste
Einhebelmischbatterie für Waschbecken mit
Ablaufventil click-clack

MI 23

CR
 BO - NO
 NI - BR - RA
 GLD - CPR - GNM
 OR

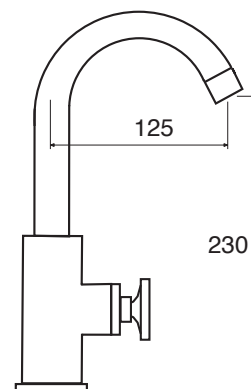

MI 24

Monocomando lavabo con scarico click-clack
Single lever basin mixer with click-clack waste
Einhebelmischbatterie für Waschbecken mit
Ablaufventil click-clack

MI 24

CR
 BO - NO
 NI - BR - RA
 GLD - CPR - GNM
 OR

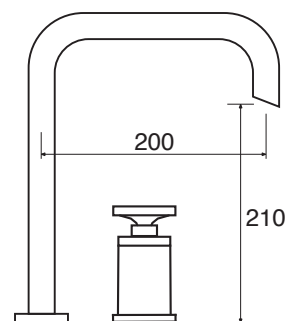

MI 27

Monocomando lavabo incasso orizzontale senza scarico
Concealed single lever basin mixer (horizontal)
Einhebelmischbatterie für Waschbecken zum
horizontalen Einbau ohne Ablauf

MI 27

CR
 BO - NO
 NI - BR - RA
 GLD - CPR - GNM
 OR



NEW

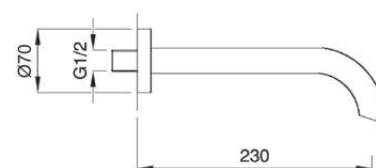
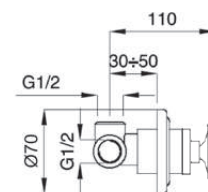



MI 30

Monocomando bidet con scarico click-clack
Single lever bidet mixer with click-clack waste
Einhebelmischbatterie für Bidet mit Ablaufventil click-clack

MI 30

- _____ CR
- _____ BO - NO
- _____ NI - BR - RA
- _____ GLD - CPR - GNM
- _____ OR

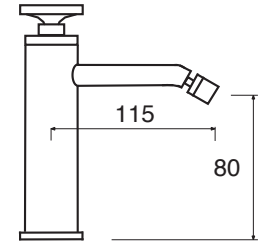

MI 33

Monocomando bidet con scarico click-clack
Single lever bidet mixer with click-clack waste
Einhebelmischbatterie für Bidet mit Ablaufventil click-clack

MI 33

- _____ CR
- _____ BO - NO
- _____ NI - BR - RA
- _____ GLD - CPR - GNM
- _____ OR

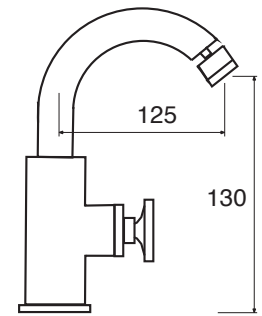

MI 40

Monocomando incasso doccia
Single lever built-in shower mixer
Einhebelmischbatterie für Dusche zum Einbau

MI 40

- _____ CR
- _____ BO - NO
- _____ NI - BR - RA
- _____ GLD - CPR - GNM
- _____ OR

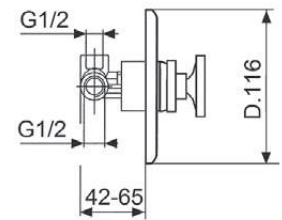

MI 41

Monocomando incasso doccia con deviatore a 2 uscite
Single lever for built-in shower with diverter with 2 outputs
Einhebelmischbatterie für Dusche zum Einbau mit Umschaltventil

MI 41

- _____ CR
- _____ BO - NO
- _____ NI - BR - RA
- _____ GLD - CPR - GNM
- _____ OR

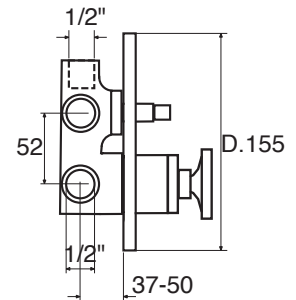

MI 41/3

Monocomando incasso doccia con deviatore a 3 uscite
 Single lever for built-in shower with diverter with 3 outputs
 Einhebelmischbatterie für Dusche zum Einbau mit Umschaltventil

MI 41/3

- _____ CR
- _____ BO - NO
- _____ NI - BR - RA
- _____ GLD - CPR - GNM
- _____ OR

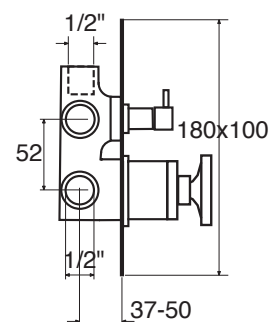

MI 48

Monocomando incasso doccia con deviatore a 2 uscite, presa acqua con doccetta.
 Single lever for built-in shower with diverter with 2 output, water supply with shower.
 Einhebelmischbatterie für Dusche zum Einbau mit Umschaltventil.

MI 48

- _____ CR
- _____ BO - NO
- _____ NI - BR - RA
- _____ GLD - CPR - GNM
- _____ OR



NEW

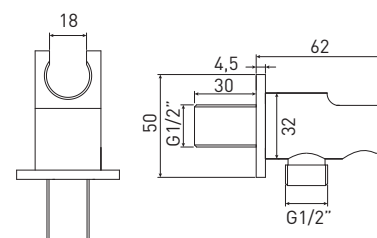
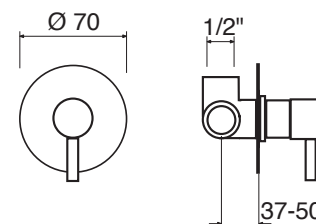
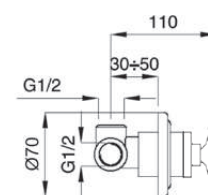

MI 50

Monocomando esterno doccia
 Single lever exterior shower without/with shower kit
 Einhebelmischbatterie für Dusche ohne/mit kit Handbrause



MI 50 SD - senza kit doccia

- _____ CR
- _____ BO - NO
- _____ NI - BR - RA
- _____ GLD - CPR - GNM
- _____ OR

MI 50 DC - con kit doccia

- _____ CR
- _____ BO - NO
- _____ NI - BR - RA
- _____ GLD - CPR - GNM
- _____ OR

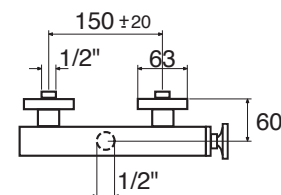



MI 14009/25

Kit soffione cilindrico diametro mm 250 con MISCELATORE incasso doccia, deviatore a 2 uscite + kit doccia cilindrico con presa acqua, flessibile cm 150 e doccetta cilindrica.
Shower kit with headshower and mixer + water supply with flexible hose and handshower.

MI 14009/25 - KIT COMPLETO

CR
BO - NO
NI
BR - RA
GLD - CPR - GNM
OR

MI 16025

Soffione doccia tondo con braccio da 350 mm.
Shower head, in round shape with shower arm 350 mm.
Riesenbrausekopf mit brausenarm 350 mm.

MI 16025	Ø mm.
CR	250
BO - NO	250
NI	250
BR - RA	250
GLD - CPR - GNM	250
OR	250

MI 41

Monocomando incasso doccia con deviatore a 2 uscite.
Single lever for built-in shower with diverter with 2 outputs.
Einhebelmischbatterie für Dusche zum Einbau mit Umschaltventil.

MI 41

CR
BO - NO
NI - BR - RA
GLD - CPR - GNM
OR

MI 99

Presa acqua cilindrica in ottone con supporto. Completa di flessibile satilux e doccetta in ABS.
Round water supply with support.
With luxury flexible and shower.

MI 99

CR
BO - NO
NI
BR - RA
GLD - CPR - GNM
OR



INOX



IX 10

Monocomando vasca

Single lever bath mixer without/with shower kit

Einhebelmischbatterie für Wanne ohne/mit kit

Handbrause

IX 10 SD - senza kit doccia

INOX

IX 10 DC - con kit doccia

INOX



Ø 35 mm

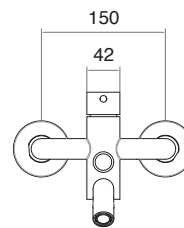

IX 20

Monocomando lavabo con scarico click-clack

Single lever basin mixer with click-clack waste

Einhebelmischbatterie für Waschbecken mit

Ablaufventil click-clack

IX 20

INOX



Ø 35 mm

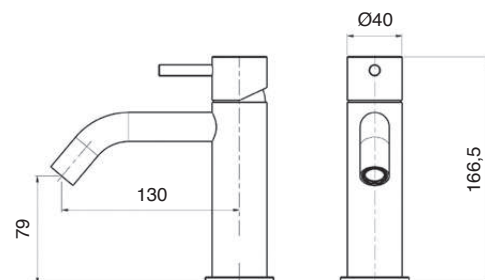

IX 21

Monocomando lavabo alto con scarico click-clack

Single lever high basin mixer with click-clack waste

Hohe Einhebelmischbatterie für Waschbecken mit

Ablaufventil click-clack

IX 21

INOX



Ø 35 mm

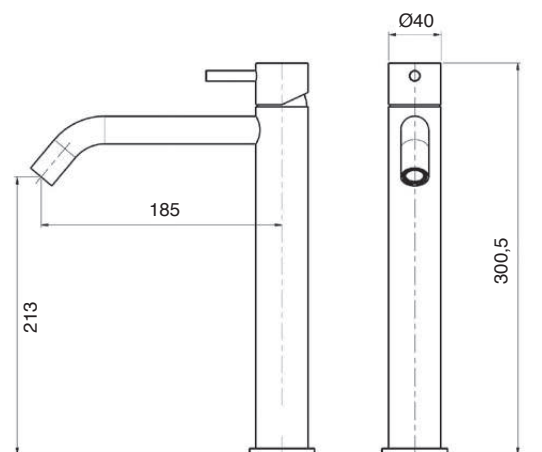

IX 27

Monocomando lavabo incasso orizzontale senza scarico
Concealed single lever basin mixer (horizontal)
Einhebelmischbatterie für Waschbecken zum horizontalen Einbau ohne Ablauf

IX 27

INOX

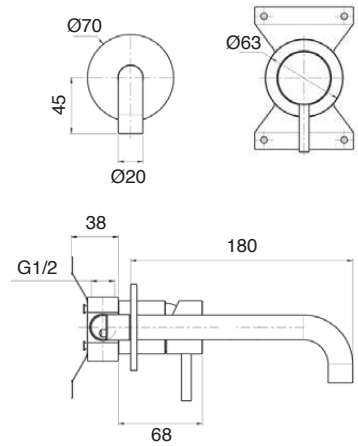

IX 30

Monocomando bidet con scarico click-clack
Single lever bidet mixer with click-clack waste
Einhebelmischbatterie für Bidet mit Ablaufventil click-clack

IX 30

INOX

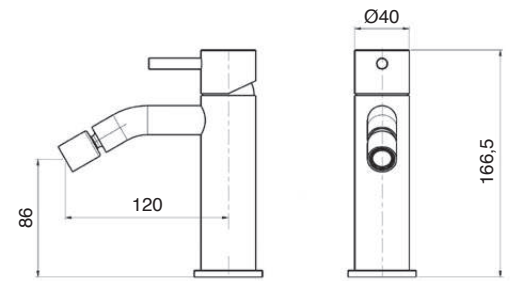

IX 40

Monocomando incasso doccia
Single lever built-in shower mixer
Einhebelmischbatterie für Dusche zum Einbau

IX 40

INOX

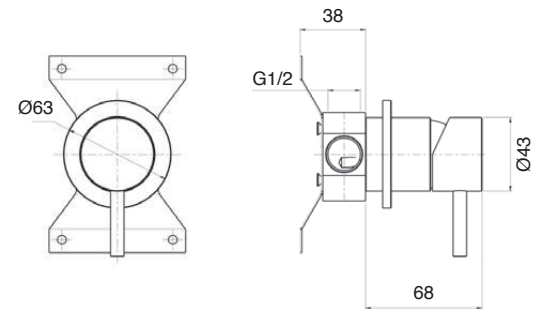

IX 41

Monocomando incasso doccia con deviatore a 2 uscite
Single lever for built-in shower with diverter with 2 outputs
Einhebelmischbatterie für Dusche zum Einbau mit Umschaltventil

IX 41

INOX

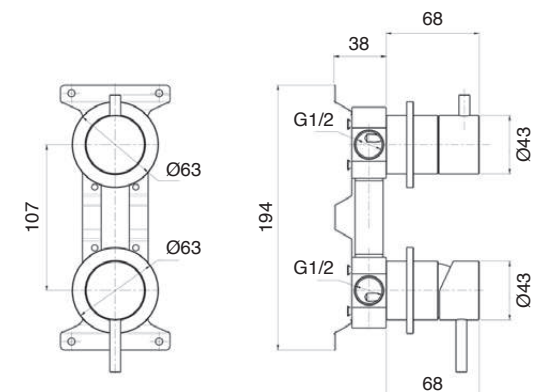

IX 99

Presa acqua cilindrica con supporto.
Round water supply with support.

IX 99

INOX

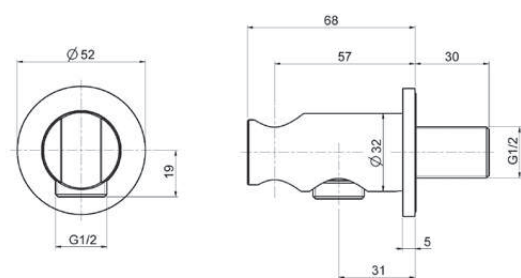

IX 14025

Soffione doccia Ø250 mm con braccio doccia da 400 mm.
Shower head Ø250 mm with shower arm 400 mm.

IX 14025	1 Bar L/min.	2 Bar L/min.	3 Bar L/min.
INOX	11	17	22

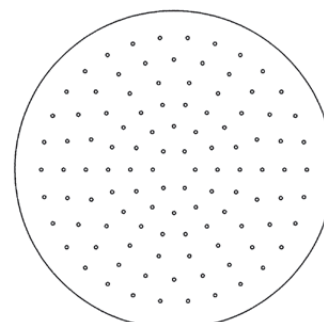

Ø 250

IX 1290

Sifone minimalista 1"1/4.
Minimal syphon 1"1/4.

IX 1290

INOX

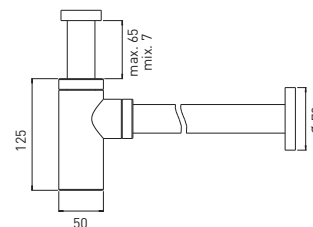

IX 9121

Set idroscopino, flessibile doppia
aggraffatura cm. 150.
*Hydrobrush jet set, flexible hose double
lock cm. 150.*

NEW

Art. _____

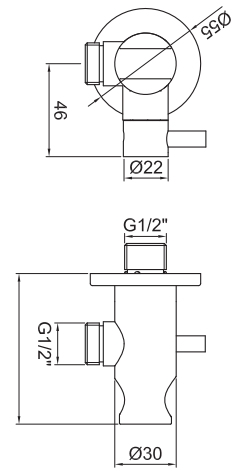
IX 9121**IX 12**

Monocomando vasca a colonna cilindrica
Mixer tub with cylindrical stand
Badewannenmischbatterie mit zylindrischer Säule

NEW**IX 12**

INOX



Ø 35 mm

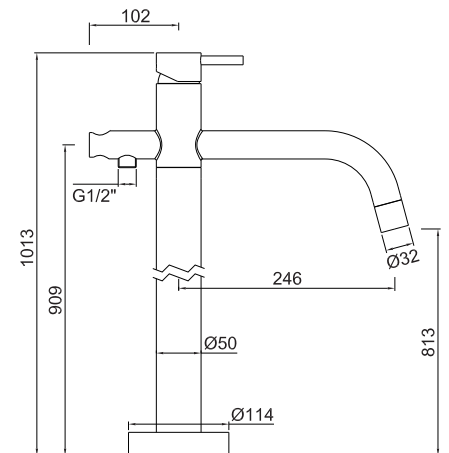

IX 13079/23

Kit colonna doccia cilindrica con deviatore, soffione diametro mm 230, MISCELATORE cilindrico, flessibile cm 150 e doccetta cilindrica. *Shower columns with diverter, headshower Ø 230 mm, mixer, flexible cm 150 and handshower.*

IX 13079/23

INOX

NEW



IX 70 DE

Monocomando cucina canna alta con doccino
 estraibile
One-hole sink mixer, high spout
Küchen-Einhebelmischbatterie mit hohem Auslauf

NEW**IX 70 DE**

INOX

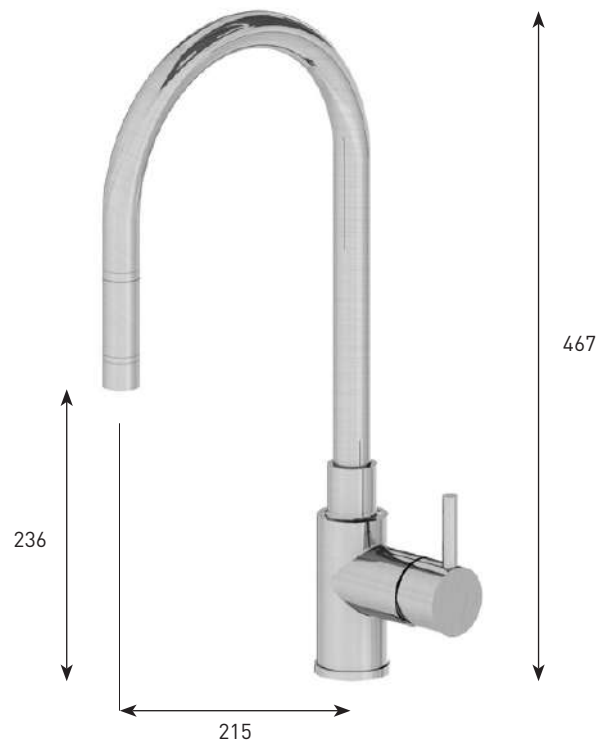

Ø 35 mm

**IX 70 CAO**

Monocomando cucina canna alta
 estraibile
One-hole sink mixer, high spout
Küchen-Einhebelmischbatterie mit hohem Auslauf

NEW**IX 70 CAO**

CR

GLD - CPR - GNM



Ø 35 mm





MINIMAL

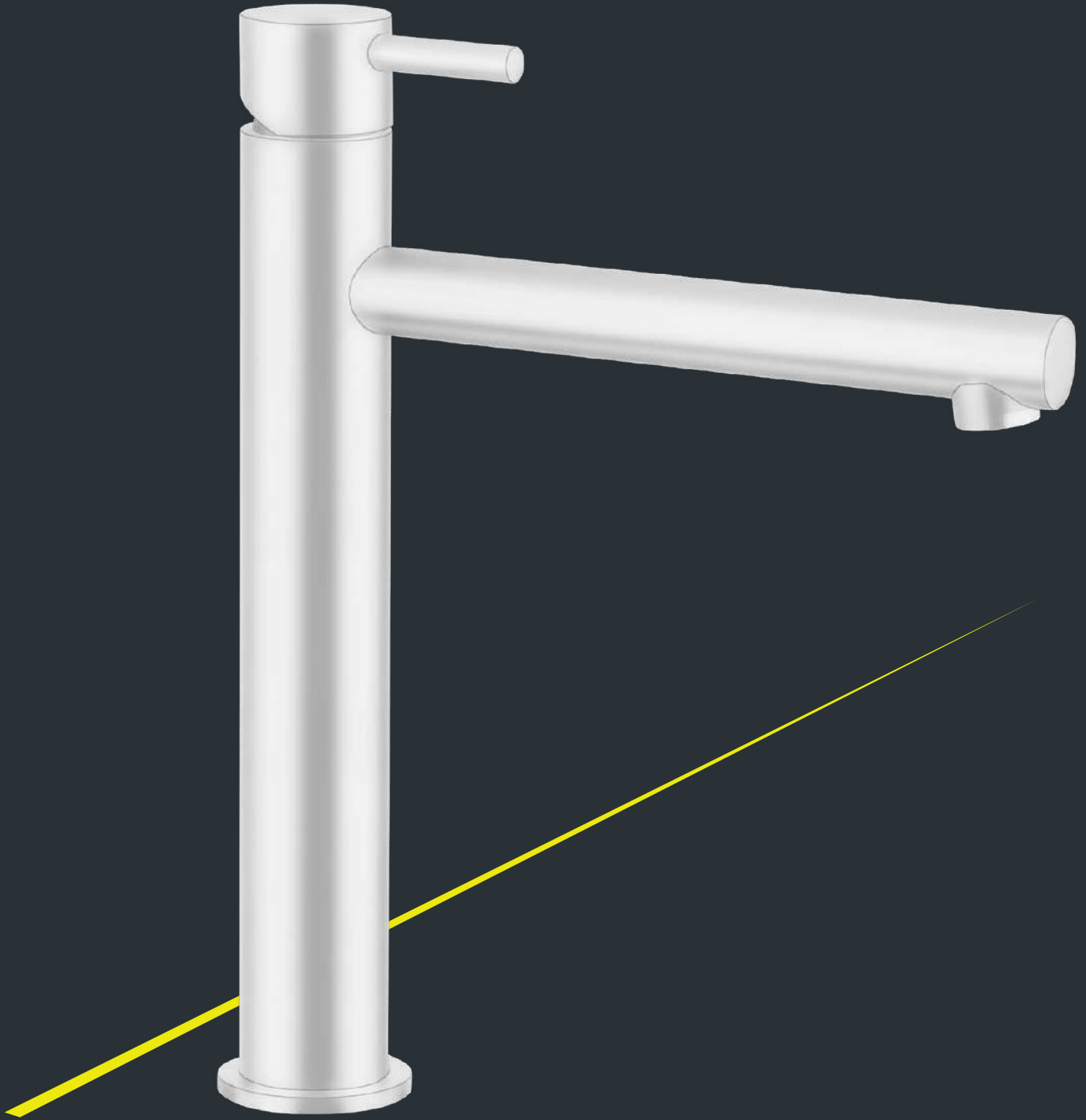

MN 10

Monocomando vasca
Single lever bath mixer without/with shower kit
Einhebelmischbatterie für Wanne ohne/mit kit Handbrause



MN 10 SD - senza kit doccia

NO - nero opaco

BO - bianco opaco

MN 10 DXC - con kit doccia

NO - nero opaco

BO - bianco opaco

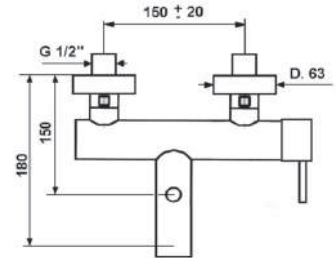
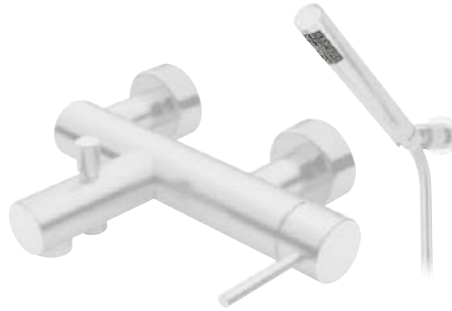
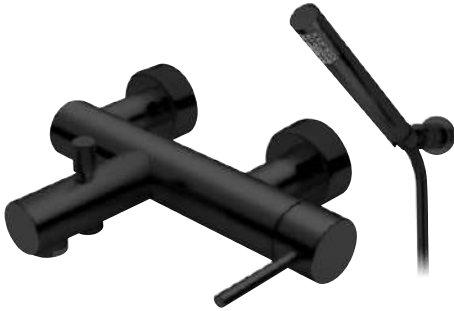

MN 20

Monocomando lavabo con scarico click-clack
Single lever basin mixer with click-clack waste
Einhebelmischbatterie für Waschbecken mit Ablaufventil click-clack



MN 20

NO - nero opaco

BO - bianco opaco

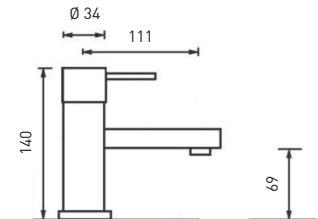

MN 1290

Sifone da arredo in ottone tondo.
Brass syphon chrome.
Siphon.

MN 1290

NO - nero opaco

BO - bianco opaco

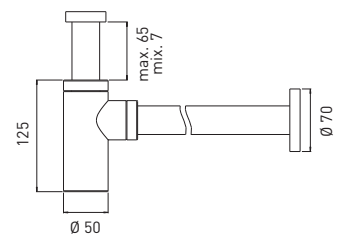

MN 21 | Monocomando lavabo alto con scarico click-clack
Single lever high basin mixer with click-clack waste
Hohe Einhebelmischbatterie für Waschbecken mit Ablaufventil click-clack



MN 21

NO - nero opaco

BO - bianco opaco

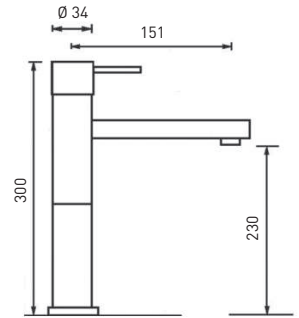

MN 26 | Monocomando lavabo incasso orizzontale senza scarico
Concealed single lever basin mixer (horizontal)
Einhebelmischbatterie für Waschbecken zum horizontalen Einbau ohne Ablauf



MN 26

NO - nero opaco

BO - bianco opaco

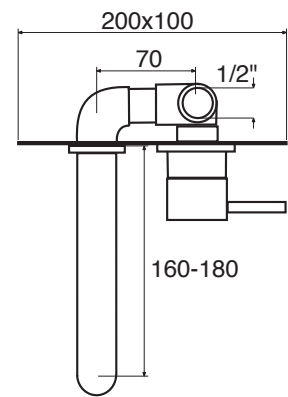

MN 27 | Monocomando lavabo incasso orizzontale senza scarico
Concealed single lever basin mixer (horizontal)
Einhebelmischbatterie für Waschbecken zum horizontalen Einbau ohne Ablauf



MN 27

NO - nero opaco

BO - bianco opaco

NEW

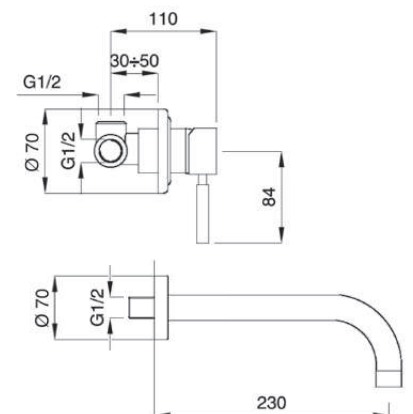

MN 30

Monocomando bidet con scarico click-clack
Single lever bidet mixer with click-clack waste
Einhebelmischbatterie für Bidet mit Ablaufventil click-clack



MN 30

NO - nero opaco

BO - bianco opaco

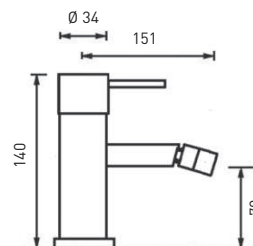

MN 40

Monocomando incasso doccia
Single lever built-in shower mixer
Einhebelmischbatterie für Dusche zum Einbau



MN 40

NO - nero opaco

BO - bianco opaco

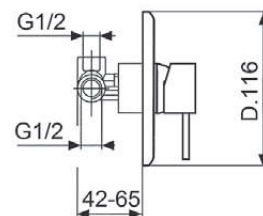

MN 41

Monocomando incasso doccia con deviatore a 2 uscite
Single lever for built-in shower with diverter with 2 outputs
Einhebelmischbatterie für Dusche zum Einbau mit Umschaltventil



MN 41

NO - nero opaco

BO - bianco opaco

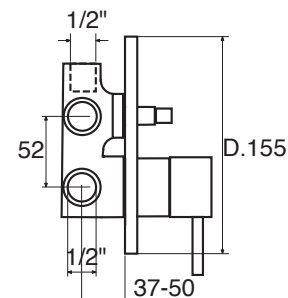

MN 41/3 | Monocomando incasso doccia con deviatore a 3 uscite
Single lever for built-in shower with diverter with 3 outputs
Einhebelmischbatterie für Dusche zum Einbau mit Umschaltventil



MN 41/3

NO - nero opaco

BO - bianco opaco

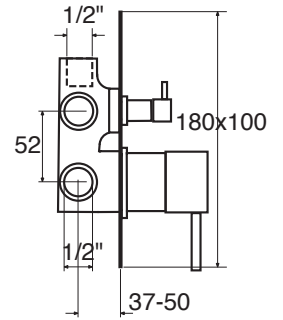

MN 50 | Monocomando esterno doccia
Single lever exterior shower without/with shower kit
Einhebelmischbatterie für Dusche ohne/mit kit Handbrause



MN 50 SD - senza kit doccia

NO - nero opaco

BO - bianco opaco

MN 50 DC - con kit doccia

NO - nero opaco

BO - bianco opaco

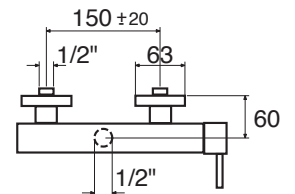
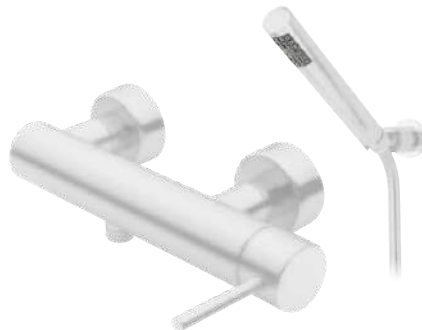
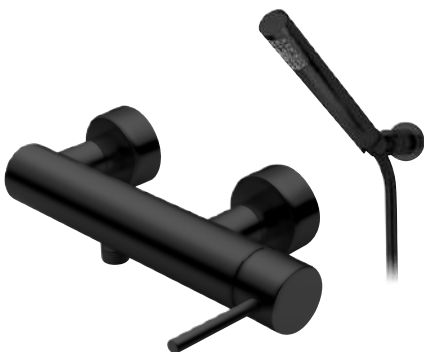

MN 14009/25 | Kit soffione cilindrico diametro mm 250 con MISCELATORE incasso doccia, deviatore a 2 uscite + kit doccia cilindrico con presa acqua, flessibile cm 150 e doccetta cilindrica.
Shower kit with headshower and mixer + water supply with flexible hose and handshower.

MN 14009/25 - KIT COMPLETO

NO - nero opaco

MN 16025

Soffione doccia tondo con braccio da 350 mm.
Shower head, in round shape with shower arm 350 mm.
Riesenbrausekopf mit brausenarm 350 mm.

MN 16025 Ø mm.

NO - nero opaco 250

MN 41

Monocomando incasso doccia con deviatore a 2 uscite.

Single lever for built-in shower with diverter with 2 outputs.

Einhebelmischbatterie für Dusche zum Einbau mit Umschaltventil.

MN 41

NO - nero opaco

MN SA 99

Presa acqua cilindrica in ottone con supporto. Completa di flessibile satilux e doccetta in ABS.

Round water supply with support.
With luxury flexible and shower.

MN SA 99

NO - nero opaco



MN 14009/25 Kit soffione cilindrico diametro mm 250 con MISCELATORE incasso doccia, deviatore a 2 uscite + kit doccia cilindrico con presa acqua, flessibile cm 150 e doccetta cilindrica.
Shower kit with headshower and mixer + water supply with flexible hose and handshower.

MN 14009/25 - KIT COMPLETO

BO - bianco opaco

MN 16025

Soffione doccia tondo con braccio da 350 mm.
Shower head, in round shape with shower arm 350 mm.
Riesenbrausekopf mit brausenarm 350 mm.

MN 16025 Ø mm.

BO - bianco opaco 250

MN 41

Monocomando incasso doccia con deviatore a 2 uscite.
Single lever for built-in shower with diverter with 2 outputs.
Einhebelmischbatterie für Dusche zum Einbau mit Umschaltventil.

MN 41

BO - bianco opaco

MN SA 99

Presa acqua cilindrica in ottone con supporto. Completa di flessibile satilux e doccetta in ABS.
Round water supply with support.
With luxury flexible and shower.

MN SA 99

BO - bianco opaco



MN 5100 | Saliscendi minimalista asta in ottone Ø 20 mm, scorrevole e laterali in ottone, flessibile cm 150, doccia abs.
Round sliding rail, in brass Ø 20 mm, with flexible cm 150 and abs handshower.

MN 5100

NO - nero opaco

BO - bianco opaco

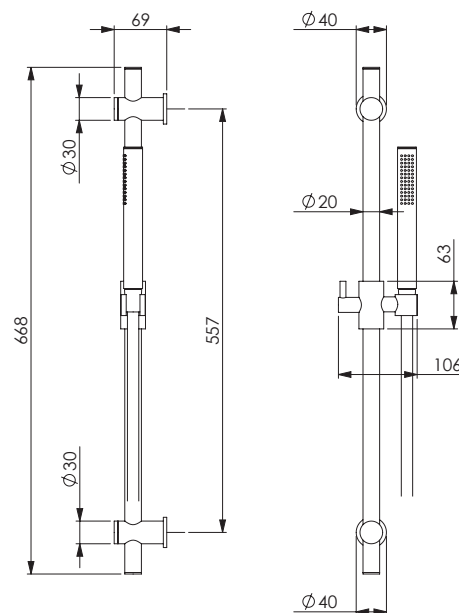

MN IF 98 | Presa acqua cilindrica in ottone.
Round water supply.

MN IF 98

NO - nero opaco

BO - bianco opaco

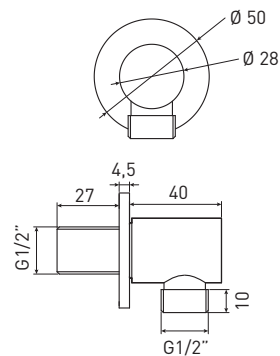

MN 13079/25 ABS

Kit colonna doccia cilindrica con deviatore, soffione ABS diametro mm 250, MISCELATORE cilindrico, flessibile cm 150 e doccetta cilindrica in abs.
Shower columns with diverter, ABS headshower Ø 250 mm, mixer, flexible cm 150 and abs handshower.

MN 13079/25 ABS - KIT COMPLETO

NO - nero opaco

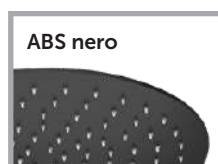

MN 4005 Colonna in alluminio multifunzione anticalcare con miscelatore e getto a cascata.
Antiscale aluminium shower column multifunction with mixer and waterfall jet.

MN 4005

NO - nero opaco

BO - bianco opaco

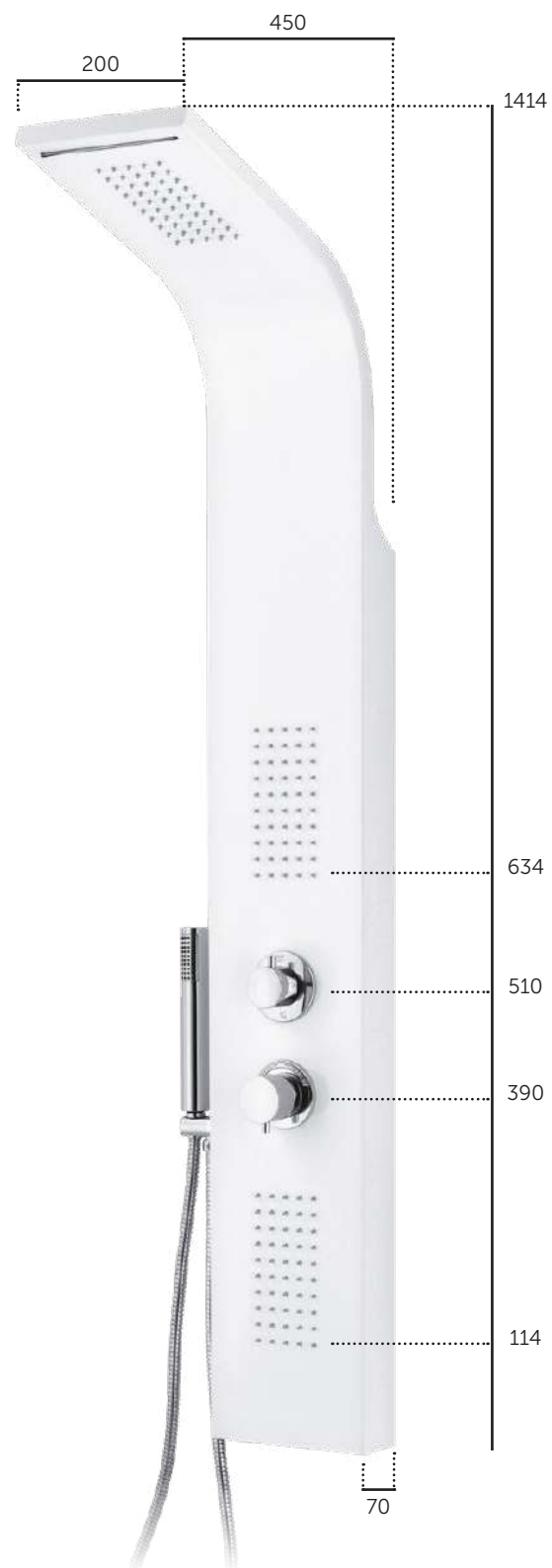
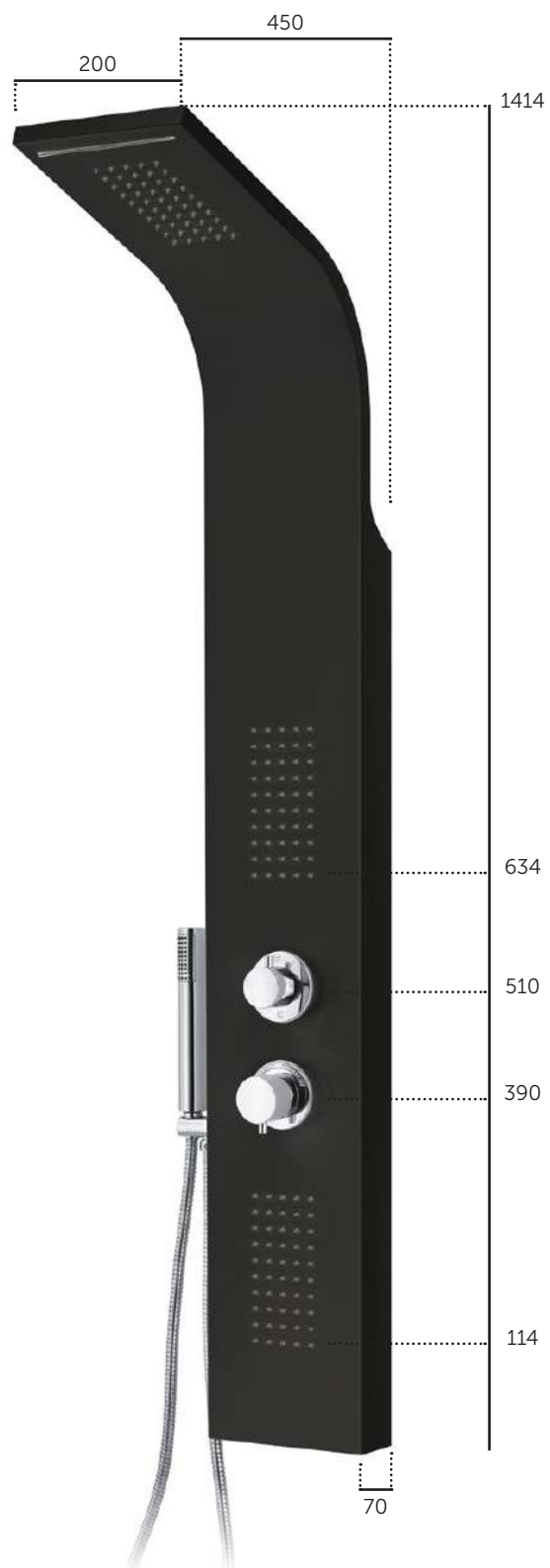

RELAX





RX 10

Monocomando vasca
Single lever bath mixer without/with shower kit
Einhebelmischbatterie für Wanne ohne/mit kit Handbrause

RX 10 SD - senza kit doccia

- CR
- BO - NO
- NI - BR - RA
- GLD - CPR - GNM
- OR

RX 10 DXC - con kit doccia

- CR
- BO - NO
- NI - BR - RA
- GLD - CPR - GNM
- OR

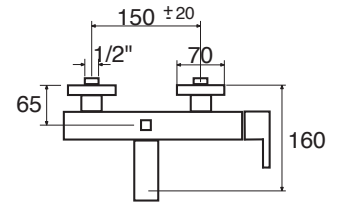

RX 20

Monocomando lavabo con scarico click-clack
Single lever basin mixer with click-clack waste
Einhebelmischbatterie für Waschbecken mit Ablaufventil click-clack

RX 20

- CR
- BO - NO
- NI - BR - RA
- GLD - CPR - GNM
- OR

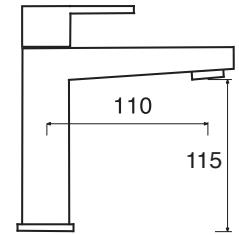

RX 21

Monocomando lavabo alto con scarico click-clack
Single lever higt basin mixer with click-clack waste
Hohe Einhebelmischbatterie für Waschbecken mit Ablaufventil click-clack

RX 21

- CR
- BO - NO
- NI - BR - RA
- GLD - CPR - GNM
- OR

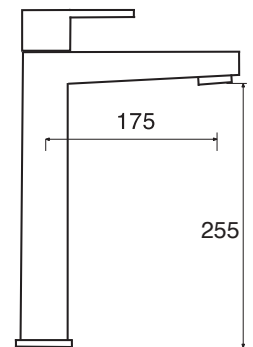

RX 26

Monocomando lavabo incasso orizzontale senza scarico
Concealed single lever basin mixer (horizontal)
Einhebelmischbatterie für Waschbecken zum horizontalen Einbau ohne Ablauf

RX 26

CR

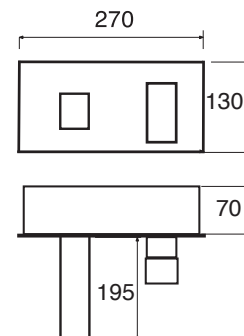

RX 27

Monocomando lavabo incasso orizzontale senza scarico
Concealed single lever basin mixer (horizontal)
Einhebelmischbatterie für Waschbecken zum horizontalen Einbau ohne Ablauf

RX 27

CR

BO - NO

NI - BR - RA

GLD - CPR - GNM

OR

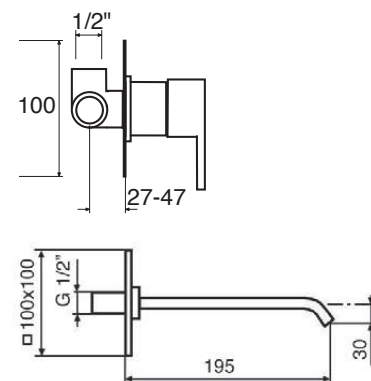
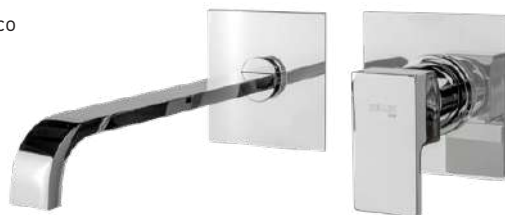

RX 30

Monocomando bidet con scarico click-clack
Single lever bidet mixer with click-clack waste
Einhebelmischbatterie für Bidet mit Ablaufventil click-clack

RX 30

CR

BO - NO

NI - BR - RA

GLD - CPR - GNM

OR

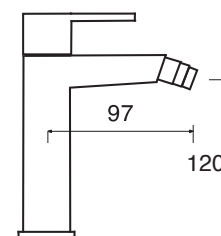



RX 40

Monocomando incasso doccia
Single lever built-in shower mixer
Einhebelmischbatterie für Dusche zum Einbau

RX 40

- _____ CR
- _____ BO - NO
- _____ NI - BR - RA
- _____ GLD - CPR - GNM
- _____ OR

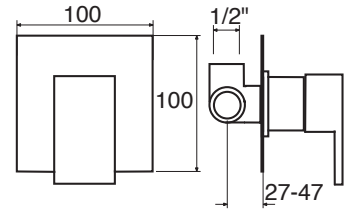

RX 41

Monocomando incasso doccia con deviatore a 2 uscite
Single lever for built-in shower with diverter with 2 outputs
Einhebelmischbatterie für Dusche zum Einbau mit Umschaltventil

RX 41

- _____ CR
- _____ BO - NO
- _____ NI - BR - RA
- _____ GLD - CPR - GNM
- _____ OR

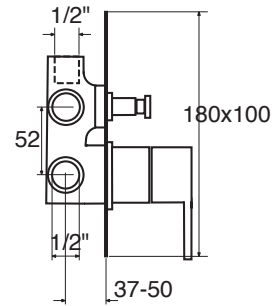

RX 41/3

Monocomando incasso doccia con deviatore a 3 uscite
Single lever for built-in shower with diverter with 3 outputs
Einhebelmischbatterie für Dusche zum Einbau mit Umschaltventil

RX 41/3

- _____ CR
- _____ BO - NO
- _____ NI - BR - RA
- _____ GLD - CPR - GNM
- _____ OR

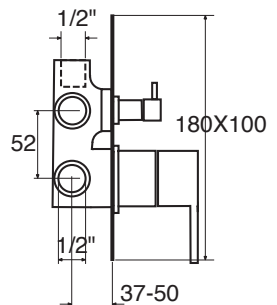
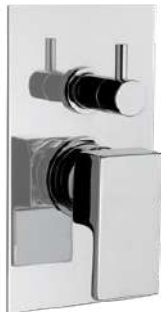

RX 48

Monocomando incasso doccia con deviatore a 2 uscite, presa acqua con doccetta.

Single lever for built-in shower with diverter with 2 output, water supply with shower.

Einhebelmischbatterie für Dusche zum Einbau mit Umschaltventil.

NEW

RX 48

CR
BO - NO
NI - BR - RA
GLD - CPR - GNM
OR

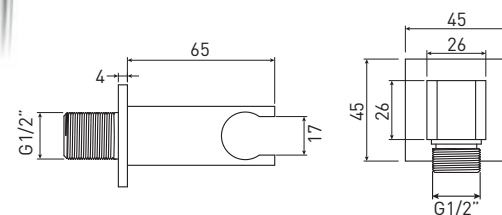
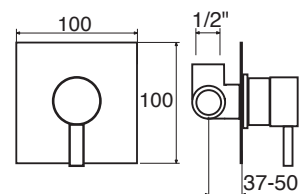
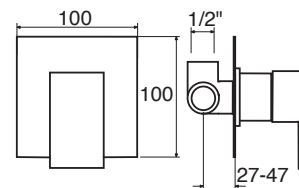

RX 50

Monocomando esterno doccia

Single lever exterior shower without/with shower kit

Einhebelmischbatterie für Dusche ohne/mit kit Handbrause

RX 50 SD - senza kit doccia

CR
BO - NO
NI - BR - RA
GLD - CPR - GNM
OR

RX 50 DC - con kit doccia

CR
BO - NO
NI - BR - RA
GLD - CPR - GNM
OR

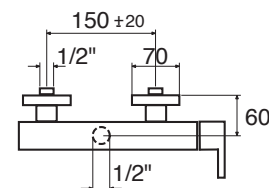

RX 16

Monocomando bordo vasca 4 fori

4-hole bathtub edge single lever

4-Loch-Einhebelmischbatterie für den Badewannenrand

RX 16

CR
Ø 35 mm

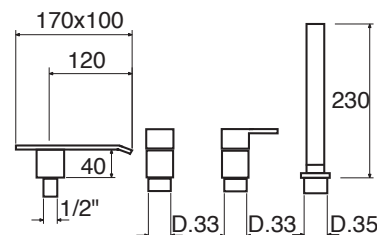



RX 12

Monocomando vasca a colonna
 Column tub mixer
 Säulenmischbatterie für Wanne

RX 12

- _____ CR
- _____ BO - NO
- _____ NI - BR - RA
- _____ GLD - CPR - GNM
- _____ OR

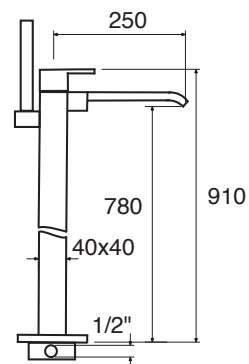
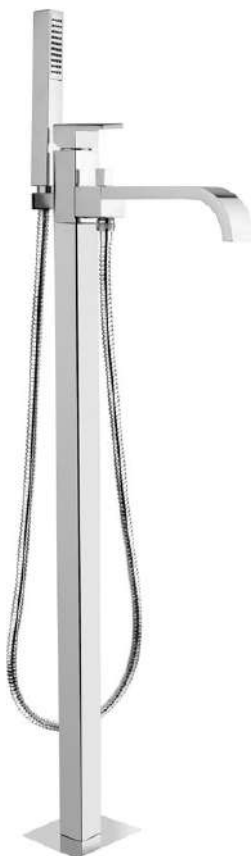

KI 9261

Set **rubinetto** idroscopico in ottone cromato,
 flessibile doppia aggraffatura cm. 120.
 Hydrobrush jet set, brass chrome plated tap,
 flexible hose double lock cm. 120.

KI 9261

- _____ CR
- _____ BO - NO
- _____ BR - RA - NI
- _____ GLD - CPR - GNM
- _____ OR

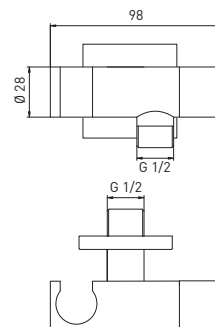

KI 6191

Set **miscelatore** idroscopico in ottone cromato,
 flessibile doppia aggraffatura cm. 120.
 Hydrobrush jet set, brass chrome plated tap,
 flexible hose double lock cm. 120.



KI 6191

- _____ CR
- _____ BO - NO
- _____ BR - RA - NI
- _____ GLD - CPR - GNM
- _____ OR

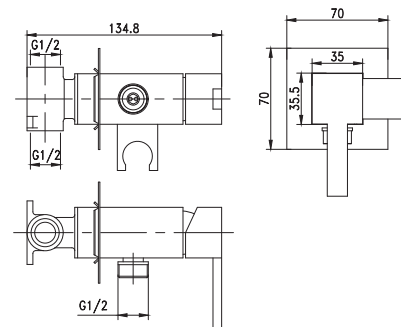

STYLE



SY 10

Monocomando vasca
Single lever bath mixer without/with shower kit
Einhebelmischbatterie für Wanne ohne/mit kit
Handbrause

SY 10 SD - senza kit doccia

CR

SY 10 DXC - con kit doccia

CR

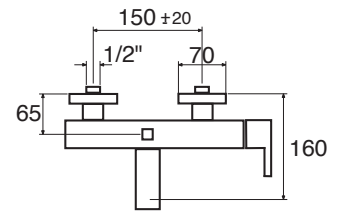

SY 20

Monocomando lavabo con scarico click-clack
Single lever basin mixer with click-clack waste
Einhebelmischbatterie für Waschbecken mit
Ablaufventil click-clack

SY 20

CR

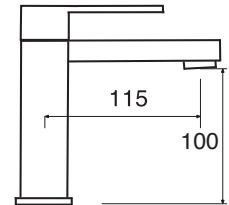

SY 21

Monocomando lavabo alto con scarico click-clack
Single lever high basin mixer with click-clack waste
Hohe Einhebelmischbatterie für Waschbecken mit
Ablaufventil click-clack

SY 21

CR

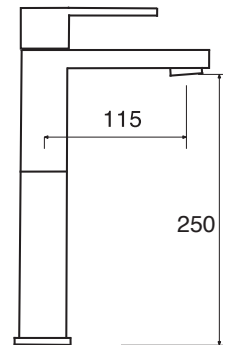

SY 25

Monocomando lavabo con scarico click-clack e
aeratore
Single lever basin mixer with click-clack waste
Einhebelmischbatterie für Waschbecken mit
Ablaufventil click-clack

SY 25

CR

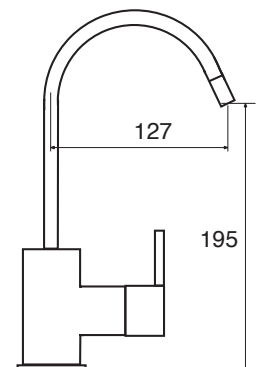

SY 30

Monocomando bidet con scarico click-clack
Single lever bidet mixer with click-clack waste
Einhebelmischbatterie für Bidet mit Ablaufventil click-clack

SY 30

CR

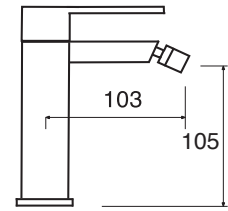

SY 35

Monocomando bidet con scarico click-clack e aeratore
Single lever bidet mixer with click-clack waste and aerator
Einhebelmischbatterie für Bidet mit Ablaufventil click-clack

SY 35

CR

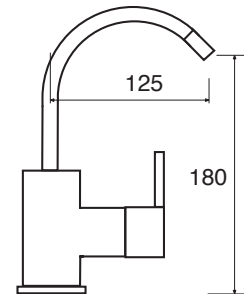

SY 40

Monocomando incasso doccia
Single lever built-in shower mixer
Einhebelmischbatterie für Dusche zum Einbau

SY 40

CR

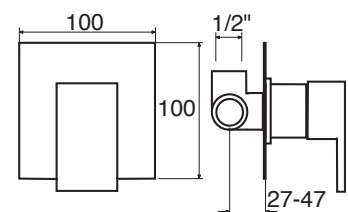

SY 41

Monocomando incasso doccia con deviatore a 2 uscite
Single lever for built-in shower with diverter with 2 outputs
Einhebelmischbatterie für Dusche zum Einbau mit Umschaltventil

SY 41

CR

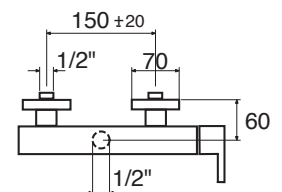

SY 41/3

Monocomando incasso doccia con deviatore a 3 uscite
Single lever for built-in shower with diverter with 3 outputs
Einhebelmischbatterie für Dusche zum Einbau mit Umschaltventil

SY 41/3

CR

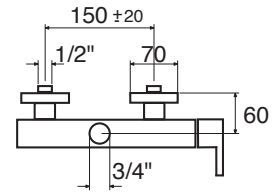
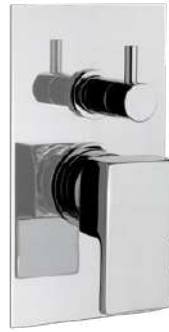

SY 50

Monocomando esterno doccia
Single lever exterior shower without/with shower kit
Einhebelmischbatterie für Dusche ohne/mit kit Handbrause

SY 50 SD - senza kit doccia

CR

SY 50 DC - con kit doccia

CR

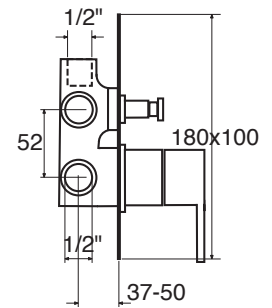

SY 16

Monocomando bordo vasca 4 fori
4-hole bathtub edge single lever
4-Loch-Einhebelmischbatterie für den Badewannenrand

SY 16

CR

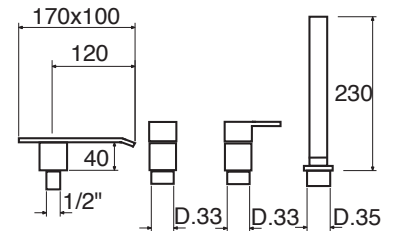

SY 12

Monocomando vasca a colonna
Column tub mixer
Säulenmischbatterie für Wanne

SY 12

CR

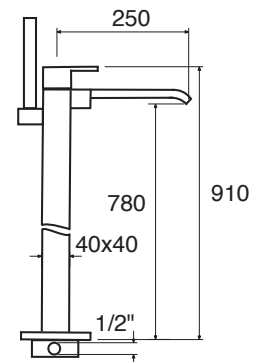
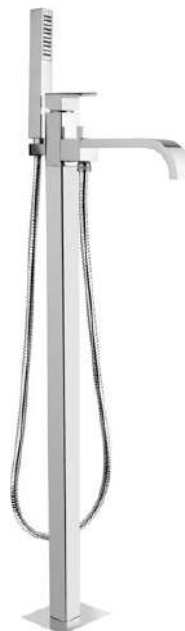

SATURNINO





SA 10

Monocomando vasca
 Single lever bath mixer without/with shower kit
 Einhebelmischbatterie für Wanne ohne/mit kit Handbrause

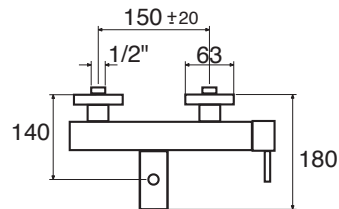

SA 10 SD - senza kit doccia

- _____ CR
- _____ BO - NO
- _____ NI
- _____ BR - RA
- _____ GLD - CPR - GNM
- _____ OR

SA 10 DXC - con kit doccia

- _____ CR
- _____ BO - NO
- _____ NI
- _____ BR - RA
- _____ GLD - CPR - GNM
- _____ OR

SA 20

Monocomando lavabo con scarico click-clack
 Single lever basin mixer with click-clack waste
 Einhebelmischbatterie für Waschbecken mit Ablaufventil click-clack

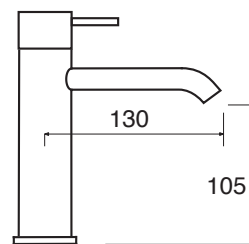

SA 20

- _____ CR
- _____ BO - NO
- _____ NI - BR - RA
- _____ GLD - CPR - GNM
- _____ OR



SS 20 SLIM

Monocomando lavabo con scarico pop-up
 Single lever basin mixer with pop-up waste
 Einhebelmischbatterie für Waschbecken mit Ablaufventil pop-up

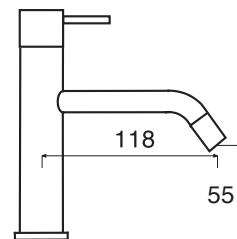

SS 20 SLIM

- _____ CR
-

SA 23

Monocomando lavabo con scarico click-clack
 Single lever basin mixer with click-clack waste
 Einhebelmischbatterie für Waschbecken mit Ablaufventil click-clack

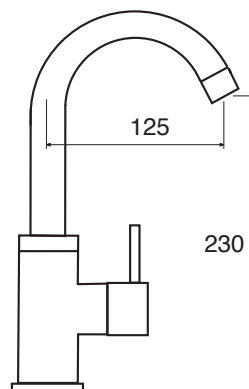

SA 23

- _____ CR
- _____ BO - NO
- _____ NI - BR - RA
- _____ GLD - CPR - GNM
- _____ OR



SA 21

Monocomando lavabo alto con scarico click-clack
Single lever high basin mixer with click-clack waste
Hohe Einhebelmischbatterie für Waschbecken mit Ablaufventil click-clack

SA 21

CR
 BO - NO
 NI - BR - RA
 GLD - CPR - GNM
 OR



Ø 35 mm

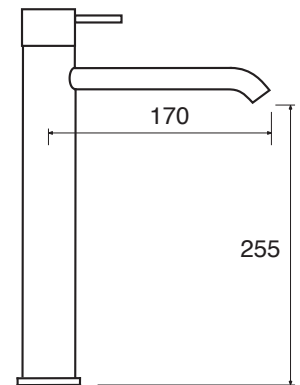

SS 21 SLIM

Monocomando lavabo alto con scarico click-clack
Single lever high basin mixer with click-clack waste
Hohe Einhebelmischbatterie für Waschbecken mit Ablaufventil click-clack

SS 21 SLIM

CR



Ø 25 mm

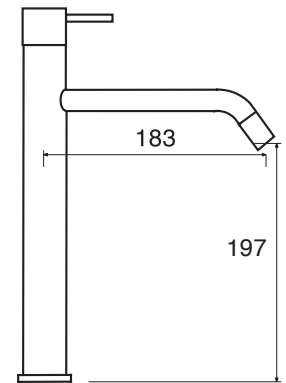

SA 26

Monocomando lavabo incasso orizzontale senza scarico
Concealed single lever basin mixer (horizontal)
Einhebelmischbatterie für Waschbecken zum horizontalen Einbau ohne Ablauf

SA 26

CR



Ø 35 mm

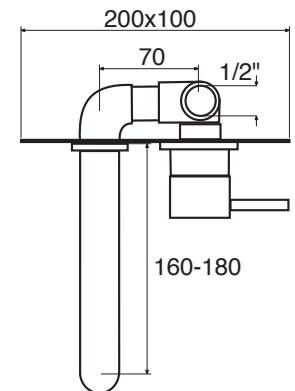

SA 27

Monocomando lavabo incasso orizzontale senza scarico
Concealed single lever basin mixer (horizontal)
Einhebelmischbatterie für Waschbecken zum horizontalen Einbau ohne Ablauf

SA 27

CR
 BO - NO
 NI - BR - RA
 GLD - CPR - GNM
 OR



Ø 35 mm

NEW

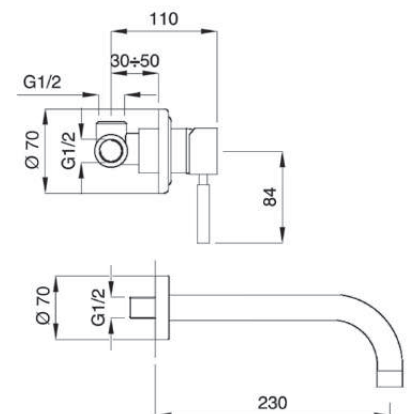



SA 30

Monocomando bidet con scarico click-clack
Single lever bidet mixer with click-clack waste
 Einhebelmischbatterie für Bidet mit Ablaufventil
 click-clack

SA 30

CR
 BO - NO
 NI - BR - RA
 GLD - CPR - GNM
 OR

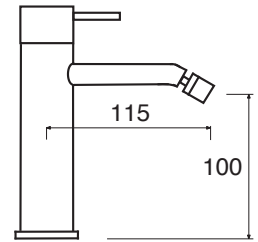

SS 30 SLIM

Monocomando bidet con scarico pop-up
Single lever bidet mixer with pop-up waste
 Einhebelmischbatterie für Bidet mit Ablaufventil
 pop-up

SS 30 SLIM

CR
 ø 25 mm

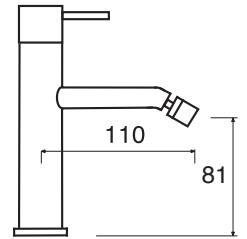

SA 33

Monocomando bidet con scarico click-clack
Single lever bidet mixer with click-clack waste
 Einhebelmischbatterie für Bidet mit Ablaufventil
 click-clack

SA 33

CR
 BO - NO
 NI - BR - RA
 GLD - CPR - GNM
 OR

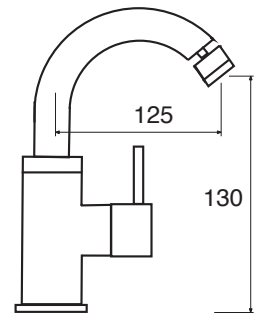

SA 40

Monocomando incasso doccia
Single lever built-in shower mixer
 Einhebelmischbatterie für Dusche zum Einbau

SA 40

CR
 BO - NO
 NI - BR - RA
 GLD - CPR - GNM
 OR

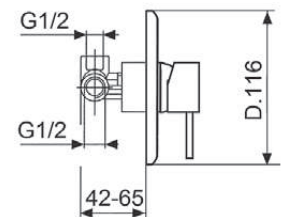

SA 41

Monocomando incasso doccia con deviatore a 2 uscite
Single lever for built-in shower with diverter with 2 outputs
Einhebelmischbatterie für Dusche zum Einbau mit Umschaltventil

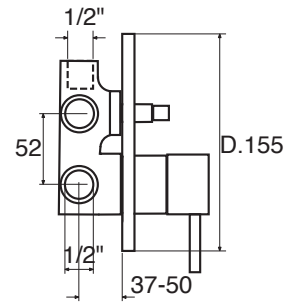

SA 41

CR
 BO - NO
 NI - BR - RA
 GLD - CPR - GNM
 OR

SA 41/3

Monocomando incasso doccia con deviatore a 3 uscite
Single lever for built-in shower with diverter with 3 outputs
Einhebelmischbatterie für Dusche zum Einbau mit Umschaltventil

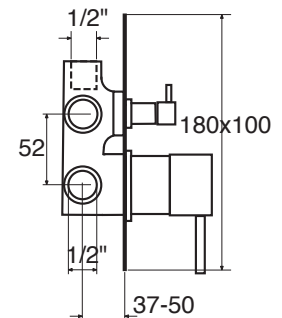

SA 41/3

CR
 BO - NO
 NI - BR - RA
 GLD - CPR - GNM
 OR

SA 48

Monocomando incasso doccia con deviatore a 2 uscite,
 presa acqua con doccetta.
*Single lever for built-in shower with diverter with 2 output,
 water supply with shower.*
*Einhebelmischbatterie für Dusche zum Einbau mit
 Umschaltventil.*

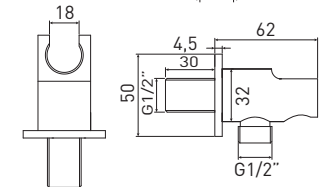
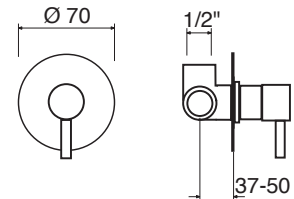
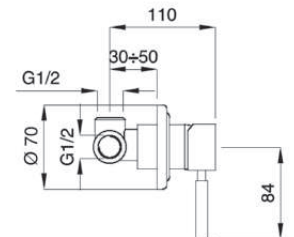

SA 48

CR
 BO - NO
 NI - BR - RA
 GLD - CPR - GNM
 OR

SA 50

Monocomando esterno doccia
Single lever exterior shower without/with shower kit
Einhebelmischbatterie für Dusche ohne/mit kit Handbrause

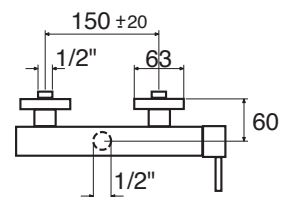

SA 50 SD - senza kit doccia

CR
 BO - NO
 NI - BR - RA
 GLD - CPR - GNM
 OR

SA 50 DC - con kit doccia

CR
 BO - NO
 NI - BR - RA
 GLD - CPR - GNM
 OR



SA 60 CS 20

Monocomandoavello a parete
Single lever wall sink mixer
Einhebelmischer wandspültischbatterie

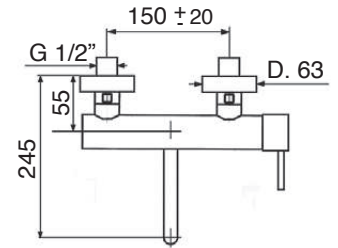

SA 60 CS 20

CR



SA 15

Monocomando bordo vasca 4 fori
Single lever 4 hole deck mtd set
Wannenrandeinhebelmischer-4-loch

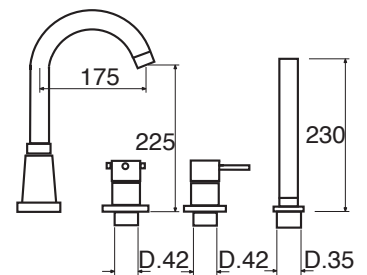

SA 15

CR



SA 16

Monocomando bordo vasca 4 fori a cascata
Single lever tub edge 4 holes cascade
4-Loch-Einhebelmischbatterie für den
Badewannenrand mit Kaskadenauslauf

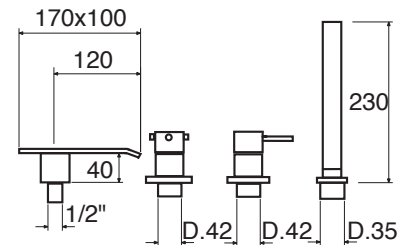

SA 16

CR



SA 45

Deviatore incasso a 2-3 uscite
Built-in diverter with 2-3 outputs
Deviator vertieft

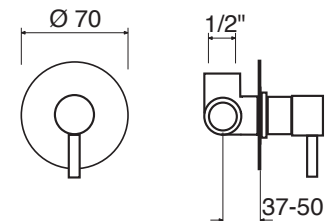

SA 45/2 uscite

CR

BO - NO

NI - BR - RA

GLD - CPR - GNM

OR

SA 45/3 uscite

CR

BO - NO

NI - BR - RA

GLD - CPR - GNM

OR



SA 12

Monocomando vasca a colonna cilindrica
 Mixer tub with cylindrical stand
 Badewannenmischbatterie mit zylindrischer Säule

SA 12

CR
 BO - NO
 NI - BR - RA
 GLD - CPR - GNM

OR

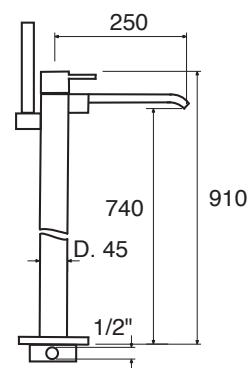

SA 19

Coppia colonne da terra per vasca esterna
 Pair of columns for bathtub group
 Standrohrpaar für freistehende Badewanne,
 3/4"-Konusaufnahme

SA 19

CR
 BO - NO
 NI - BR - RA
 GLD - CPR - GNM

OR

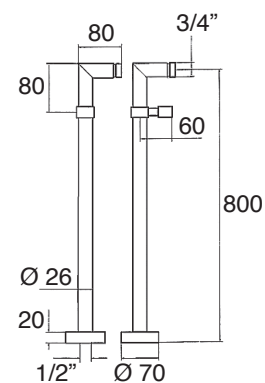
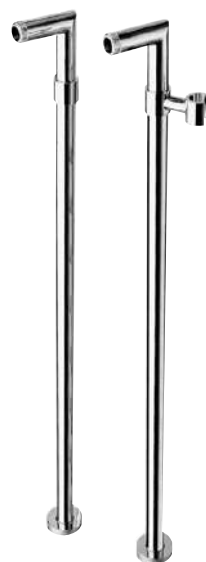

SA 5100

Saliscendi minimalista in ottone, scorrevole e
 doccetta abs.
 Round sliding rail.

SA 5100

CR
 BO - NO
 NI - BR - RA





KI 9121

Set **rubinetto** idroscopino in ottone cromato, flessibile doppia aggraffatura cm. 120.

Hydrobrush jet set, brass chrome plated tap, flexible hose double lock cm. 120.

KI 9121

CR
BO - NO
BR - RA - NI
GLD - CPR - GNM
OR

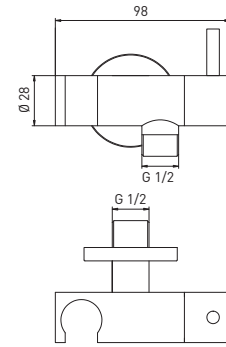

KI 9181

Set **miscelatore** idroscopino in ottone cromato, flessibile doppia aggraffatura cm. 120.

Hydrobrush jet set, brass chrome plated tap, flexible hose double lock cm. 120.

NEW

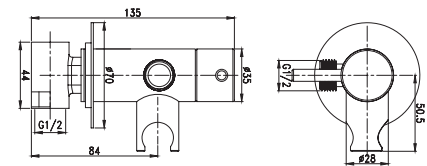

KI 9181

CR
BO - NO
BR - RA - NI
GLD - CPR - GNM
OR

SA 1290

Sifone da arredo in ottone tondo.

Brass syphon chrome.

Siphon.

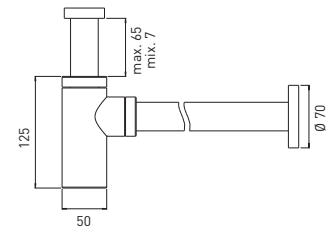

SA 1290

CR
BO - NO
NI - BR - RA
GLD - CPR - GNM
OR



SA 14009/25

Kit soffione cilindrico diametro mm 250 con MISCELATORE incasso doccia, deviatore a 2 uscite + kit doccia cilindrico con presa acqua, flessibile cm 150 e doccetta cilindrica.

Shower kit with headshower and mixer + water supply with flexible hose and handshower.

SA 14009/25 - KIT COMPLETO

CR
BO - NO
NI
BR - RA
GLD - CPR - GNM
OR

SA 16025

Soffione doccia tondo con braccio da 350 mm.
Shower head, in round shape with shower arm 350 mm.
Riesenbrausekopf mit brausenarm 350 mm.

SA 16025	Ø mm.
CR	250
BO - NO	250
NI	250
BR - RA	250
GLD - CPR - GNM	250
OR	250

SA 41

Monocomando incasso doccia con deviatore a 2 uscite.

Single lever for built-in shower with diverter with 2 outputs.

Einhebelmischbatterie für Dusche zum Einbau mit Umschaltventil.

SA 41

CR
BO - NO
NI - BR - RA
GLD - CPR - GNM
OR

SA 99

Presa acqua cilindrica in ottone con supporto. Completa di flessibile satilux e doccetta in ABS.

Round water supply with support.

With luxury flexible and shower.

SA 99

CR
BO - NO
NI
BR - RA
GLD - CPR - GNM
OR





SA 14010/25

Kit soffione cilindrico diametro mm 250 con MISCELATORE incasso doccia, deviatore a 2 uscite + kit doccia cilindrico con presa acqua, flessibile cm 150 e doccetta cilindrica.
Shower kit with headshower and mixer + water supply with flexible hose and handshower.

SA 14010/25 - KIT COMPLETO

CR
BO - NO
NI
BR - RA
GLD - CPR - GNM
OR

SA 16025

Soffione doccia tondo con braccio da 350 mm.
Shower head, in round shape with shower arm 350 mm.
Riesenbrausekopf mit brausenarm 350 mm.

SA 16025	Ø mm.
CR	250
BO - NO	250
NI	250
BR - RA	250
GLD - CPR - GNM	250
OR	250

SA 99

Presa acqua cilindrica in ottone con supporto.
 Completa di flessibile satilux e doccetta in ABS.
Round water supply with support.
With luxury flexible and shower.

SA 99

CR
BO - NO
NI
BR - RA
GLD - CPR - GNM
OR

SA 44

Incasso doccia a doppia uscita esterno senza deviatore estremamente innovativo e molto facile da utilizzare.
 Con un semplice movimento rotatorio della leva si passa velocemente dal soffione alla doccetta e viceversa. La cartuccia a dischi ceramici utilizzata è del tipo a "risparmio energetico" infatti, nelle prime fasi dell'utilizzo del soffione o della doccetta, l'acqua calda non viene utilizzata.
A highly innovative and user friendly built-in shower mixer with two outlets without diverter. By simply rotating the lever water swiftly goes from the showerhead to the handspray and back to the showerhead. Fitted with a water saving ceramic disc cartridge it does not make use of hot water in the early stage of activation of the showerhead and the handspray.

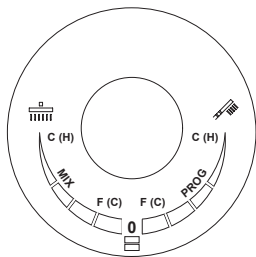

SA 44

CR
BO - NO
NI - BR - RA
GLD - CPR - GNM
OR



SQUARE



NEW

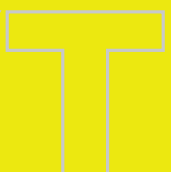

NEW

SQ 10 NO

Monocomando vasca
Single lever bath mixer without/with shower kit
Einhebelmischbatterie für Wanne ohne/mit kit
Handbrause

SQ 10 NO SD - senza kit doccia

NO

SQ 10 NO DXC - con kit doccia

NO

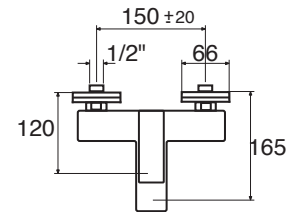

SQ 20 NO

Monocomando lavabo con scarico pop-up
Single lever basin mixer with pop-up waste
Einhebelmischbatterie für Waschbecken mit
Ablaufventil pop-up

SQ 20 NO

NO

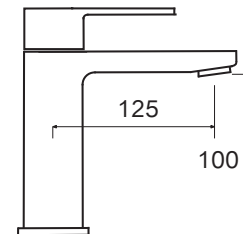

SQ 21 NO

Monocomando lavabo alto con scarico click-clack
Single lever high basin mixer with click-clack waste
Hohe Einhebelmischbatterie für Waschbecken mit
Ablaufventil click-clack

SQ 21 NO

NO

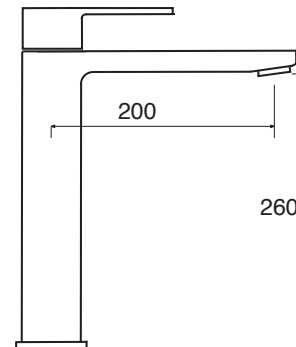

SQ 30 NO

Monocomando bidet con scarico pop-up
Single lever bidet mixer with pop-up waste
Einhebelmischbatterie für Bidet mit Ablaufventil
pop-up

SQ 30 NO

NO

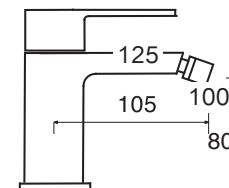

SQ 40 NO

Monocomando incasso doccia
Single lever built-in shower mixer
Einhebelmischbatterie für Dusche zum Einbau

SQ 40 NO

NO

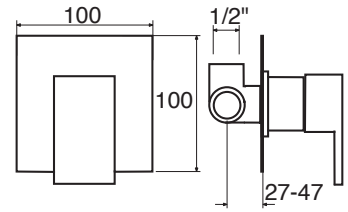

SQ 41 NO

Monocomando incasso doccia con deviatore a 2 uscite
Single lever for built-in shower with diverter with 2 outputs
Einhebelmischbatterie für Dusche zum Einbau mit Umschaltventil

SQ 41 NO

NO

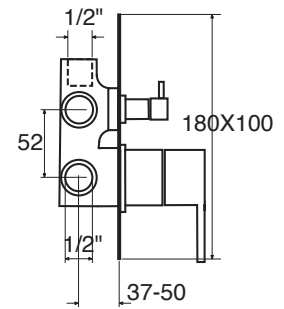

SQ 50 NO

Monocomando esterno doccia
Single lever exterior shower without/with shower kit
Einhebelmischbatterie für Dusche ohne/mit kit Handbrause

SQ 50 NO SD - senza kit doccia

NO

SQ 50 NO DC - con kit doccia

NO

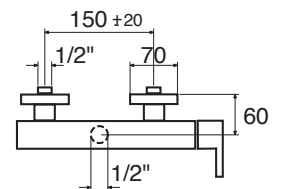

SQ 70 NO

Monocomando cucina canna alta
One-hole sink mixer, high spout
Küchen-Einhebelmischbatterie mit hohem Auslauf

SQ 70 NO

NO

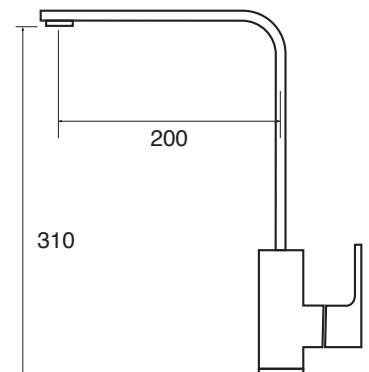

SQ 14019/25 NO

Kit soffione quadrato mm 250x250 con MISCELATORE incasso doccia, deviatore a 2 uscite + kit doccia quadrato con presa acqua, flessibile cm 150 e doccetta quadrata.
Shower kit with headshower and mixer + water supply with flexible hose and handshower.

SQ 14019/25 NO - KIT COMPLETO

NO

SQ 17025 NO

Soffione doccia quadro con braccio da 350 mm.
Shower head, in shape with shower arm 350 mm.
Riesenbrausekopf mit brausenarm 350 mm.

SQ 17025 NO Ø mm.

NO 250

SQ 41 NO

Monocomando incasso doccia con deviatore a 2 uscite.

Single lever for built-in shower with diverter with 2 outputs.

Einhebelmischbatterie für Dusche zum Einbau mit Umschaltventil.

SQ 41 NO

NO

SQ 99 NO

Presa acqua quadrata in ottone con supporto.

Completa di flessibile satilux e doccetta.

Square water supply with support.

With luxury flexible and shower.

SQ 99 NO

NO



SQ 13111/25 NO

Kit colonna doccia cilindrica con soffione quadrato mm 250x250, MISCELATORE quadrato dotato di deviatore, flessibile cm 150 e doccetta quadrata.
Shower columns with headshower 250x250 mm, mixer with diverter, flexible cm 150 and handshower.

SQ 13111/25 NO soffione
NO **ottone**



NEW

SQ 5100 NO

Saliscendi minimalista asta in ottone quadrata, flessibile cm 150, doccetta quadrata.

Sliding rail, in brass, with flexible cm 150 and handshower.

SQ 5100 NO

NO

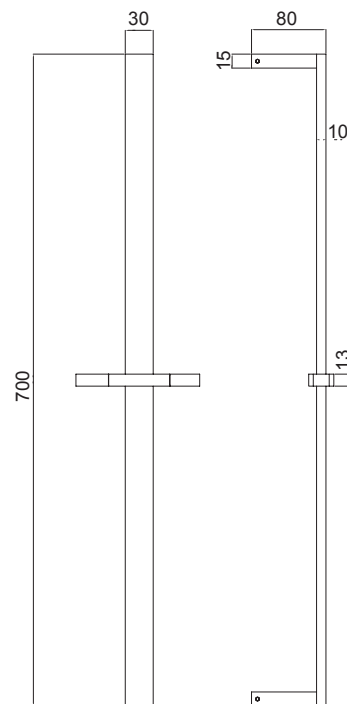

SQ 98 NO

Presacqua cilindrica in ottone.

Round water supply.

SQ 98 NO

NO

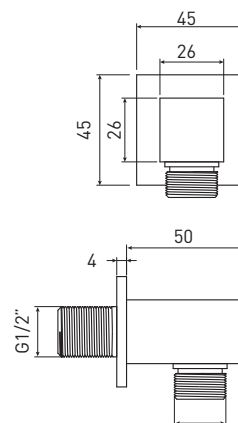

SQUARE







CR NI

SQ 10

Monocomando vasca
 Single lever bath mixer without/with shower kit
 Einhebelmischbatterie für Wanne ohne/mit
 Handbrause

SQ 10 SD - senza kit doccia

CR
 NI

SQ 10 DXC - con kit doccia

CR
 NI

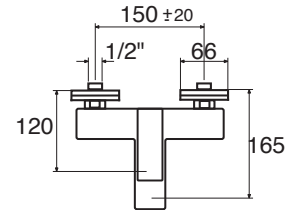

SQ 20

Monocomando lavabo con scarico pop-up
 Single lever basin mixer with pop-up waste
 Einhebelmischbatterie für Waschbecken mit
 Ablaufventil pop-up

SQ 20

CR
 NI

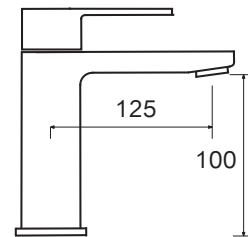

SQ 21

Monocomando lavabo alto con scarico click-clack
 Single lever high basin mixer with click-clack waste
 Hohe Einhebelmischbatterie für Waschbecken mit
 Ablaufventil click-clack

SQ 21

CR
 NI

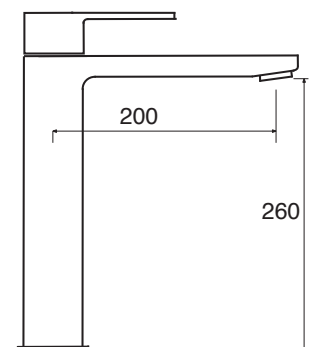



CR

NI

SQ 30

Monocomando bidet con scarico pop-up
Single lever bidet mixer with pop-up waste
Einhebelmischbatterie für Bidet mit Ablaufventil
pop-up

SQ 30

CR

NI

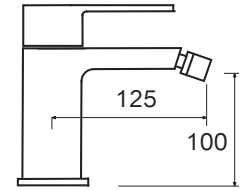

SQ 40

Monocomando incasso doccia
Single lever built-in shower mixer
Einhebelmischbatterie für Dusche zum Einbau

SQ 40

CR

NI

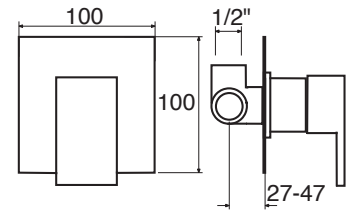

SQ 41

Monocomando incasso doccia con deviatore a 2 uscite
Single lever for built-in shower with diverter with 2 outputs
Einhebelmischbatterie für Dusche zum Einbau mit
Umschaltventil

SQ 41

CR

NI

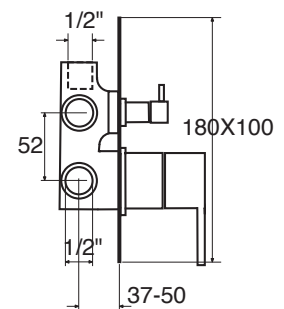

SQ 50

Monocomando esterno doccia
Single lever exterior shower without/with shower kit
Einhebelmischbatterie für Dusche ohne/mit kit
Handbrause

SQ 50 SD - senza kit doccia

CR

NI

SQ 50 DC - con kit doccia

CR

NI

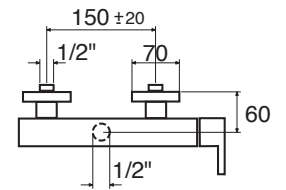

SQ 70

Monocomando cucina canna alta
One-hole sink mixer, high spout
Küchen-Einhebelmischbatterie mit hohem
Auslauf

SQ 70

CR

NI

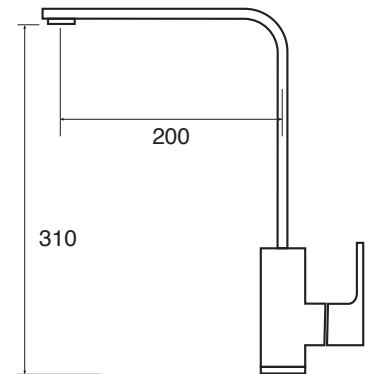

SKY



NEW



CR



NI

NEW**SK 10**

Monocomando vasca

Single lever bath mixer without/with shower kit

Einhebelmischbatterie für Wanne ohne/mit kit

Handbrause

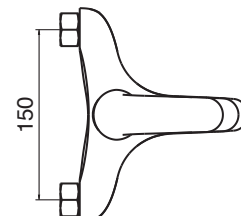
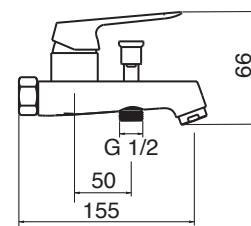
**SK 10 SD** - senza kit doccia

CR

NI

SK 10 DXC - con kit doccia

CR

NI



Ø 35 mm

SK 20

Monocomando lavabo con scarico pop-up

Single lever basin mixer with pop-up waste

Einhebelmischbatterie für Waschbecken mit

Ablaufventil pop-up

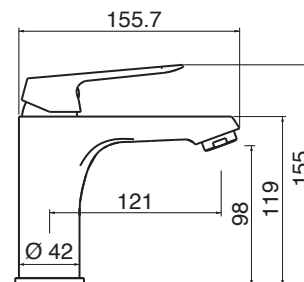
**SK 20**

CR

NI



Ø 35 mm

SK 21

Monocomando lavabo alto con scarico pop-up

Single lever high basin mixer with pop-up waste

Hohe Einhebelmischbatterie für Waschbecken mit

Ablaufventil pop-up

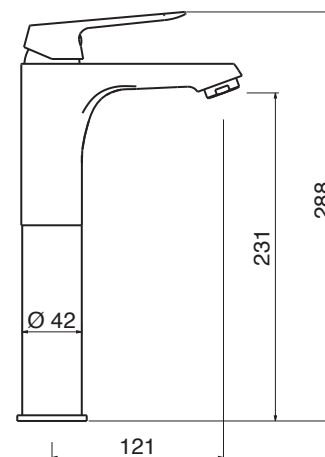
**SK 21**

CR

NI



Ø 35 mm

SK 30

Monocomando bidet con scarico pop-up
 Single lever bidet mixer with pop-up waste
 Einhebelmischbatterie für Bidet mit Ablaufventil pop-up

SK 30

CR
 NI

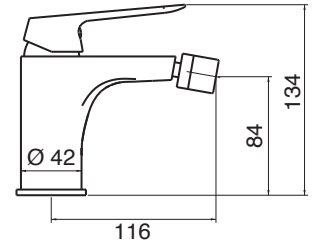

SK 40

Monocomando incasso doccia
 Single lever built-in shower mixer
 Einhebelmischbatterie für Dusche zum Einbau

SK 40

CR
 NI

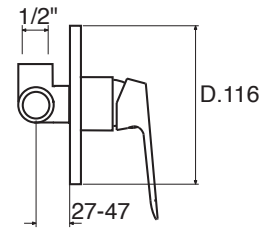

SK 41

Monocomando incasso doccia con deviatore a 2 uscite
 Single lever for built-in shower with diverter with 2 outputs
 Einhebelmischbatterie für Dusche zum Einbau mit Umschaltventil

SK 41

CR
 NI

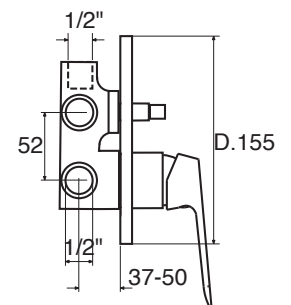



CR



NI

NEW

SK 50

Monocomando esterno doccia

Single lever exterior shower without/with shower kit

Einhebelmischbatterie für Dusche ohne/mit kit

Handbrause

SK 50 SD - senza kit doccia

CR

NI

SK 50 DC - con kit doccia

CR

NI



Ø 35 mm

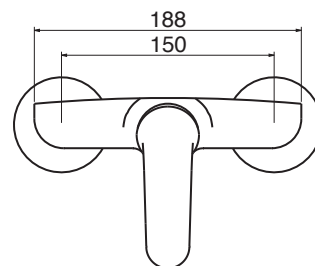
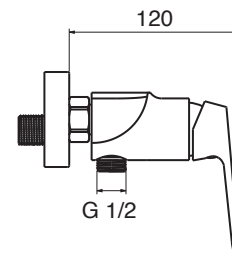

SK 70 CSQ

Monocomando cucina canna alta

One-hole sink mixer, high spout

Küchen-Einhebelmischbatterie mit hohem

Auslauf

SK 70 CSQ

CR

NI



Ø 35 mm

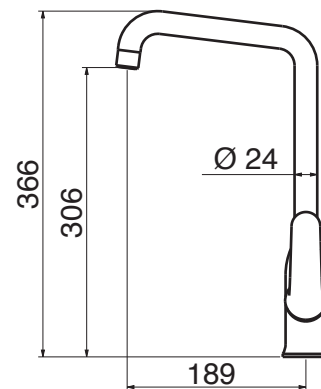

WINTER



NEW

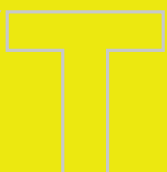

NEW

WN 10 NO

Monocomando vasca
Single lever bath mixer without/with shower kit
Einhebelmischbatterie für Wanne ohne/mit kit
Handbrause

WN 10 NO SD - senza kit doccia

NO

WN 10 NO DXC - con kit doccia

NO

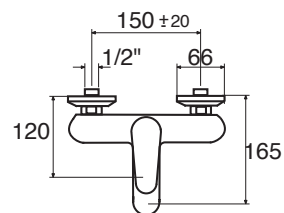

WN 20 NO

Monocomando lavabo con scarico pop-up
Single lever basin mixer with pop-up waste
Einhebelmischbatterie für Waschbecken mit
Ablaufventil pop-up

WN 20 NO

NO

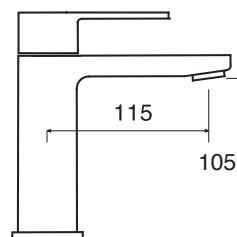

WN 21 NO

Monocomando lavabo alto con scarico pop-up
Single lever high basin mixer with pop-up waste
Hohe Einhebelmischbatterie für Waschbecken mit
Ablaufventil pop-up

WN 21 NO

NO

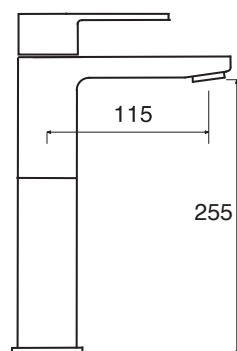

WN 30 NO

Monocomando bidet con scarico pop-up
 Single lever bidet mixer with pop-up waste
 Einhebelmischbatterie für Bidet mit Ablaufventil pop-up

WN 30 NO

NO

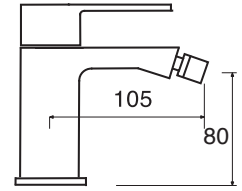

WN 40 NO

Monocomando incasso doccia
 Single lever built-in shower mixer
 Einhebelmischbatterie für Dusche zum Einbau

WN 40 NO

NO

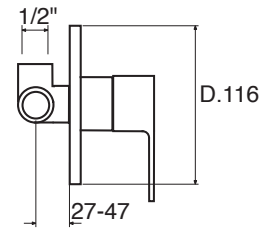

WN 41 NO

Monocomando incasso doccia con deviatore a 2 uscite
 Single lever for built-in shower with diverter with 2 outputs
 Einhebelmischbatterie für Dusche zum Einbau mit Umschaltventil

WN 41 NO

NO

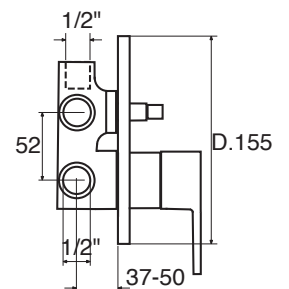

NEW

WN 50 NO

Monocomando esterno doccia
Single lever exterior shower without/with shower kit
Einhebelmischbatterie für Dusche ohne/mit kit
Handbrause

WN 50 NO SD - senza kit doccia

NO

WN 50 NO DC - con kit doccia

NO

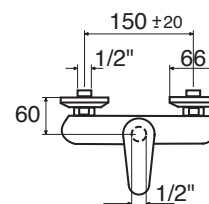

WN 70 CAO NO

Monocomando cucina canna alta
One-hole sink mixer, high spout
Küchen-Einhebelmischbatterie mit hohem
Auslauf

WN 70 CAO NO

NO



WN 22 NO

Monocomando lavabo a colonna con scarico
click clack
Single lever basin mixer with click clack waste
Einhebelmischbatterie für Waschbecken mit
Ablaufventil click clack

WN 22 NO

NO

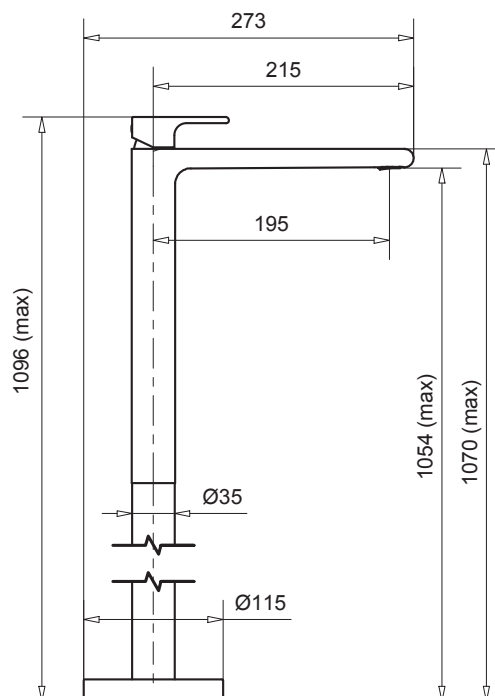

WN 14009/25 NO

Kit soffione cilindrico diametro mm 250 con MISCELATORE incasso doccia, deviatore a 2 uscite + kit doccia cilindrico con presa acqua, flessibile cm 150 e doccetta cilindrica.

Shower kit with headshower and mixer + water supply with flexible hose and handshower.

WN 14009/25 NO- KIT COMPLETO

NO

WN 16025 NO

Soffione doccia tondo con braccio da 350 mm.
Shower head, in round shape with shower arm 350 mm.

Riesenbrausekopf mit brausenarm 350 mm.

WN 16025 NO Ø mm.

NO 250

WN 41 NO

Monocomando incasso doccia con deviatore a 2 uscite.

Single lever for built-in shower with diverter with 2 outputs.

Einhebelmischbatterie für Dusche zum Einbau mit Umschaltventil.

WN 41 NO

NO

WN 99 NO

Presa acqua cilindrica in ottone con supporto. Completa di flessibile satilux e doccetta in ABS.

Round water supply with support.

With luxury flexible and shower.

WN 99 NO

NO



WINTER





CR

NI

WN 10

Monocomando vasca
Single lever bath mixer without/with shower kit
Einhebelmischbatterie für Wanne ohne/mit kit
Handbrause

WN 10 SD - senza kit doccia

CR
NI

WN 10 DXC - con kit doccia

CR
NI



ø 35 mm

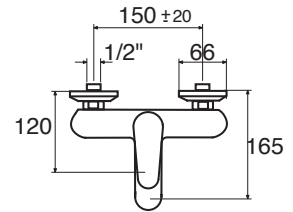

WN 20

Monocomando lavabo con scarico pop-up
Single lever basin mixer with pop-up waste
Einhebelmischbatterie für Waschbecken mit
Ablaufventil pop-up

WN 20

CR
NI



ø 35 mm

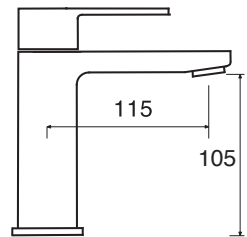

WN 21

Monocomando lavabo alto con scarico pop-up
Single lever high basin mixer with pop-up waste
Hohe Einhebelmischbatterie für Waschbecken mit
Ablaufventil pop-up

WN 21

CR
NI



ø 35 mm

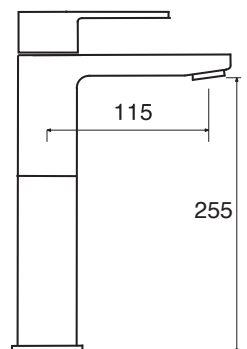

WN 30

Monocomando bidet con scarico pop-up
 Single lever bidet mixer with pop-up waste
 Einhebelmischbatterie für Bidet mit Ablaufventil pop-up

WN 30

CR

NI

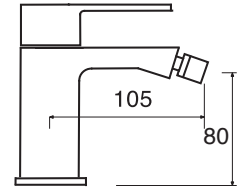

WN 40

Monocomando incasso doccia
 Single lever built-in shower mixer
 Einhebelmischbatterie für Dusche zum Einbau

WN 40

CR

NI

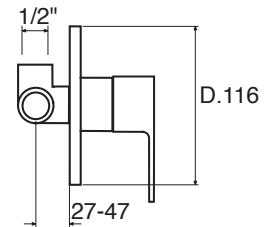

WN 41

Monocomando incasso doccia con deviatore a 2 uscite
 Single lever for built-in shower with diverter with 2 outputs
 Einhebelmischbatterie für Dusche zum Einbau mit Umschaltventil

WN 41

CR

NI

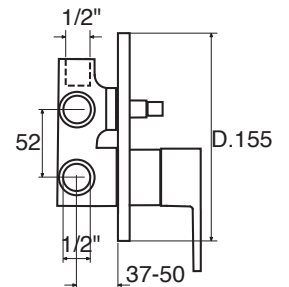

WN 50

Monocomando esterno doccia
 Single lever exterior shower without/with shower kit
 Einhebelmischbatterie für Dusche ohne/mit kit Handbrause

WN 50 SD - senza kit doccia

CR

NI

WN 50 DC - con kit doccia

CR

NI

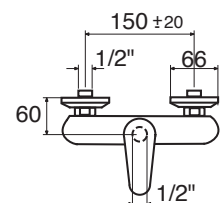



CR NO BO NI BR RA

WN 60 CP 20

Monocomandoavello a parete
Single lever wall sink mixer
Einhebelmischer wandspültischbatterie

WN 60 CP 20

CR
NI

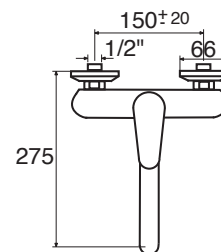

WN 70 CAO

Monocomando cucina canna alta
One-hole sink mixer, high spout
Küchen-Einhebelmischbatterie mit hohem Auslauf

WN 70 CAO

CR
NI

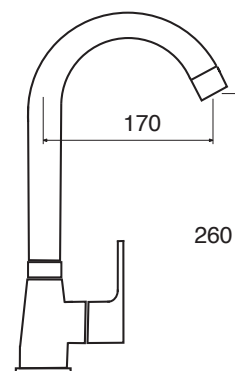

WN 22

Monocomando lavabo a colonna con scarico click clack
Single lever basin mixer with click clack waste
Einhebelmischbatterie für Waschbecken mit Ablaufventil click clack

WN 22

CR
NO - BO
NI - BR - RA

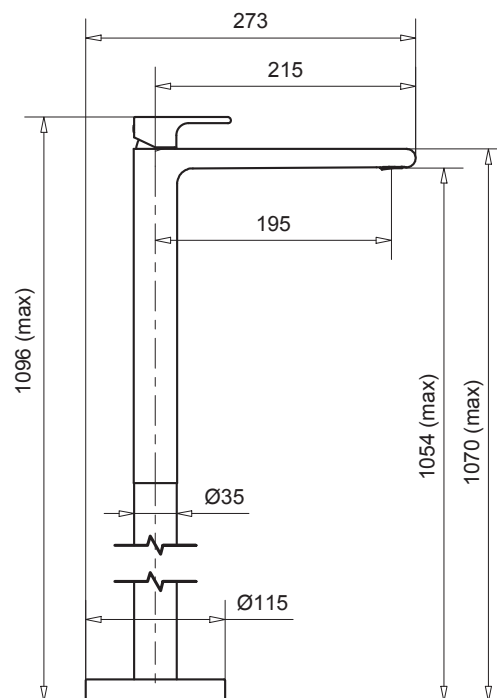

PARIS 2



PR2 10

Monocomando vasca
Single lever bath mixer without/with shower kit
Einhebelmischbatterie für Wanne ohne/mit kit
Handbrause

PR2 10 SD - senza kit doccia

CR

PR2 10 DXC - con kit doccia

CR

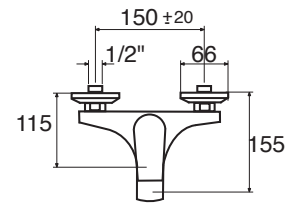

PR2 20

Monocomando lavabo con scarico pop-up
Single lever basin mixer with pop-up waste
Einhebelmischbatterie für Waschbecken mit
Ablaufventil pop-up

PR2 20

CR

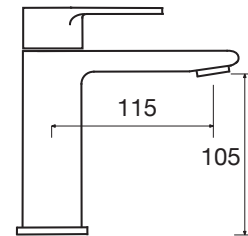

PR2 21

Monocomando lavabo alto con scarico pop-up
Single lever high basin mixer with pop-up waste
Hohe Einhebelmischbatterie für Waschbecken mit
Ablaufventil pop-up

PR2 21

CR

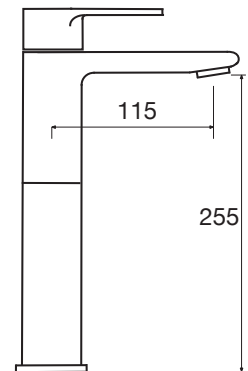

PR2 30

Monocomando bidet con scarico pop-up
Single lever bidet mixer with pop-up waste
Einhebelmischbatterie für Bidet mit Ablaufventil
pop-up

PR2 30

CR

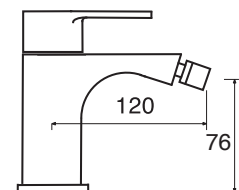

PR2 40

Monocomando incasso doccia
 Single lever built-in shower mixer
 Einhebelmischbatterie für Dusche zum Einbau

PR2 40

CR

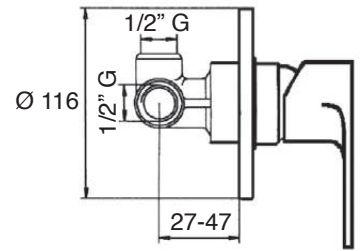

PR2 41

Monocomando incasso doccia con deviatore a 2 uscite
 Single lever for built-in shower with diverter with 2 outputs
 Einhebelmischbatterie für Dusche zum Einbau mit Umschaltventil

PR2 41

CR

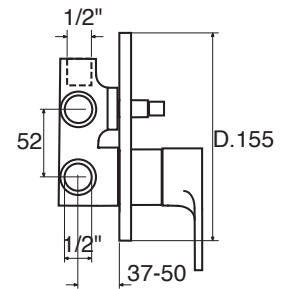

PR2 50 V

Monocomando esterno doccia
 Single lever exterior shower without/with shower kit
 Einhebelmischbatterie für Dusche ohne/mit kit Handbrause

PR2 50 V SD - senza kit doccia

CR

PR2 50 V DC - con kit doccia

CR

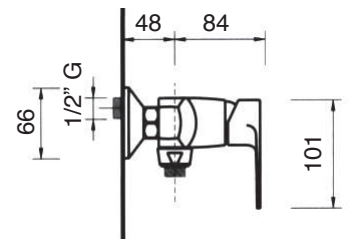

SPRING



SP 10

Monocomando vasca
Single lever bath mixer without/with shower kit
Einhebelmischbatterie für Wanne ohne/mit kit
Handbrause

SP 10 SD - senza kit doccia

CR

SP 10 DXC - con kit doccia

CR



ø 35 mm

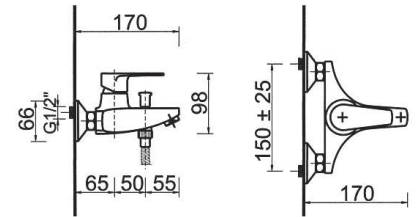

SP 20

Monocomando lavabo con scarico pop-up
Single lever basin mixer with pop-up waste
Einhebelmischbatterie für Waschbecken mit
Ablaufventil pop-up

SP 20

CR



ø 35 mm

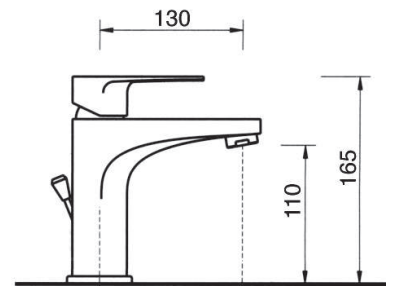

SP 21

Monocomando lavabo alto con scarico pop-up
Single lever high basin mixer with pop-up waste
Hohe Einhebelmischbatterie für Waschbecken mit
Ablaufventil pop-up

SP 21

CR



ø 35 mm

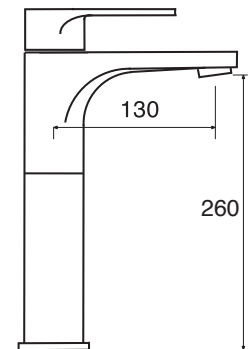

SP 30

Monocomando bidet con scarico pop-up
Single lever bidet mixer with pop-up waste
Einhebelmischbatterie für Bidet mit Ablaufventil
pop-up

SP 30

CR



ø 35 mm

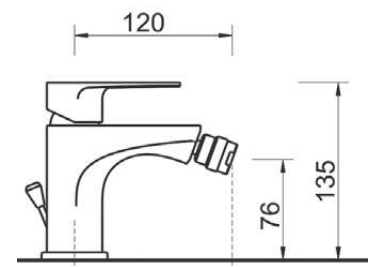

SP 40

Monocomando incasso doccia
 Single lever built-in shower mixer
 Einhebelmischbatterie für Dusche zum Einbau

SP 40

CR

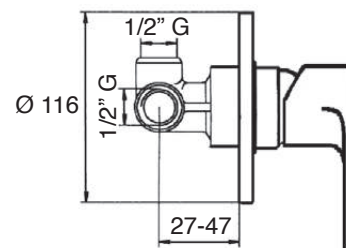

SP 41

Monocomando incasso doccia con deviatore a 2 uscite
 Single lever for built-in shower with diverter with 2 outputs
 Einhebelmischbatterie für Dusche zum Einbau mit Umschaltventil

SP 41

CR

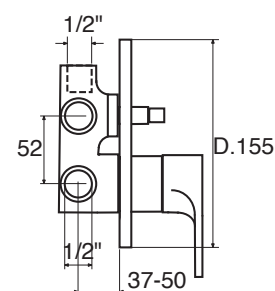

SP 50 V

Monocomando esterno doccia
 Single lever exterior shower without/with shower kit
 Einhebelmischbatterie für Dusche ohne/mit kit Handbrause

SP 50 V SD - senza kit doccia

CR

SP 50 V DC - con kit doccia

CR

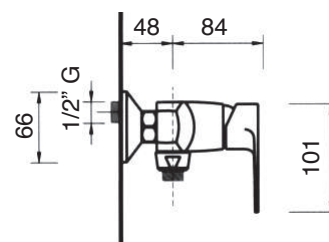

SP 60 CP 20

Monocomando lavello a parete
 Single lever wall sink mixer
 Einhebelmischer wandspültischbatterie

SP 60 CP 20

CR

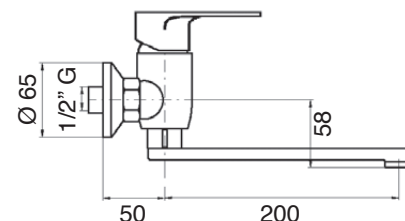

SUMMMER



SR 10

Monocomando vasca
Single lever bath mixer without/with shower kit
Einhebelmischbatterie für Wanne ohne/mit kit
Handbrause

SR 10 SD - senza kit doccia

CR

SR 10 DXC - con kit doccia

CR

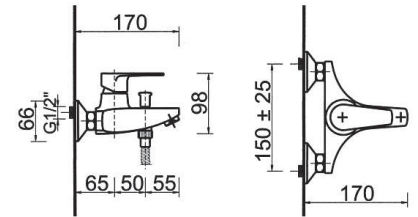

SR 20

Monocomando lavabo con scarico pop-up
Single lever basin mixer with pop-up waste
Einhebelmischbatterie für Waschbecken mit
Ablaufventil pop-up

SR 20

CR

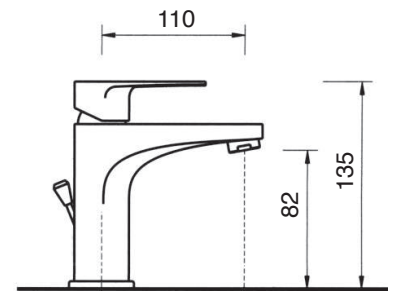

SR 21

Monocomando lavabo alto con scarico pop-up
Single lever high basin mixer with pop-up waste
Hohe Einhebelmischbatterie für Waschbecken mit
Ablaufventil pop-up

SR 21

CR

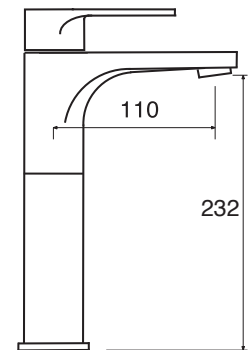

SR 30

Monocomando bidet con scarico pop-up
Single lever bidet mixer with pop-up waste
Einhebelmischbatterie für Bidet mit Ablaufventil
pop-up

SR 30

CR

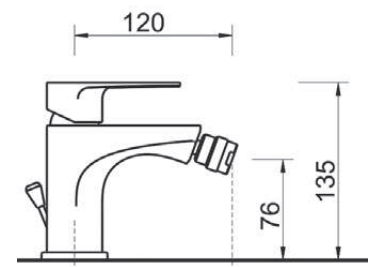

SR 40

Monocomando incasso doccia
 Single lever built-in shower mixer
 Einhebelmischbatterie für Dusche zum Einbau

SR 40

CR

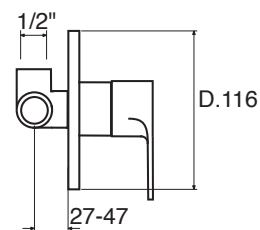

SR 41

Monocomando incasso doccia con deviatore a 2 uscite
 Single lever for built-in shower with diverter with 2 outputs
 Einhebelmischbatterie für Dusche zum Einbau mit Umschaltventil

SR 41

CR

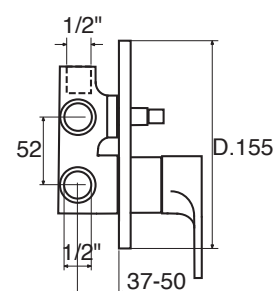

SR 50 V

Monocomando esterno doccia
 Single lever exterior shower without/with shower kit
 Einhebelmischbatterie für Dusche ohne/mit kit Handbrause

SR 50 V SD - senza kit doccia

CR

SR 50 V DC - con kit doccia

CR

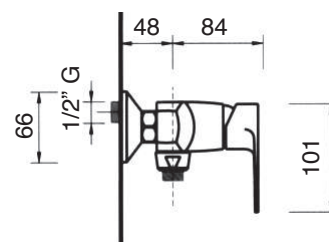

SR 60 CP 20

Monocomando lavello a parete
 Single lever wall sink mixer
 Einhebelmischer wandspültischbatterie

SR 60 CP 20

CR

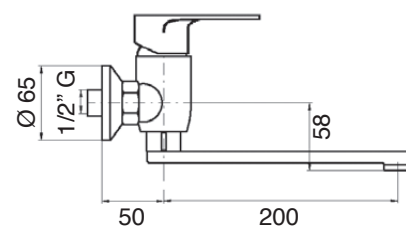

SR 13

Coppia supporti bordo vasca 3/4"
Pair of supports on tub edge 3/4"
Paar von Haltern für den Badewannenrand 3/4"

SR 13

CR

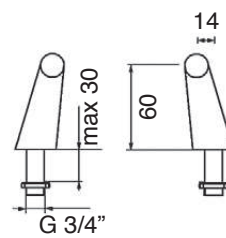
**SR 19**

Coppia colonne da terra per vasca esterna
Pair of columns for bathtub group
Standrohrpaar für freistehende
Badewanne, 3/4"-Konusaufnahme

SR 19

CR

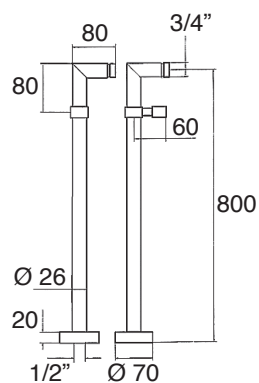
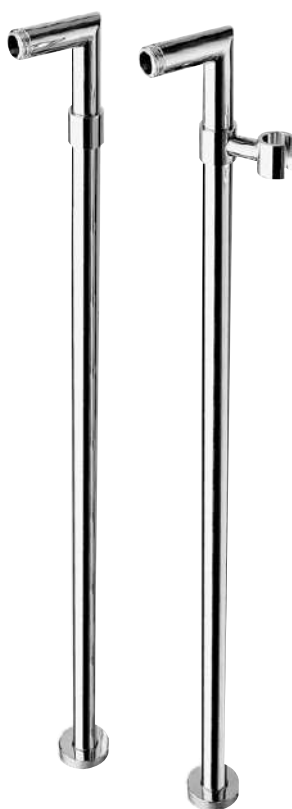

ANYA





CR BR RA NI GLD CPR GNM OR

AN 10

Monocomando vasca

Single lever bath mixer without/with shower kit

Einhebelmischbatterie für Wanne ohne/mit kit Handbrause

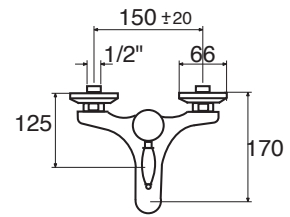

AN 10 SD - senza kit doccia

CR

BR - RA - NI

GLD - CPR - GNM

OR

AN 10 DXC - con kit doccia

CR

BR - RA - NI

GLD - CPR - GNM

OR

AN 20

Monocomando lavabo con scarico pop-up

Single lever basin mixer with pop-up waste

Einhebelmischbatterie für Waschbecken mit Ablaufventil pop-up

AN 20

CR

BR - RA - NI

GLD - CPR - GNM

OR

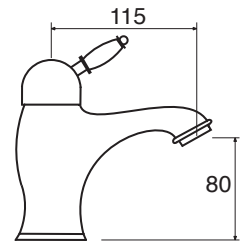

AN 25 BA

Monoforo lavabo bocca antica con scarico click-clack

Single hole wash-basin mixer, antique spout with click-clack waste

Waschtisch-sinlochbatterie, antiker Auslauf mit Ablaufventil click-clack

AN 25 BA

CR

BR - RA - NI

GLD - CPR - GNM

OR

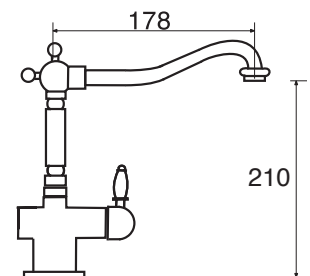

AN 30

Monocomando bidet con scarico pop-up

Single lever bidet mixer with pop-up waste

Einhebelmischbatterie für Bidet mit Ablaufventil pop-up

AN 30

CR

BR - RA - NI

GLD - CPR - GNM

OR

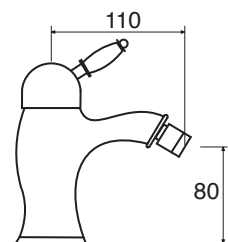

AN 35 BA

Monoforo bidet bocca antica con scarico click-clack
 Hone hole bidet mixer high spout with click-clack waste
 Bidet-einlochbatterie mit Ablaufventil click-clack

AN 35 BA

CR
 BR - RA - NI
 GLD - CPR - GNM
 OR

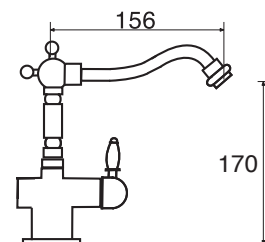

AN 40

Monocomando incasso doccia
 Single lever built-in shower mixer
 Einhebelmischbatterie für Dusche zum Einbau

AN 40

CR
 BR - RA - NI
 GLD - CPR - GNM
 OR

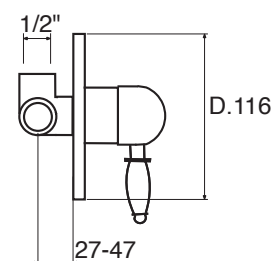

AN 41

Monocomando incasso doccia con deviatore a 2 uscite
 Single lever for built-in shower with diverter with 2 outputs
 Einhebelmischbatterie für Dusche zum Einbau mit Umschaltventil

AN 41

CR
 BR - RA - NI
 GLD - CPR - GNM
 OR

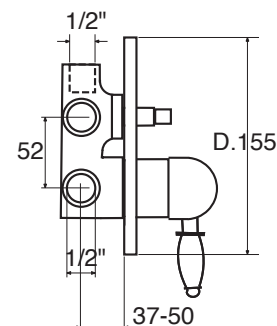

AN 50

Monocomando esterno doccia
 Single lever exterior shower without/with shower kit
 Einhebelmischbatterie für Dusche ohne/mit kit Handbrause



AN 50 SD - senza kit doccia

CR
 BR - RA - NI
 GLD - CPR - GNM
 OR

AN 50 DC - con kit doccia

CR
 BR - RA - NI
 GLD - CPR - GNM
 OR

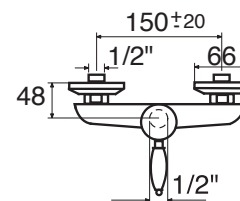



CR BR RA NI GLD CPR GNM OR

AN 60 CP 20

Monocomando lavello a parete
Single lever wall sink mixer
Einhebelmischer wandspültischbatterie

AN 60 CP 20

CR
BR - RA - NI
OR



Ø 40 mm

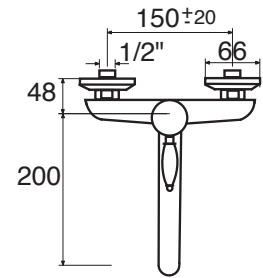

AN 19

Coppia colonne da terra per vasca esterna
Pair of columns for bathtub group
Standrohrpaar für freistehende
Badewanne, 3/4"-Konusaufnahme

AN 19

CR
BR - RA - NI
GLD - CPR - GNM
OR

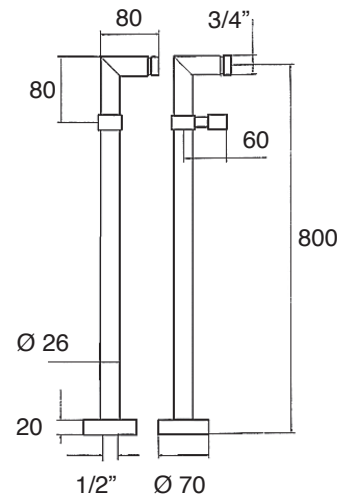
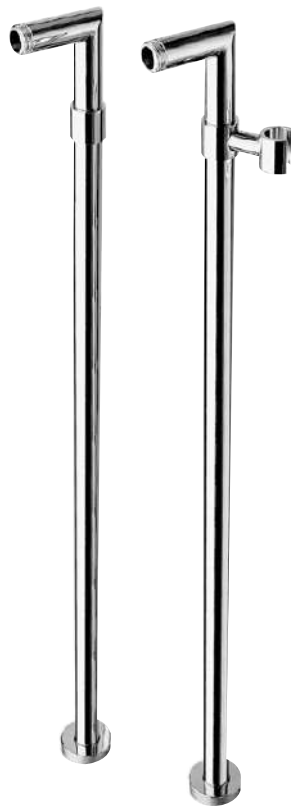

MANIGLIA SWAROVSKI

Swarovski Handle
Swarovski Griff

20537ANSW

CR
BR - RA - NI
GLD - CPR - GNM
OR



TORNADO





CR BR RA NI GLD CPR GNM OR

TR 10

Monocomando vasca

Single lever bath mixer without/with shower kit

Einhebelmischbatterie für Wanne ohne/mit kit Handbrause



TR 10 SD - senza kit doccia

CR

BR - RA - NI

GLD - CPR - GNM

OR

TR 10 DXC - con kit doccia

CR

BR - RA - NI

GLD - CPR - GNM

OR

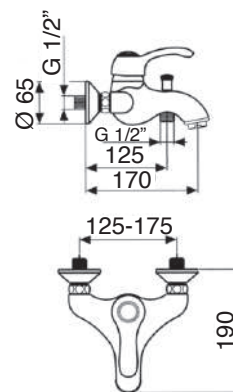

TR 20

Monocomando lavabo con scarico pop-up

Single lever basin mixer with pop-up waste

Einhebelmischbatterie für Waschbecken mit Ablaufventil pop-up

TR 20

CR

BR - RA - NI

GLD - CPR - GNM

OR

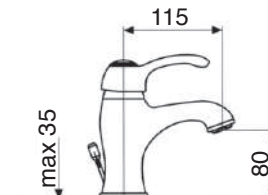

TR 30

Monocomando bidet con scarico pop-up

Single lever bidet mixer with pop-up waste

Einhebelmischbatterie für Bidet mit Ablaufventil pop-up

TR 30

CR

BR - RA - NI

GLD - CPR - GNM

OR

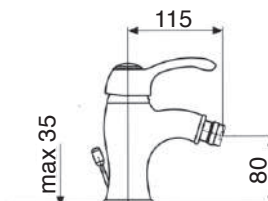

TR 40

Monocomando incasso doccia

Single lever built-in shower mixer

Einhebelmischbatterie für Dusche zum Einbau

TR 40

CR

BR - RA - NI

GLD - CPR - GNM

OR

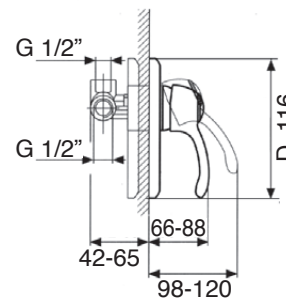

TR 41

Monocomando incasso doccia con deviatore a 2 uscite
Single lever for built-in shower with diverter with 2 outputs
Einhebelmischbatterie für Dusche zum Einbau mit Umschaltventil

TR 41

CR
 BR - RA - NI
 GLD - CPR - GNM
 OR

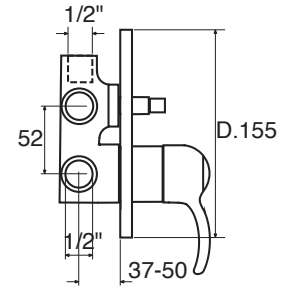

TR 50

Monocomando esterno doccia
Single lever exterior shower without/with shower kit
Einhebelmischbatterie für Dusche ohne/mit kit Handbrause

TR 50 SD - senza kit doccia

CR
 BR - RA - NI
 GLD - CPR - GNM
 OR

TR 50 DC - con kit doccia

CR
 BR - RA - NI
 GLD - CPR - GNM
 OR

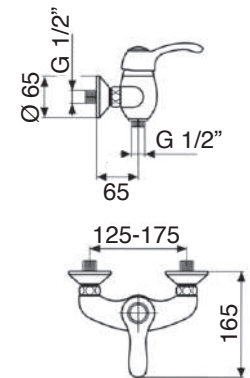

TR 60 CP 20

Monocomando lavello a parete
Single lever wall sink mixer
Einhebelmischer wandspültischbatterie

TR 60 CP 20

CR
 BR - RA - NI
 OR

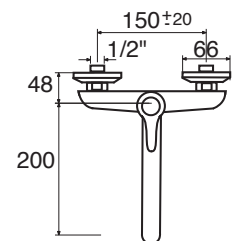

TR 19

Coppia colonne da terra per vasca esterna
Pair of columns for bathtub group
Standrohrpaar für freistehende Badewanne, 3/4"-Konusaufnahme

TR 19

CR
 BR - RA - NI
 GLD - CPR - GNM
 OR

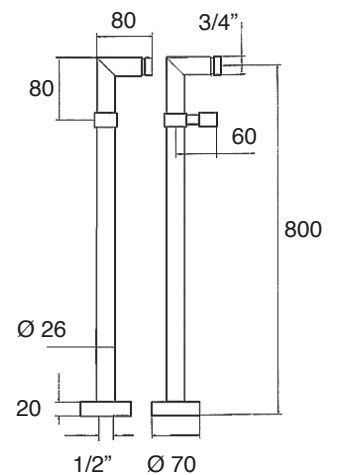
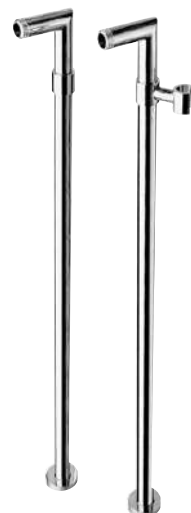

START



ST 10 DC

Monocomando vasca con kit doccia
Single lever bath mixer with shower kit
Einhebelmischbatterie für Wanne mit kit Handbrause

ST 10 DC

CR

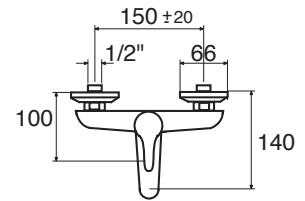

ST 20

Monocomando lavabo con scarico pop-up
Single lever basin mixer with pop-up waste
Einhebelmischbatterie für Waschbecken mit Ablaufventil pop-up

ST 20

CR

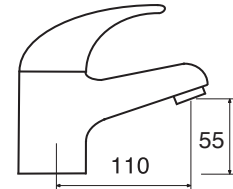

ST 30

Monocomando bidet con scarico pop-up
Single lever bidet mixer with pop-up waste
Einhebelmischbatterie für Bidet mit Ablaufventil pop-up

ST 30

CR

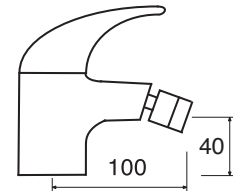

ST 40

Monocomando incasso doccia
Single lever built-in shower mixer
Einhebelmischbatterie für Dusche zum Einbau

ST 40

CR

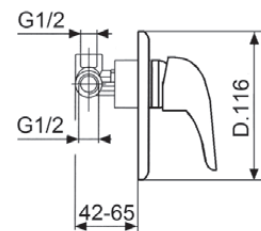

ST 41

Monocomando incasso doccia con deviatore a 2 uscite
 Single lever for built-in shower with diverter with 2 outputs
 Einhebelmischbatterie für Dusche zum Einbau mit Umschaltventil

ST 41

CR

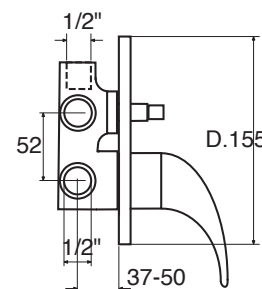

ST 50 DC

Monocomando esterno doccia con kit doccia
 Single lever exterior shower with shower kit
 Einhebelmischbatterie für Dusche mit kit Handbrause

ST 50 DC

CR

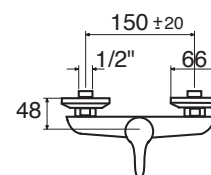

ST 60 CP 20

Monocomando lavello a parete
 Single lever wall sink mixer
 Einhebelmischer wandsplültischbatterie

ST 60 CP 20

CR

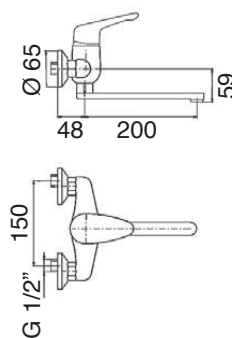

ST 70 CAC

Monocomando cucina canna alta curva
 Wall mounted sink mixer high spout
 Küchen-Einhebelmischbatterie mit hohem,

ST 70 CAC

CR

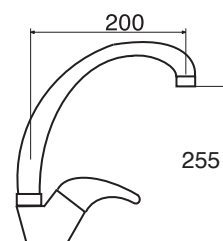

ST 70 CB

Monocomando cucina
Single lever sink mixer
Küchen-Einhebelmischbatterie

ST 70 CB

CR

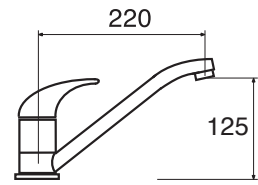

KING



T



CR BR RA NI OR

KN 10

Gruppo vasca esterno
Bath mixer without/with brass duplex shower kit
Badebatterie ohne/mit kit brausegarnitur duplex

KN 10 SD - senza kit doccia

CR
 BR - RA - NI
 OR

KN 10 DXO - con kit doccia

CR
 BR - RA - NI
 OR



90° - CERAMICO

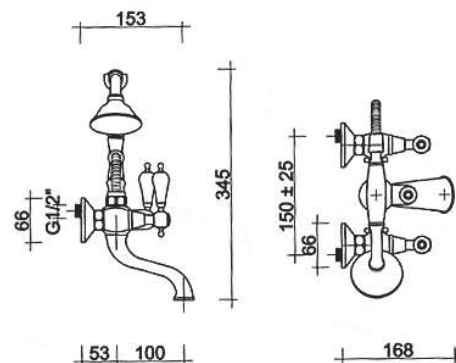

KN 20 BF

Batteria per lavabo a tre fori bocca fusa
3-holes wash-basin mixer
3-loch waschtischbatterie

KN 20 BF

CR
 BR - RA - NI
 OR



90° - CERAMICO

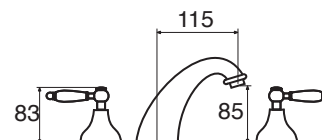

KN 20 BA

Batteria per lavabo a tre fori, bocca antica
3-holes wash-basin mixer cast, antique spout
3-loch waschtischbatterie, antiker Auslauf

KN 20 BA

CR
 BR - RA - NI
 OR



90° - CERAMICO

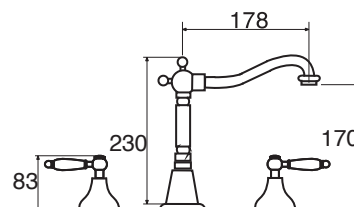

KN 25 BA

Monoforo lavabo bocca antica
Single hole wash-basin mixer, antique spout
Waschtisch-sinlochbatterie, antiker Auslauf

KN 25 BA

CR
 BR - RA - NI
 OR



90° - CERAMICO

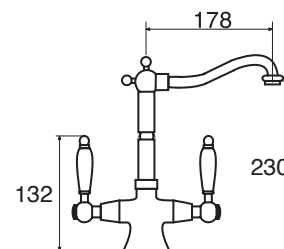

KN 26

Batteria lavabo incasso senza scarico
3-holes wash-basin mixer without drain
3-loch waschtischbatterie ohne Ablauf

KN 26

CR
 BR - RA - NI
 OR



90° - CERAMICO

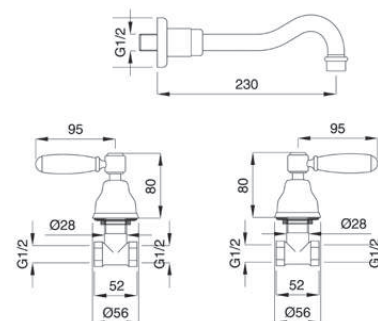

KN 30

Combinazione bidet
Bidet set
Combinaison bidet

KN 30

CR
 BR - RA - NI
 OR



90° - CERAMICO

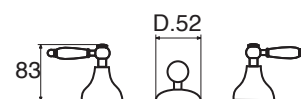

KN 30 BF

Batteria per bidet a tre fori, bocca fusa
3-holes bidet mixer casted spout
3-loch bidetbatterie

KN 30 BF

CR
 BR - RA - NI
 OR



90° - CERAMICO

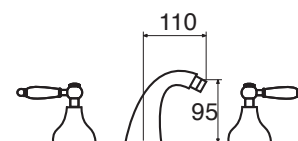

KN 30 BA

Batteria per bidet a tre fori, bocca antica
3-holes bidet mixer cast, antique spout
3-loch bidetbatterie, antiker Auslauf

KN 30 BA

CR
 BR - RA - NI
 OR



90° - CERAMICO

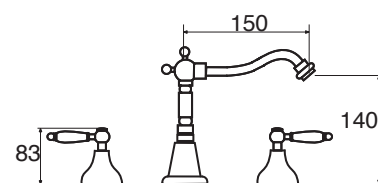

KN 35 BA

Monoforo bidet bocca antica
Hone hole bidet mixer high spout, antique spout
Bidet-einlochbatterie, antiker Auslauf

KN 35 BA

CR
 BR - RA - NI
 OR



90° - CERAMICO

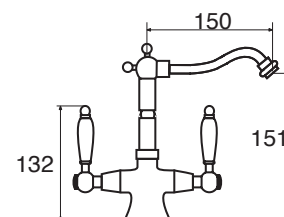



CR BR RA NI OR

KN 40

Rubinetto incasso 1/2"
Straight valve 1/2"
Robinet encastré 1/2"

KN 40

CR
BR - RA - NI
OR



90° - CERAMICO

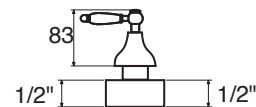

KN 50

Gruppo doccia esterno
Shower mixer without/with shower set
Groupe douche extérieur ohne/mit douche laiton

KN 50 SD - senza kit doccia

CR
BR - RA - NI
OR

KN 50 DO - con kit doccia

CR
BR - RA - NI
OR



90° - CERAMICO

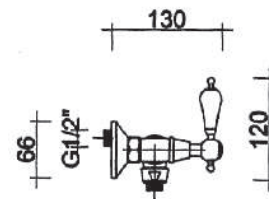

51

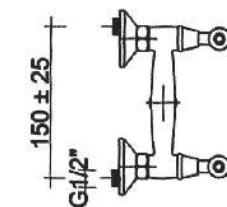

130

KN 60 BA

Gruppo lavello parete, bocca antica
Wall sink mixer, antique spout
Spülbeckengruppe für die Wand, antiker Auslauf

KN 60 BA

CR
BR - RA - NI
OR



90° - CERAMICO

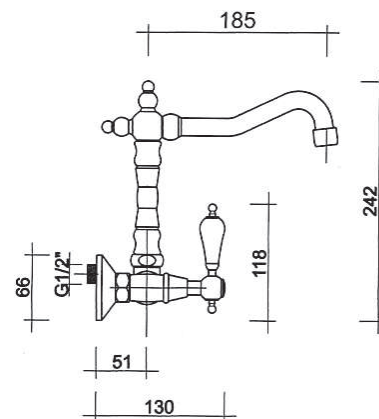

MANIGLIA SWAROVSKI

Swarovski Handle
Swarovski Griff

20801SW

CR
BR - RA - NI
OR



20801SW

20802SW

CR
BR - RA - NI
OR



20802SW



KISS





CR BR RA NI OR

KS 10

Gruppo vasca esterno
Bath mixer without/with brass duplex shower kit
Badebatterie ohne/mit kit brausegarnitur duplex

KS 10 SD - senza kit doccia

CR
BR - RA - NI
OR

KS 10 DXO - con kit doccia

CR
BR - RA - NI
OR

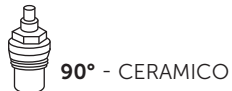

90° - CERAMICO

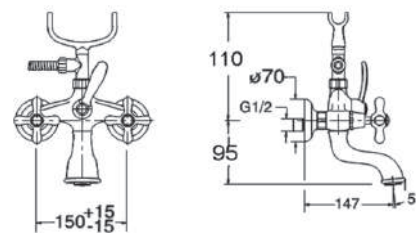

KS 20 BF

Batteria per lavabo a tre fori bocca fusa
3-holes wash-basin mixer
3-loch waschtischbatterie

KS 20 BF

CR
BR - RA - NI
OR

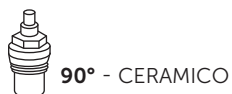

90° - CERAMICO

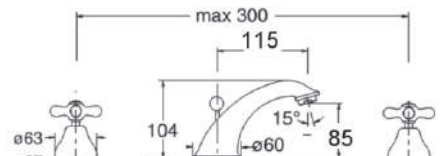

KS 20 CAO

Batteria per lavabo a tre fori, bocca alta
3-holes wash-basin mixer cast
3-loch waschtischbatterie

KS 20 CAO

CR
BR - RA - NI
OR

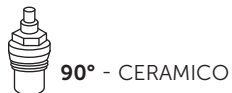

90° - CERAMICO

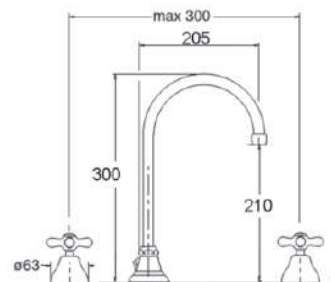

KS 20 BA

Batteria per lavabo a tre fori, bocca antica
3-holes wash-basin mixer cast, antique spout
3-loch waschtischbatterie, antiker Auslauf

KS 20 BA

CR
BR - RA - NI
OR

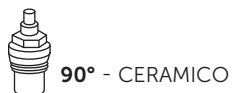

90° - CERAMICO

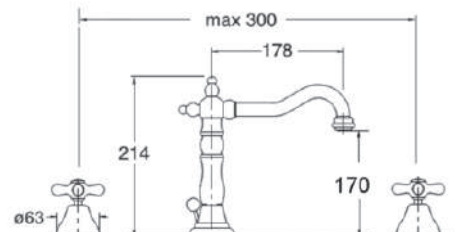

KS 25 BF

Monoforo monoblocco per lavabo
Monobloc wash-basin mixer
Waschtisch-sinlochbatterie

KS 25 BF

CR
 BR - RA - NI
 OR



90° - CERAMICO

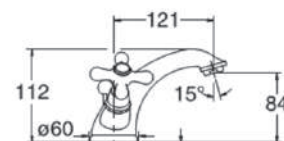

KS 25 CAO

Monoforo lavabo bocca alta
Single hole wash-basin mixer
Waschtisch-sinlochbatterie

KS 25 CAO

CR
 BR - RA - NI
 OR



90° - CERAMICO

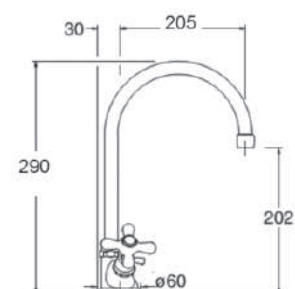

KS 25 BA

Monoforo lavabo bocca antica
Single hole wash-basin mixer, antique spout
Waschtisch-sinlochbatterie, antiker Auslauf

KS 25 BA

CR
 BR - RA - NI
 OR



90° - CERAMICO

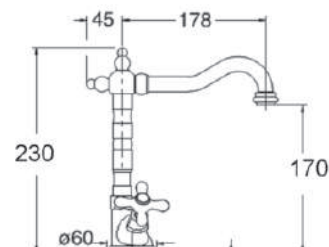

KS 26

Batteria lavabo incasso senza scarico
3-holes wash-basin mixer without drain
3-loch waschtischbatterie ohne Ablauf

KS 26

CR
 BR - RA - NI
 OR



90° - CERAMICO

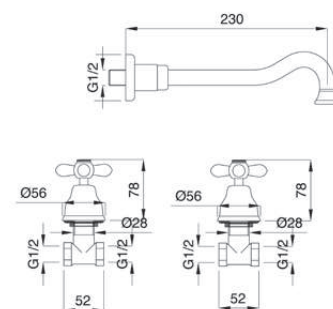



CR BR RA NI OR

KS 30

Combinazione bidet
Bidet set
Combinaison bidet

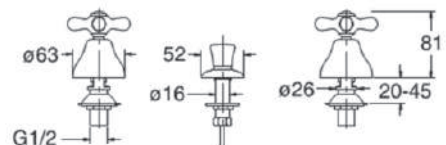

KS 30

CR
BR - RA - NI
OR

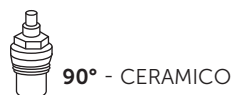

KS 30 BF

Batteria per bidet a tre fori, bocca fusa
3-holes bidet mixer casted spout
3-loch bidetbaterie

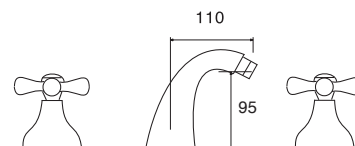

KS 30 BF

CR
BR - RA - NI
OR

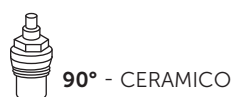

KS 30 BA

Batteria per bidet a tre fori, bocca antica
3-holes bidet mixer cast, antique spout
3-loch bidetbaterie, antiker Auslauf

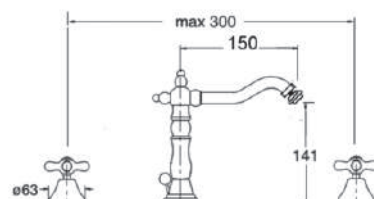

KS 30 BA

CR
BR - RA - NI
OR

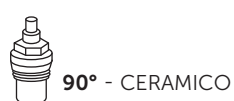

KS 35 BF

Monoforo monoblocco per bidet
Monobloc bidet mixer
Bidet-einlochbaterie

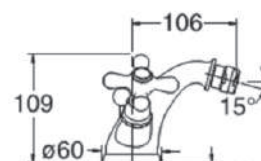

KS 35 BF

CR
BR - RA - NI
OR

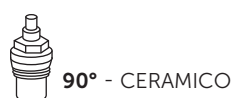

KS 35 BA

Monoforo bidet bocca antica
 Single hole bidet mixer, antique spout
 Waschtisch-sinlochbatterie, antiker Auslauf

KS 35 BA

CR
 BR - RA - NI
 OR



90° - CERAMICO

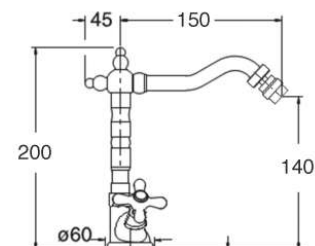

KS 40

Rubinetto incasso 1/2"
 Straight valve 1/2"
 Robinet encastrément 1/2"

KS 40

CR
 BR - RA - NI
 OR



90° - CERAMICO

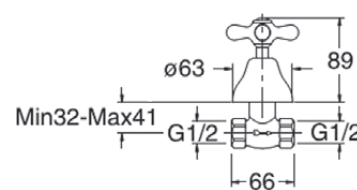

KS 50

Gruppo doccia esterno
 Shower mixer without/with shower set
 Groupe douche extérieur ohne/mit douche laiton

KS 50 SD - senza kit doccia

CR
 BR - RA - NI
 OR

KS 50 DO - con kit doccia

CR
 BR - RA - NI
 OR



90° - CERAMICO

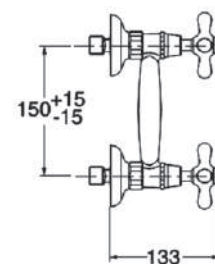
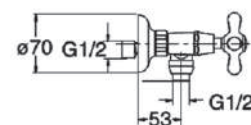

KS 60 CS 20

Gruppo lavello parete, canna inferiore cm. 20
 Wall sink mixer, inferior spout cm. 20
 Spülbeckengruppe für die Wand, unterer Auslauf, 20 cm

KS 60 CS 20

CR
 BR - RA - NI
 OR



90° - CERAMICO

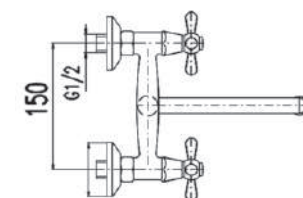
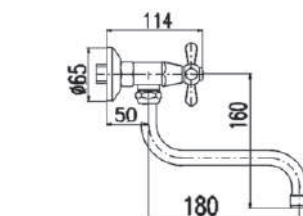



CR BR RA NI OR

KS 13

Coppia supporti bordo vasca 3/4"

Pair of supports on tub edge 3/4"

Paar von Haltern für den Badewannenrand 3/4"

KS 13

CR

BR - RA - NI

OR

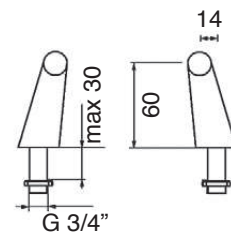

KS 19

Coppia colonne da terra per vasca esterna

Pair of columns for bathtub group

Standrohrpaar für freistehende Badewanne, 3/4"-Konusaufnahme

KS 19

CR

BR - RA - NI

OR

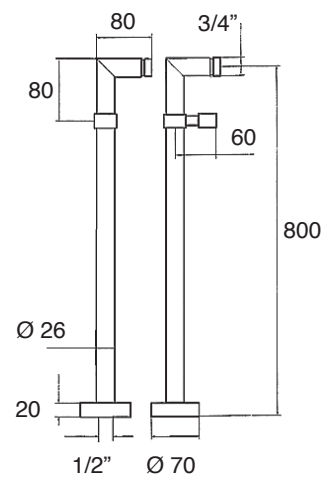
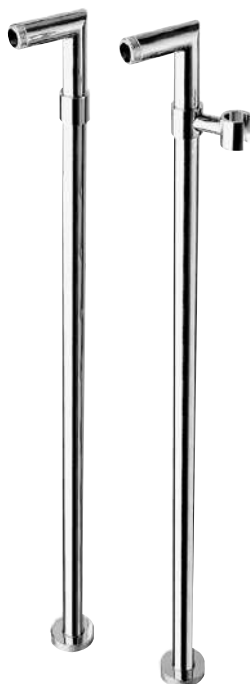

SIRIO





SI 11

Gruppo vasca esterno
Bath mixer without/with shower kit
Badebatterie ohne/mit brausegarnitur

SI 11 SD - senza kit doccia

- _____ CR
- _____ BO - NO
- _____ NI - BR - RA
- _____ GLD - CPR - GNM
- _____ OR

SI 11 DXC - con kit doccia

- _____ CR
- _____ BO - NO
- _____ NI - BR - RA
- _____ GLD - CPR - GNM
- _____ OR

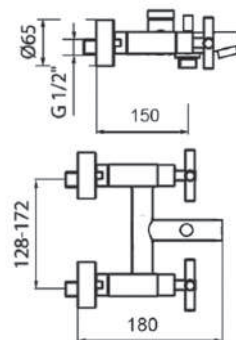

SI 20 CAO

Batteria per lavabo a tre fori, bocca alta
3-holes wash-basin mixer cast
3-loch waschtvschbatterie

SI 20 CAO

- _____ CR
- _____ BO - NO
- _____ NI - BR - RA
- _____ GLD - CPR - GNM
- _____ OR

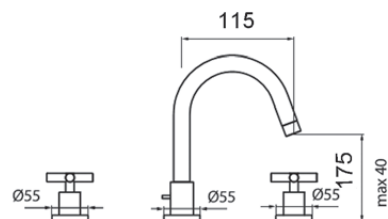
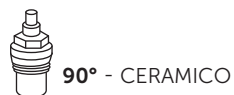

SI 25 BF

Monoforo monoblocco per lavabo
Monobloc wash-basin mixer
Waschtvsch-sinlochbatterie

SI 25 BF

- _____ CR
- _____ BO - NO
- _____ NI - BR - RA
- _____ GLD - CPR - GNM
- _____ OR

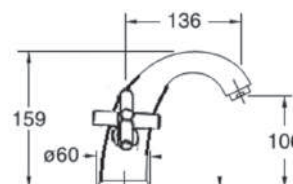
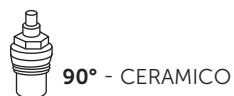

SI 25 CAO

Monoforo lavabo bocca alta
Single hole wash-basin mixer
Waschtisch-einlochbatterie

SI 25 CAO

CR
BO - NO
NI - BR - RA
GLD - CPR - GNM
OR



90° - CERAMICO

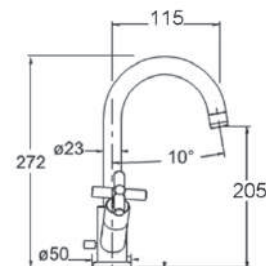

SI 26

Batteria lavabo incasso senza scarico
3-holes wash-basin mixer without drain
3-loch waschtischbatterie ohne Ablauf

SI 26

CR
BO - NO
NI - BR - RA
GLD - CPR - GNM
OR



90° - CERAMICO

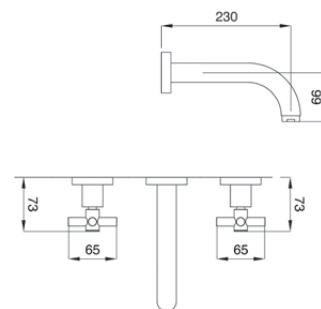

SI 30

Combinazione bidet
Bidet set
Combinaison bidet

SI 30

CR
BO - NO
NI - BR - RA
GLD - CPR - GNM
OR



90° - CERAMICO





SI 30 CAO

Batteria per bidet a 3 fori
3-hole bidet mixer cast
3-lock bidetbatterie

SI 30 CAO

- _____ CR
- _____ BO - NO
- _____ NI - BR - RA
- _____ GLD - CPR - GNM
- _____ OR

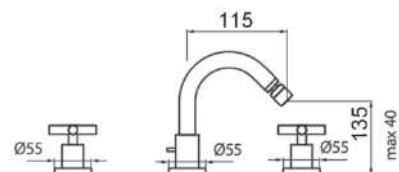

90° - CERAMICO

SI 35 BF

Monoforo monoblocco per bidet
Monobloc bidet mixer
Bidet-einlochbatterie

SI 35 BF

- _____ CR
- _____ BO - NO
- _____ NI - BR - RA
- _____ GLD - CPR - GNM
- _____ OR

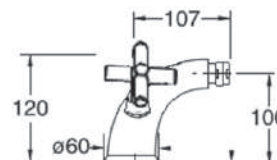

90° - CERAMICO

SI 35 CAO

Monoforo bidet
Hone hole bidet mixer high spout
Bidet-einlochbatterie

SI 35 CAO

- _____ CR
- _____ BO - NO
- _____ NI - BR - RA
- _____ GLD - CPR - GNM
- _____ OR

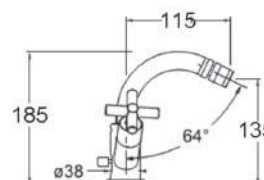

90° - CERAMICO

SI 40-12

Rubinetto incasso 1/2"
Straight valve 1/2"
Einbauarmatur 1/2"

SI 40-12

- _____ CR
- _____ BO - NO
- _____ NI - BR - RA
- _____ GLD - CPR - GNM
- _____ OR

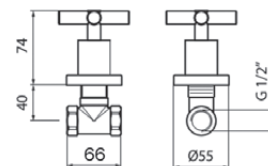

90° - CERAMICO



SI 46

Batteria doccia incasso con deviatore 2 uscite
3 Holes built-in diverter 2 outputs

SI 46

CR
 BO - NO
 NI - BR - RA
 GLD - CPR - GNM
 OR



90° - CERAMICO

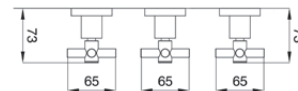

SI 50

Gruppo doccia esterno
Shower mixer without/with shower set
Groupe douche extérieur ohne/mit douche laiton

SI 50 SD - senza kit doccia

CR
 BO - NO
 NI - BR - RA
 GLD - CPR - GNM
 OR

SI 50 DC - con kit doccia

CR
 BO - NO
 NI - BR - RA
 GLD - CPR - GNM
 OR



90° - CERAMICO

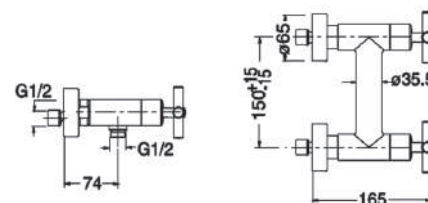

SI 60 CS 20

Gruppo lavello parete, canna inferiore cm. 20
Wall sink mixer, inferior spout cm. 20
Spülbeckengruppe für die Wand, unterer Auslauf, 20 cm

SI 60 CS 20

CR
 BO - NO
 NI - BR - RA
 GLD - CPR - GNM
 OR



90° - CERAMICO

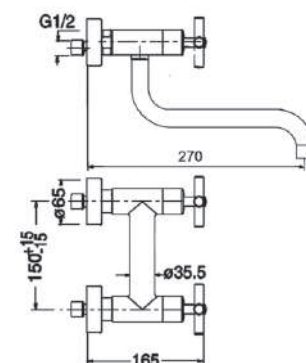

ATLANTIC



NEW



FINITURA MANIGLIA

Handle finishings

Per tutti gli articoli della serie Atlantic è disponibile la maniglia nelle seguenti finiture, in abbinamento al corpo nelle altre finiture, senza supplemento di prezzo.

Esempio: Corpo GLD + maniglia RED (foto sopra)



CR



RED



NO



BO



NI



GLD



CPR



GNM

AT 11

Gruppo vasca esterno
 Bath mixer without/with shower kit
 Badebatterie ohne/mit brausegarnitur

AT 11 SD - senza kit doccia

CR
 BO - NO
 NI - BR - RA
 GLD - CPR - GNM
 OR

AT 11 DXC - con kit doccia

CR
 BO - NO
 NI - BR - RA
 GLD - CPR - GNM
 OR

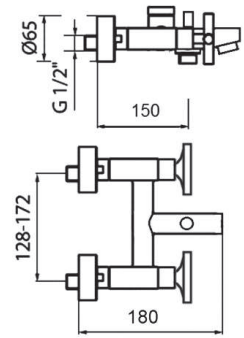

90° - CERAMICO

**AT 20 CAO**

Batteria per lavabo a tre fori, bocca alta
 3-holes wash-basin mixer cast
 3-loch waschtvschbatterie

AT 20 CAO

CR
 BO - NO
 NI - BR - RA
 GLD - CPR - GNM
 OR

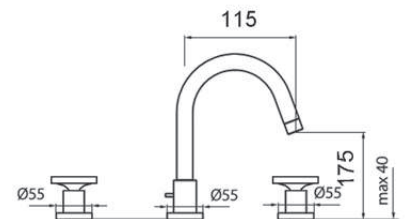

90° - CERAMICO

**AT 25 BF**

Monoforo monoblocco per lavabo
 Monobloc wash-basin mixer
 Waschtvsch-sinlochbatterie

AT 25 BF

CR
 BO - NO
 NI - BR - RA
 GLD - CPR - GNM
 OR



90° - CERAMICO

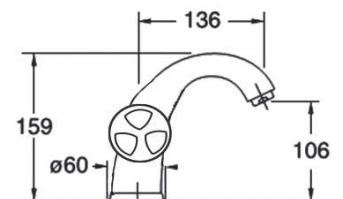



CR



NO



BO



NI



BR



RA



GLD



CPR



GNM



OR

NEW**AT 25 CAO**

Monoforo lavabo bocca alta
Single hole wash-basin mixer
Waschtisch-einlochbatterie

AT 25 CAO

CR

BO - NO

NI - BR - RA

GLD - CPR - GNM

OR

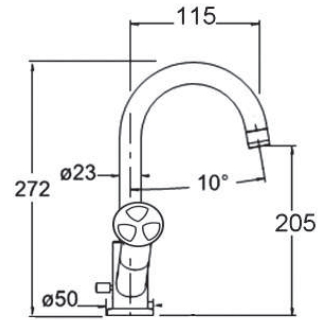

90° - CERAMICO

**AT 26**

Batteria lavabo incasso senza scarico
3-holes wash-basin mixer without drain
3-loch waschtischbatterie ohne Ablauf

AT 26

CR

BO - NO

NI - BR - RA

GLD - CPR - GNM

OR

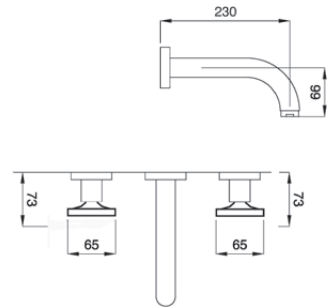

90° - CERAMICO

**AT 30**

Combinazione bidet
Bidet set
Combinaison bidet

AT 30

CR

BO - NO

NI - BR - RA

GLD - CPR - GNM

OR



90° - CERAMICO

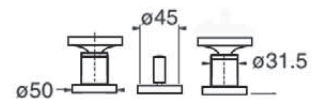

AT 30 CAO

Batteria per bidet a 3 fori
3-hole bidet mixer cast
3-lock bidetbatterie

AT 30 CAO

- _____ CR
- _____ BO - NO
- _____ NI - BR - RA
- _____ GLD - CPR - GNM
- _____ OR

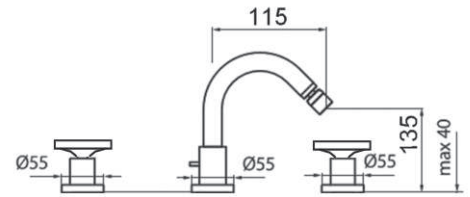
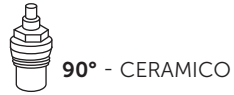

AT 35 BF

Monoforo monoblocco per bidet
Monobloc bidet mixer
Bidet-einlochbatterie

AT 35 BF

- _____ CR
- _____ BO - NO
- _____ NI - BR - RA
- _____ GLD - CPR - GNM
- _____ OR

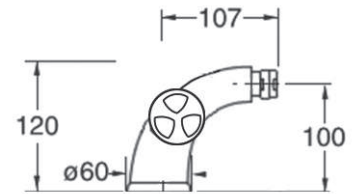
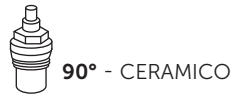

AT 35 CAO

Monoforo bidet
Hone hole bidet mixer high spout
Bidet-einlochbatterie

AT 35 CAO

- _____ CR
- _____ BO - NO
- _____ NI - BR - RA
- _____ GLD - CPR - GNM
- _____ OR

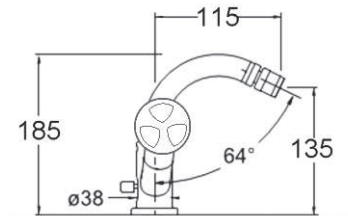
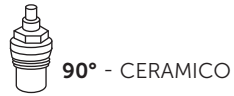

AT 40-12

Rubinetto incasso 1/2"
Straight valve 1/2"
Einbauarmatur 1/2"

AT 40-12

- _____ CR
- _____ BO - NO
- _____ NI - BR - RA
- _____ GLD - CPR - GNM
- _____ OR

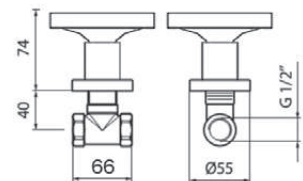
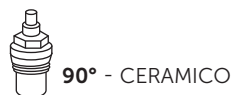



CR



NO



BO



NI



BR



RA



GLD



CPR



GNM



OR

NEW**AT 46**

Batteria doccia incasso con deviatore 2 uscite
3 Holes built-in diverter 2 outputs

AT 46

CR

BO - NO

NI - BR - RA

GLD - CPR - GNM

OR

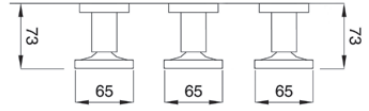

90° - CERAMICO

**AT 50**

Gruppo doccia esterno
Shower mixer without/with shower set
Groupe douche extérieur ohne/mit douche laiton

AT 50 SD - senza kit doccia

CR

BO - NO

NI - BR - RA

GLD - CPR - GNM

OR

AT 50 DC - con kit doccia

CR

BO - NO

NI - BR - RA

GLD - CPR - GNM

OR

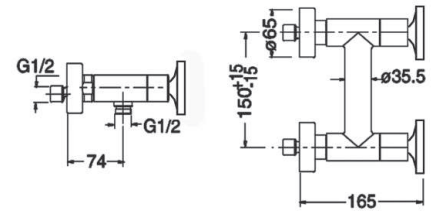

90° - CERAMICO

**AT 60 CS 20**

Gruppo lavello parete, canna inferiore cm. 20
Wall sink mixer, inferior spout cm. 20
Spülbeckengruppe für die Wand, unterer Auslauf, 20 cm

AT 60 CS 20

CR

BO - NO

NI - BR - RA

GLD - CPR - GNM

OR



90° - CERAMICO

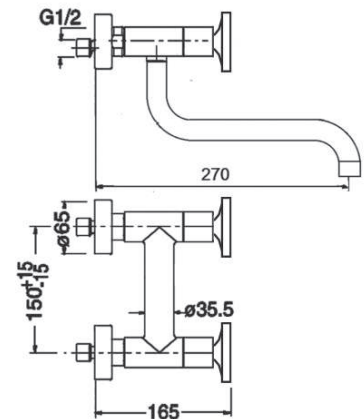

PACIFIC



NEW





PC 11

Gruppo vasca esterno
Bath mixer without/with shower kit
Badebatterie ohne/mit brausegarnitur

PC 11 SD - senza kit doccia

- _____ CR
- _____ BO - NO
- _____ NI - BR - RA
- _____ GLD - CPR - GNM
- _____ OR

PC 11 DXC - con kit doccia

- _____ CR
- _____ BO - NO
- _____ NI - BR - RA
- _____ GLD - CPR - GNM
- _____ OR

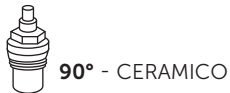
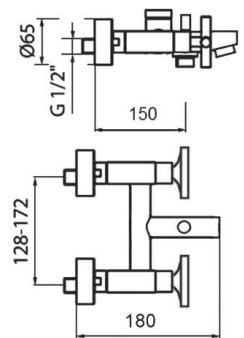

PC 20 CAO

Batteria per lavabo a tre fori, bocca alta
3-holes wash-basin mixer cast
3-loch waschtvschbatterie

PC 20 CAO

- _____ CR
- _____ BO - NO
- _____ NI - BR - RA
- _____ GLD - CPR - GNM
- _____ OR

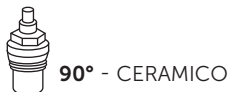
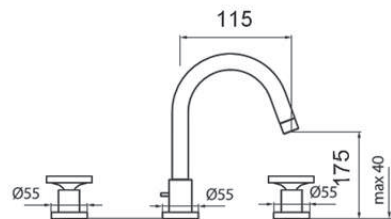

PC 25 BF

Monoforo monoblocco per lavabo
Monobloc wash-basin mixer
Waschtvsch-sinlochbatterie

PC 25 BF

- _____ CR
- _____ BO - NO
- _____ NI - BR - RA
- _____ GLD - CPR - GNM
- _____ OR

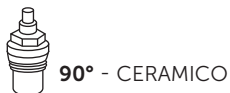
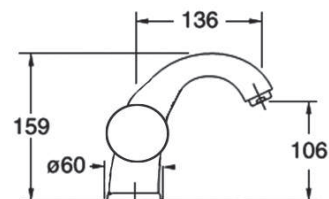

PC 25 CAO

Monoforo lavabo bocca alta
Single hole wash-basin mixer
Waschtvsch-einlochbatterie

PC 25 CAO

- CR
- BO - NO
- NI - BR - RA
- GLD - CPR - GNM

OR



90° - CERAMICO

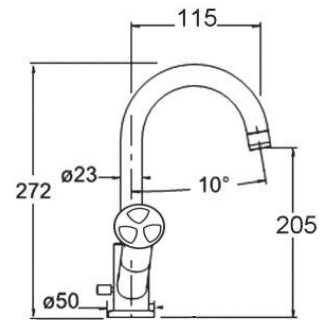

PC 26

Batteria lavabo incasso senza scarico
3-holes wash-basin mixer without drain
3-loch waschtischbatterie ohne Ablauf

PC 26

- CR
- BO - NO
- NI - BR - RA
- GLD - CPR - GNM

OR



90° - CERAMICO

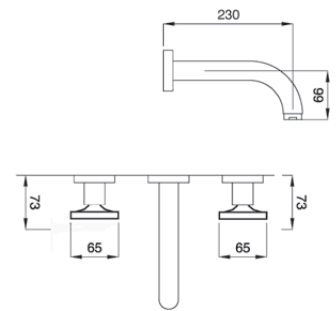

PC 30

Combinazione bidet
Bidet set
Combinaison bidet

PC 30

- CR
- BO - NO
- NI - BR - RA
- GLD - CPR - GNM

OR



90° - CERAMICO

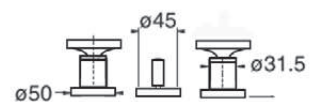



PC 30 CAO

Batteria per bidet a 3 fori
3-hole bidet mixer cast
3-lock bidetbatterie

PC 30 CAO

- _____ CR
- _____ BO - NO
- _____ NI - BR - RA
- _____ GLD - CPR - GNM
- _____ OR

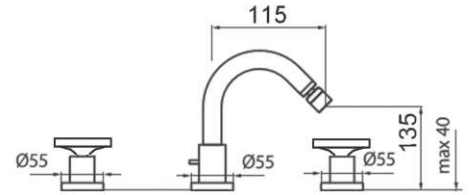
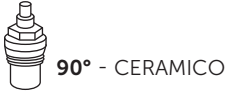

PC 35 BF

Monoforo monoblocco per bidet
Monobloc bidet mixer
Bidet-einlochbatterie

PC 35 BF

- _____ CR
- _____ BO - NO
- _____ NI - BR - RA
- _____ GLD - CPR - GNM
- _____ OR

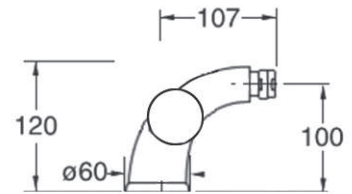
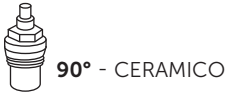

PC 35 CAO

Monoforo bidet
Hone hole bidet mixer high spout
Bidet-einlochbatterie

PC 35 CAO

- _____ CR
- _____ BO - NO
- _____ NI - BR - RA
- _____ GLD - CPR - GNM
- _____ OR

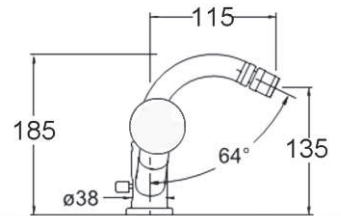
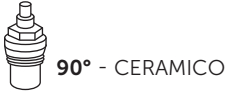

PC 40-12

Rubinetto incasso 1/2"
Straight valve 1/2"
Einbauarmatur 1/2"

PC 40-12

- _____ CR
- _____ BO - NO
- _____ NI - BR - RA
- _____ GLD - CPR - GNM
- _____ OR

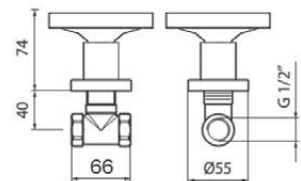
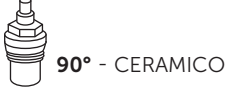

PC 46

Batteria doccia incasso con deviatore 2 uscite
3 Holes built-in diverter 2 outputs

PC 46

- CR
- BO - NO
- NI - BR - RA
- GLD - CPR - GNM
- OR

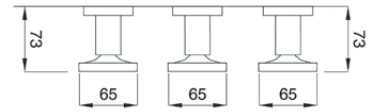
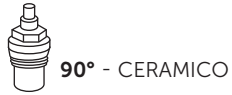

PC 50

Gruppo doccia esterno
Shower mixer without/with shower set
Groupe douche extérieur ohne/mit douche laiton

PC 50 SD - senza kit doccia

- CR
- BO - NO
- NI - BR - RA
- GLD - CPR - GNM
- OR

PC 50 DC - con kit doccia

- CR
- BO - NO
- NI - BR - RA
- GLD - CPR - GNM
- OR

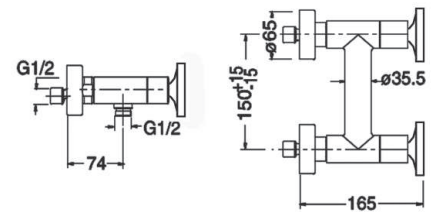
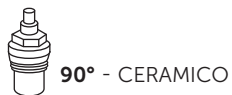

PC 60 CS 20

Gruppo lavello parete, canna inferiore cm. 20
Wall sink mixer, inferior spout cm. 20
Spülbeckengruppe für die Wand, unterer Auslauf, 20 cm

PC 60 CS 20

- CR
- BO - NO
- NI - BR - RA
- GLD - CPR - GNM
- OR

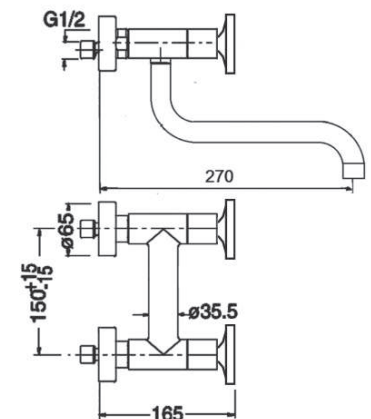
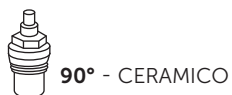

CUCINA

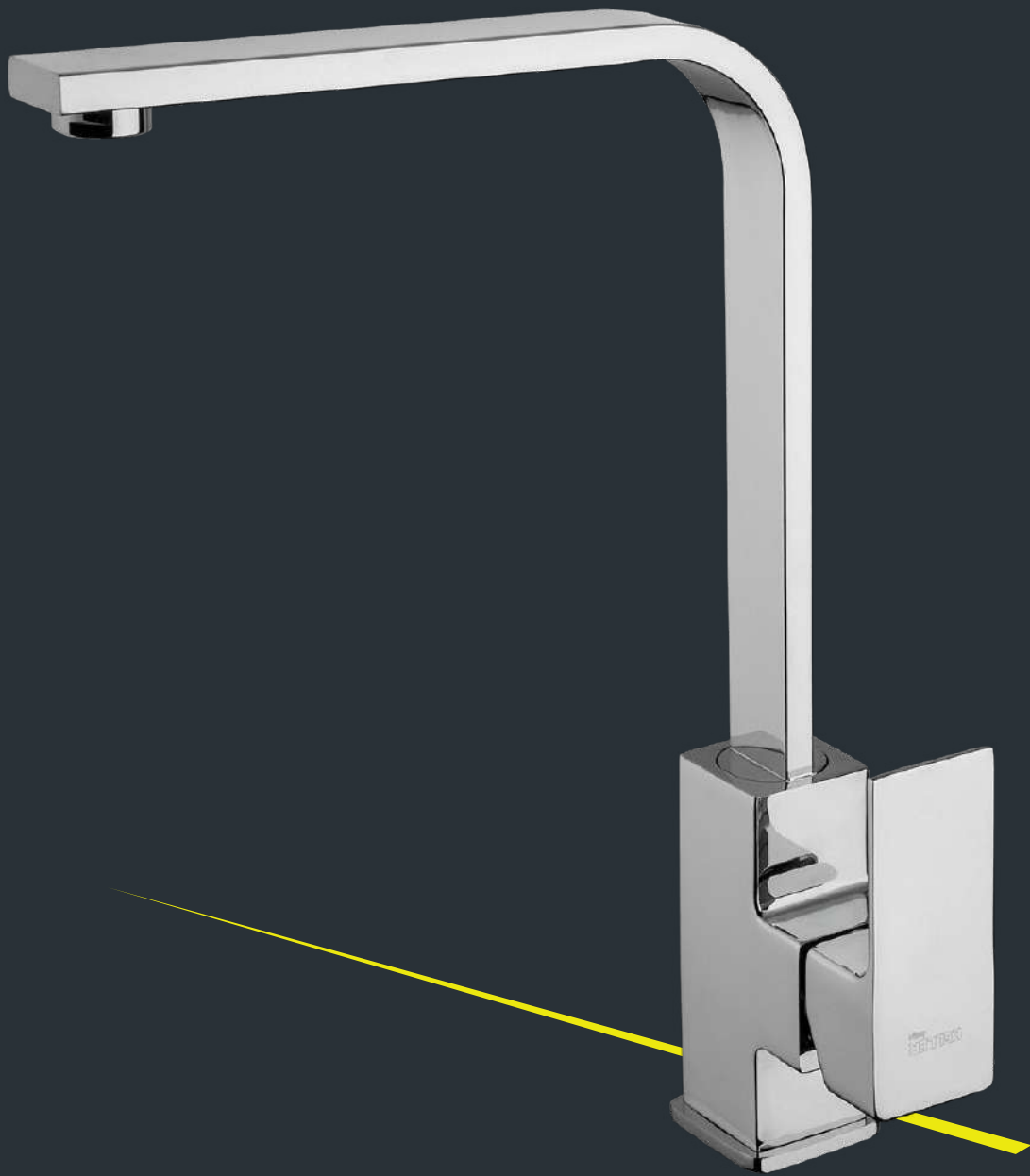

NEW

SA70CGBI

Monocomando cucina con canna snodata bianca
Single lever sink mixer
Küchen-Einhebelmischbatterie

SA70CGBI

CR

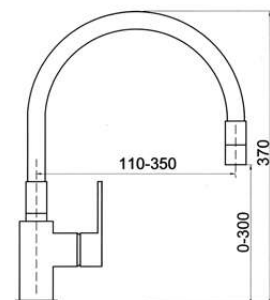

SA70CGBL

Monocomando cucina con canna snodata blu
Single lever sink mixer
Küchen-Einhebelmischbatterie

SA70CGBL

CR

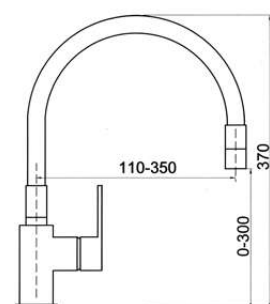

SA70CGAR

Monocomando cucina con canna snodata arancione
Single lever sink mixer
Küchen-Einhebelmischbatterie

SA70CGAR

CR

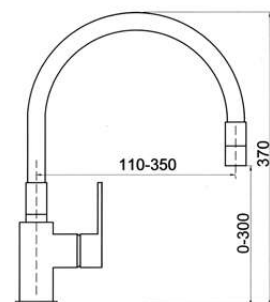

SA70CGGR

Monocomando cucina con canna snodata grigia
Single lever sink mixer
Küchen-Einhebelmischbatterie

SA70CGGR

CR

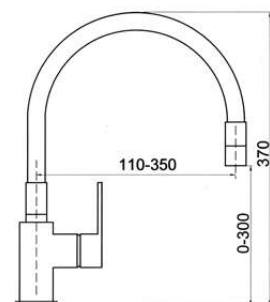

SA70CGGI

Monocomando cucina con canna snodata gialla
Single lever sink mixer
Küchen-Einhebelmischbatterie

SA70CGGI

CR

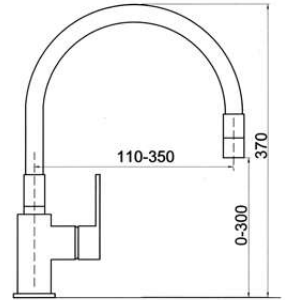

Ø 35 mm

**SA70CGNE**

Monocomando cucina con canna snodata nera
Single lever sink mixer
Küchen-Einhebelmischbatterie

SA70CGNE

CR

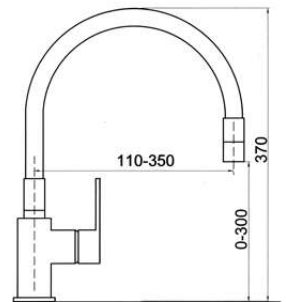

Ø 35 mm

**SA70CGRO**

Monocomando cucina con canna snodata rossa
Single lever sink mixer
Küchen-Einhebelmischbatterie

SA70CGRO

CR

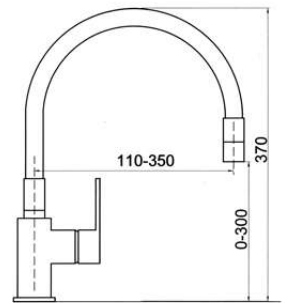

Ø 35 mm

**SA70CGVE**

Monocomando cucina con canna snodata verde
Single lever sink mixer
Küchen-Einhebelmischbatterie

SA70CGVE

CR



Ø 35 mm

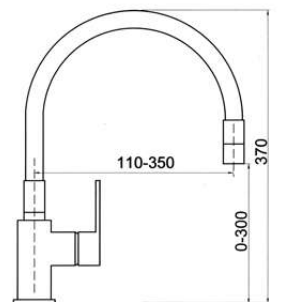



CR

NO

NI

WN 70 CAO - WINTER

Monocomando cucina canna alta
One-hole sink mixer, high spout
Küchen-Einhebelmischbatterie mit hohem Auslauf

NEW

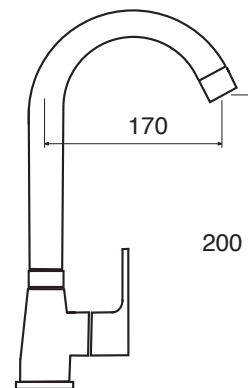

WN 70 CAO

CR

NO

NI



IX 70 DE

Monocomando cucina canna alta con doccino
estraibile
One-hole sink mixer, high spout
Küchen-Einhebelmischbatterie mit hohem Auslauf

NEW

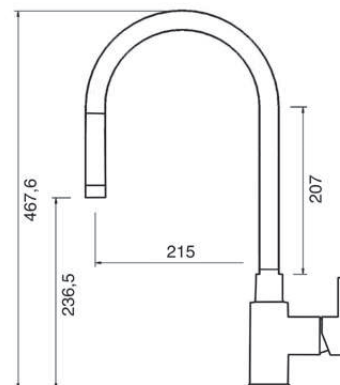

IX 70 DE

INOX



IX 70 CAO

Monocomando cucina canna alta
One-hole sink mixer, high spout
Küchen-Einhebelmischbatterie mit hohem Auslauf

NEW

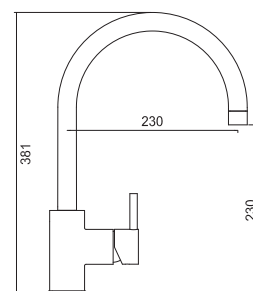

IX 70 CAO

CR

GLD - CPR - GNM



ZA017.5

Monocomando cucina canna nera
Single lever sink mixer
Küchen-Einhebelmischbatterie

ZA017.5

CR

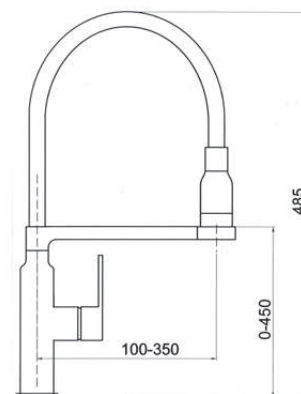

SA 72

Mix cucina con canna a taglio cromato
Chrome sink mixer
Küchen-Einhebelmischbatterie

SA 72

CR



Particolare aeratore a scomparsa
Retractable aerator detail

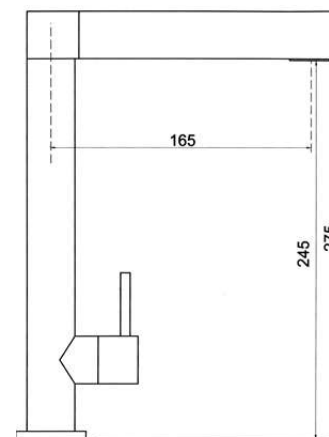

SK 70 CSQ

Monocomando cucina canna alta
One-hole sink mixer, high spout
Küchen-Einhebelmischbatterie mit hohem Auslauf

SK 70 CSQ

CR

NI



NEW

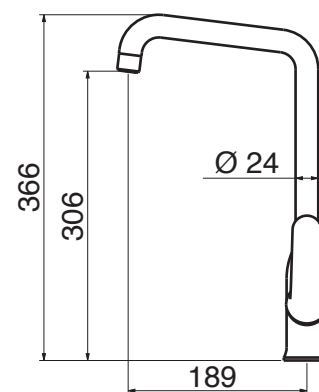

CO119.5/10

Monocomando cucina con canna snodata grigia
Single lever sink mixer
Küchen-Einhebelmischbatterie

CO119.5/10

CR

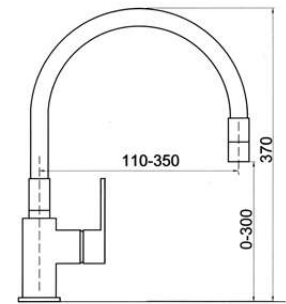

AM719.5/10C

Monocomando cucina con canna snodata nera
Single lever sink mixer
Küchen-Einhebelmischbatterie

AM719.5/10C

CR

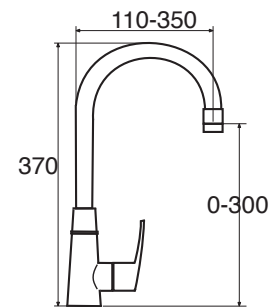

AM719.5/10B

Monocomando cucina con canna snodata bianca
Single lever sink mixer
Küchen-Einhebelmischbatterie

AM719.5/10B

CR

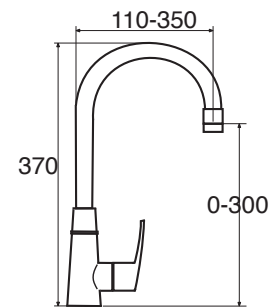

AM719.5/10R

Monocomando cucina con canna snodata lilla
Single lever sink mixer
Küchen-Einhebelmischbatterie

AM719.5/10R

CR

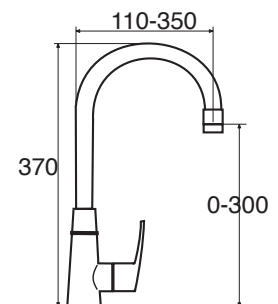

CO119.5/12

Monocomando cucina con canna snodata grigia
con aeratore regolabile 2 getti
Single lever sink mixer
Küchen-Einhebelmischbatterie

CO119.5/12

CR

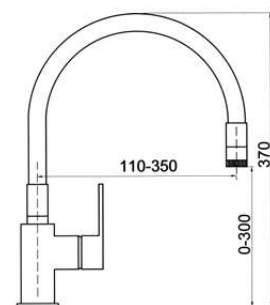

AM719.5/11C

Monocomando cucina con canna snodata nera
con aeratore regolabile 2 getti
Single lever sink mixer
Küchen-Einhebelmischbatterie

AM719.5/11C

CR

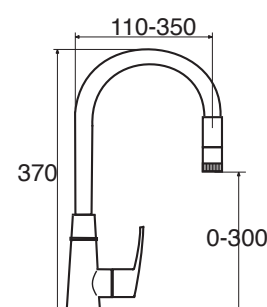

AM719.5/11B

Monocomando cucina con canna snodata bianca
con aeratore regolabile 2 getti
Single lever sink mixer
Küchen-Einhebelmischbatterie

AM719.5/11B

CR

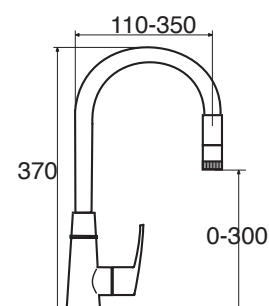

AM719.5/11R

Monocomando cucina con canna snodata lilla
con doccetta a 2 getti
Single lever sink mixer
Küchen-Einhebelmischbatterie

AM719.5/11R

CR

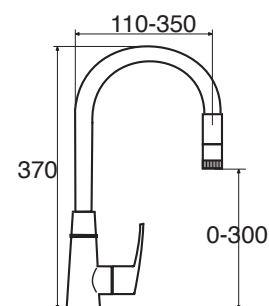



SQ 70

Monocomando cucina canna alta
One-hole sink mixer, high spout
 Küchen-Einhebelmischbatterie mit hohem Auslauf

SQ 70

CR
 NO
 NI

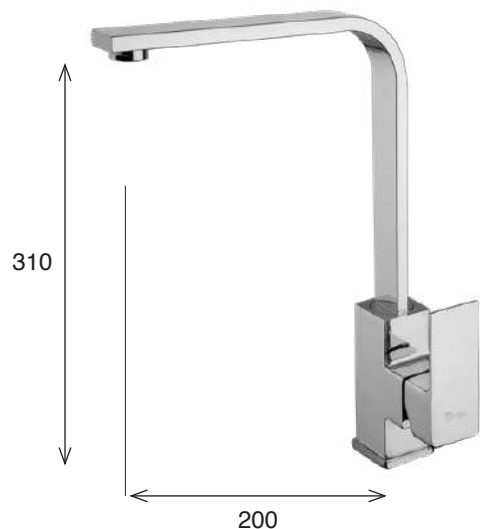

SA 70 CB - SATURNO

Monocomando cucina
Single lever sink mixer
 Küchen-Einhebelmischbatterie

SA 70 CB

CR

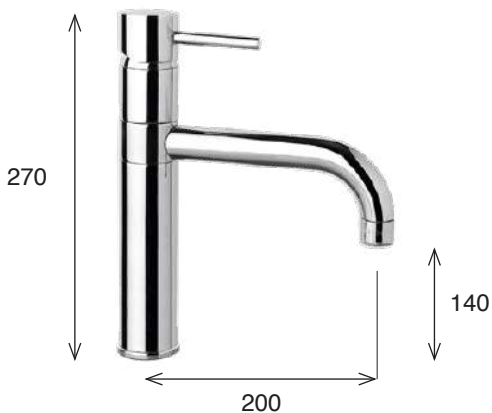

SA 70 CAO - SATURNO

Monocomando cucina canna alta
One-hole sink mixer, high spout
 Küchen-Einhebelmischbatterie mit hohem Auslauf

SA 70 CAO

CR
 BO - NO
 NI - BR - RA
 GLD - CPR - GNM
 OR



MI 70 CAO - MIMI

Monocomando cucina canna alta
One-hole sink mixer, high spout
 Küchen-Einhebelmischbatterie mit hohem Auslauf

MI 70 CAO

CR
 BO - NO
 NI - BR - RA
 GLD - CPR - GNM
 OR



NEW



SA 70 DEA - SATURNO

Monocomando cucina con doccia estraibile
Single lever sink mixer with extractable handshower
 Küchen-Einhebelmischbatterie mit herausziehbarer Schlauchbrause

SA 70 DEA

CR



SA 70 CAS - SATURNO

Monocomando cucina canna alta
One-hole sink mixer, high spout
 Küchen-Einhebelmischbatterie mit hohem Auslauf

SA 70 CAS

CR

BO - NO

NI - BR - RA

GLD - CPR - GNM

OR

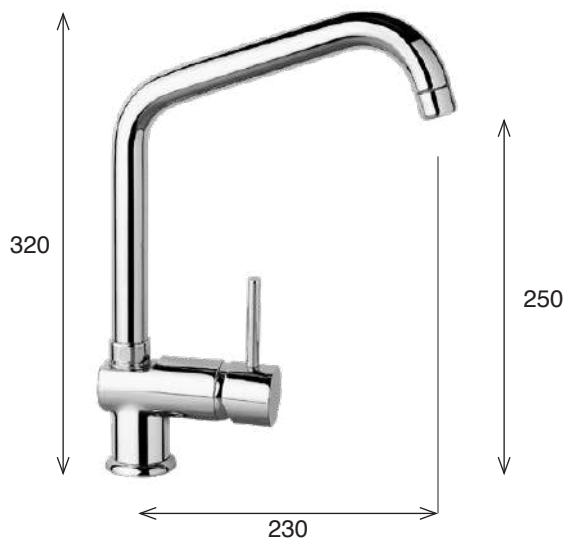

SA 70 MDA - SATURNO

Monocomando cucina canna alta a molla
One-hole sink mixer, high spout with torsion spring
 Küchen-Einhebelmischbatterie mit hohem Auslauf

SA 70 MDA

CR



SA 70 AE - SATURNO

Monocomando cucina con doccia estraibile
Single lever sink mixer with extractable handshower
 Küchen-Einhebelmischbatterie mit herausziehbarer Schlauchbrause

SA 70 AE

CR





CR



NO



BO



NI



BR



RA



GLD



CPR



GNM



OR

SA 70 SF - SATURNO

Monocomando cucina ribaltabile per sottofinestra
Single lever sink mixer tipping
Klapp-barer spültischeinhebelmischer unter
Fenstermontage

SA 70 SF

CR

NI - BR - RA

GLD - CPR - GNM

OR



ø 40 mm



SA 70 CAS 3V - SATURNO

Monocomando cucina 3 vie (acqua depurata)
Single-lever sink mixer 3 ways purified water
Spültischeinhebelmischer 3 weg geläuter für wasser

SA 70 CAS 3V

CR



ø 40 mm



SA 70 DEA 1 - SATURNO

Monocomando cucina con doccia estraibile
Single lever sink mixer with extractable handshower
 Küchen-Einhebelmischbatterie mit herausziehbare
 Schlauchbrause

SA 70 DEA 1

CR



FN 70 CB - FUSION

Monocomando cucina
Single lever sink mixer
 Küchen-Einhebelmischbatterie

FN 70 CB

CR



FN 70 CAS - FUSION

Monocomando cucina canna alta curva
Wall mounted sink mixer high spout
 Küchen-Einhebelmischbatterie mit hohem,
 gebogenem Auslauf

FN 70 CAS

CR

BO - NO

NI - BR - RA

OR



FN 71 CAC - FUSION

Monocomando cucina canna alta curva
Wall mounted sink mixer high spout
 Küchen-Einhebelmischbatterie mit hohem,
 gebogenem Auslauf

FN 71 CAC

CR

BO - NO

NI - BR - RA

OR





FN 70 DEB - FUSION

Monocomando cucina con doccia estraibile
Single-lever sink mixer with extractable handshower
Spültischeinhebelmischer mit herausziehbare Schlauchbrause

FN 70 DEB

CR



KS 70 CAO - KISS

Monoforo cucina, canna alta
Single hole sink mixer, high spout
Einloch-Küchenbatterie mit hohem Auslauf

KS 70 CAO

CR

BR - RA - NI

OR

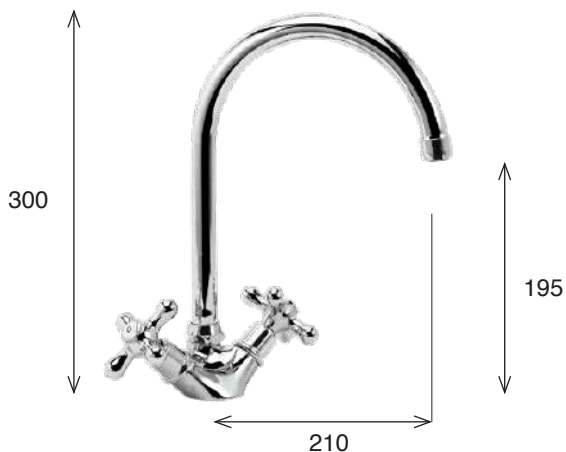
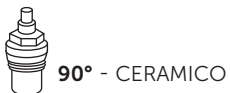

KS 70 BA - KISS

Monoforo cucina, bocca antica
Single hole sink mixer, antique spout
Einloch-Küchenbatterie, antiker Auslauf

KS 70 BA

CR

BR - RA - NI

OR

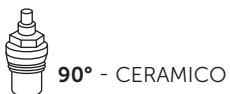

KN 70 BA - KING

Monoforo cucina, bocca antica
Single hole sink mixer, antique spout
Einloch-Küchenbatterie, antiker Auslauf

KN 70 BA

CR
 BR - RA - NI
 OR



90° - CERAMICO

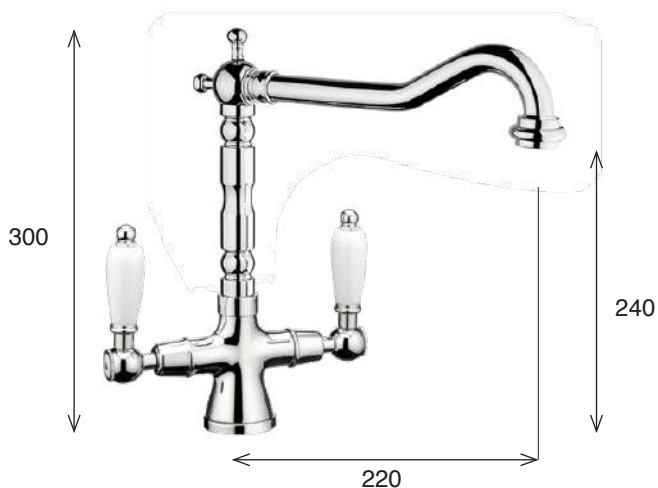

AN 70 BA - ANYA

Monoforo cucina, bocca antica
Single hole sink mixer, antique spout
Einloch-Küchenbatterie, antiker Auslauf

AN 70 BA

CR
 BR - RA - NI
 GLD - CPR - GNM
 OR



ø 40 mm

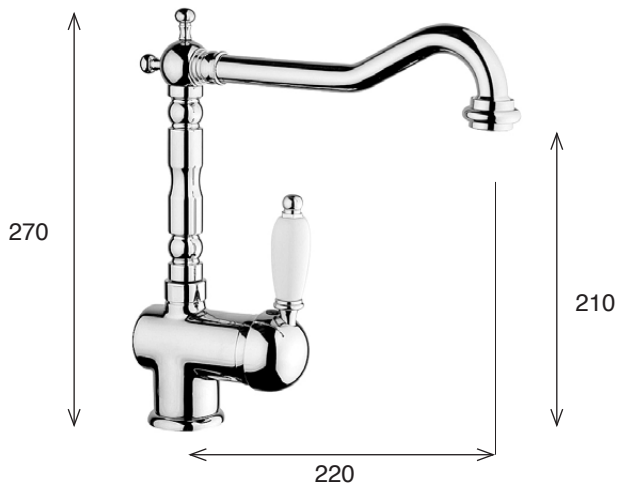

AN 70 SF BA - ANYA

Monocomando cucina ribaltabile per sottofinestra
Single lever sink mixer tipping
Klapp-barer spultischeinhebelmischer unter
Fenstermontage

AN 70 SF BA

CR
 BR - RA - NI
 GLD - CPR - GNM
 OR



ø 40 mm

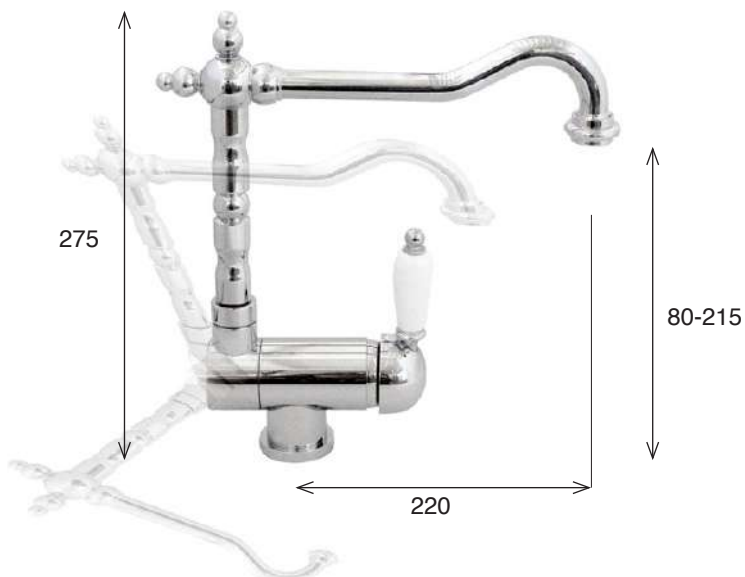



AN 71 BA - ANYA

Monocomando cucina bocca antica
One-hole sink mixer, antique spout
Küchen-Einhebelmischbatterie mit antiker Auslauf

AN 71 BA

- _____ CR
- _____ BR - RA - NI
- _____ GLD - CPR - GNM
- _____ OR



SI 70 CAO - SIRIO

Monocomando cucina canna alta
One-hole sink mixer, high spout
Küchen-Einhebelmischbatterie mit hohem Auslauf

SI 70 CAO

- _____ CR
- _____ BO - NO
- _____ NI - BR - RA
- _____ GLD - CPR - GNM
- _____ OR

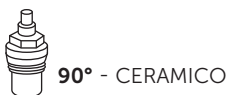

AT 70 CAO - ATLANTIC

Monocomando cucina canna alta
One-hole sink mixer, high spout
Küchen-Einhebelmischbatterie mit hohem Auslauf



SI 70 CAS

- _____ CR
- _____ BO - NO
- _____ NI - BR - RA
- _____ GLD - CPR - GNM
- _____ OR

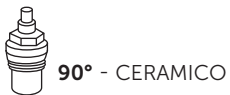

FN 70 CB BP - bassa pressione

Monocomando cucina
Single lever sink mixer
Küchen-Einhebelmischbatterie

FN 70 CB BP

CR

 Bassa pressione
Low pressure
Niederdruck-küchenbatterie



FN 70 SB BP - bassa pressione

Monocomando cucina sottoboiler
Under boiler kitchen single lever
Einhebel-Küchenmischbatterie, Unterbau für
Boiler

FN 70 SB BP

CR

 Bassa pressione
Low pressure
Niederdruck-küchenbatterie



KS 70 CAO BP - bassa pressione

Monoforo cucina, canna alta
Single hole sink mixer, high spout
Einloch-Küchenbatterie mit hohem Auslauf

KS 70 CAO BP

CR

BR - RA - NI

OR

 Bassa pressione
Low pressure
Niederdruck-küchenbatterie



KS 70 BA BP - bassa pressione

Monoforo cucina, bocca antica
Single hole sink mixer, antique spout
Einloch-Küchenbatterie, antiker Auslauf

KS 70 BA BP

CR

BR - RA - NI

OR

 Bassa pressione
Low pressure
Niederdruck-küchenbatterie



THERMO





TH 26

Termostatico incasso doccia 160x235 mm,
con deviatore a 2-3-4 uscite
*Built-in thermostatic shower mixer 160x235 mm,
with diverter with 2-3-4 outputs*
*Thermostatmischer für Dusche zum Einbau
mit Umschaltventil*

TH 26

- _____ CR
- _____ BO - NO
- _____ NI - BR - RA
- _____ GLD - CPR - GNM
- _____ OR

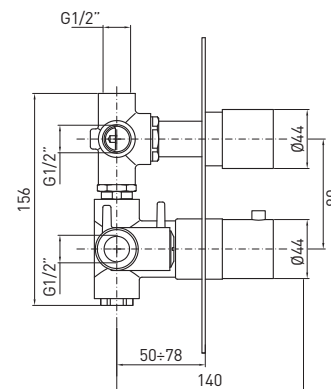
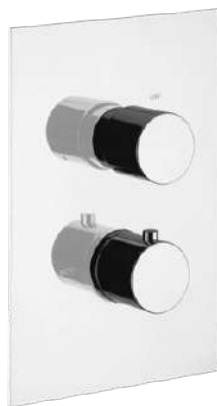

TH 36

Termostatico incasso doccia 160x235 mm,
con deviatore a 2-3-4 uscite
*Built-in thermostatic shower mixer 160x235 mm,
with diverter with 2-3-4 outputs*
*Thermostatmischer für Dusche zum Einbau
mit Umschaltventil*

TH 36

- _____ CR
- _____ BO - NO
- _____ NI - BR - RA
- _____ GLD - CPR - GNM
- _____ OR

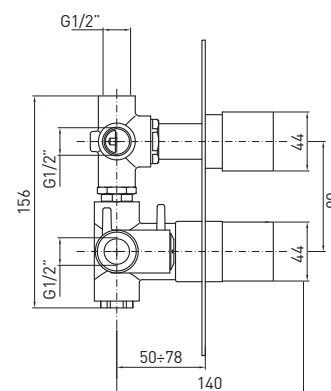
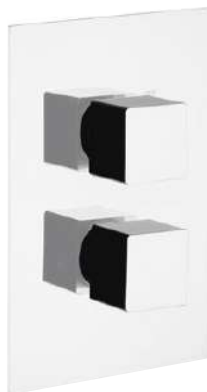

TH 56

Termostatico gruppo doccia esterno
Wall mtd shower unit thermostat control
Thermostatique groupe externe de douche

Art. _____
TH 56

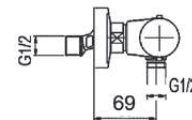
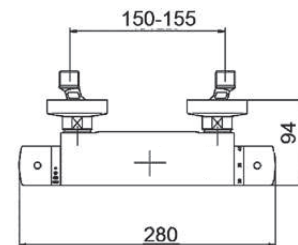

TH 58

Termostatico per colonna doccia
Thermostatic mixer for column shower
Thermostatischer für Duschsäule

Art. _____
TH 58

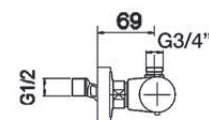
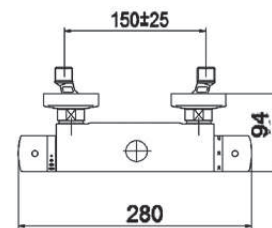

TERMOSTATICI

TH 59

Termostatico per colonna doccia con deviatore
Thermostatic mixer for column shower with diverter
Thermostatischer für Duschsäule mit Umsteller

TH 59

CR
 BO - NO
 NI - BR - RA

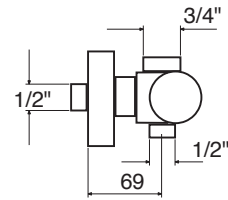
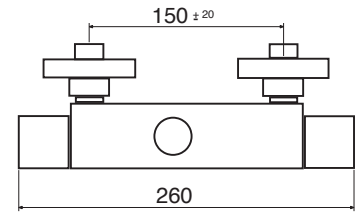

TH 66

Termostatico gruppo doccia esterno
Wall mtd shower unit thermostat control
Thermostatische groupe externe de douche

Art. _____

TH 66

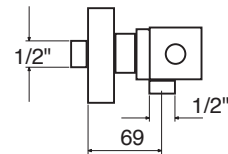
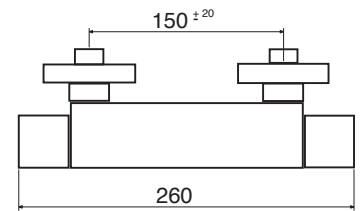

TH 68

Termostatico per colonna doccia
Thermostatic mixer for column shower
Thermostatischer für Duschsäule

Art. _____

TH 68

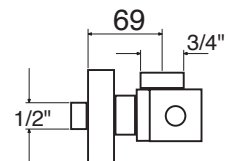
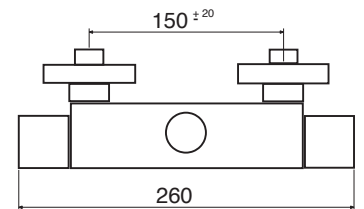

TH 69

Termostatico per colonna doccia con deviatore
Thermostatic mixer for column shower with diverter
Thermostatischer für Duschsäule mit Umsteller

TH 69

CR
 BO - NO
 NI - BR - RA

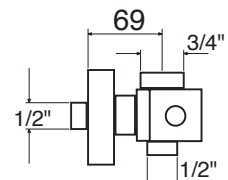
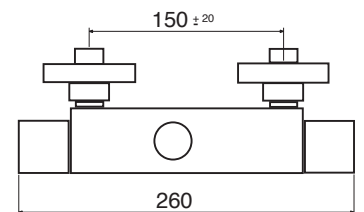



COLONNE DOCCIA

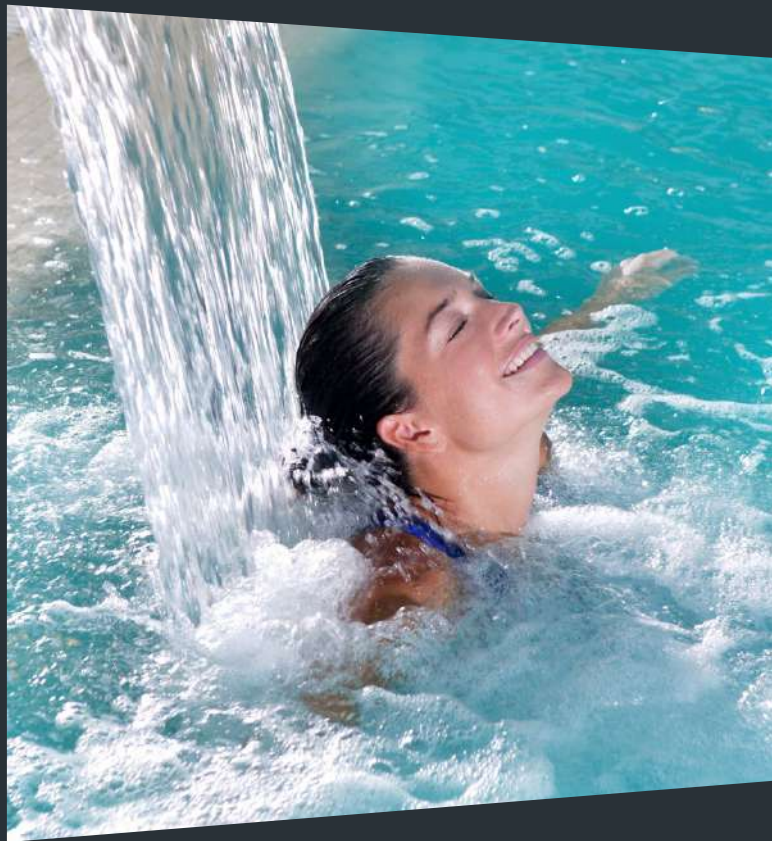



4003 - INOX LUCIDO

Colonna doccia incasso in acciaio inox lucido con soffione a pioggia e soffioni laterali. Dotata di TERMOSTATICO, deviatore, flessibile e doccetta. *Steel chromed recessed column set with thermostatic mixer, diverter included, front idro-jets, handshower and flexible hose.*

Art.
4003

4002 - INOX LUCIDO / NERO OPACO

Colonna doccia sospesa in acciaio inox lucido o nero con soffione a pioggia, soffioni laterali e cascata. Dotata di MISCELATORE, deviatore, flessibile e doccetta. *Chromed inox column set with mixer, diverter included, front idro-jets, waterfall, handshower and flexible hose.*

4002
INOX LUCIDO
NO



COLONNE DOCCIA



4001 - INOX LUCIDO / NERO OPACO / BIANCO OPACO

Colonna doccia sospesa in acciaio inox lucido o nero/bianco opaco con soffione a pioggia e soffioni laterali. Dotata di MISCELATORE, deviatore, flessibile e doccetta. *Chromed inox column set with mixer, diverter included, front idro-jets, handshower and flexible hose.*

4001

INOX LUCIDO
BO - NO

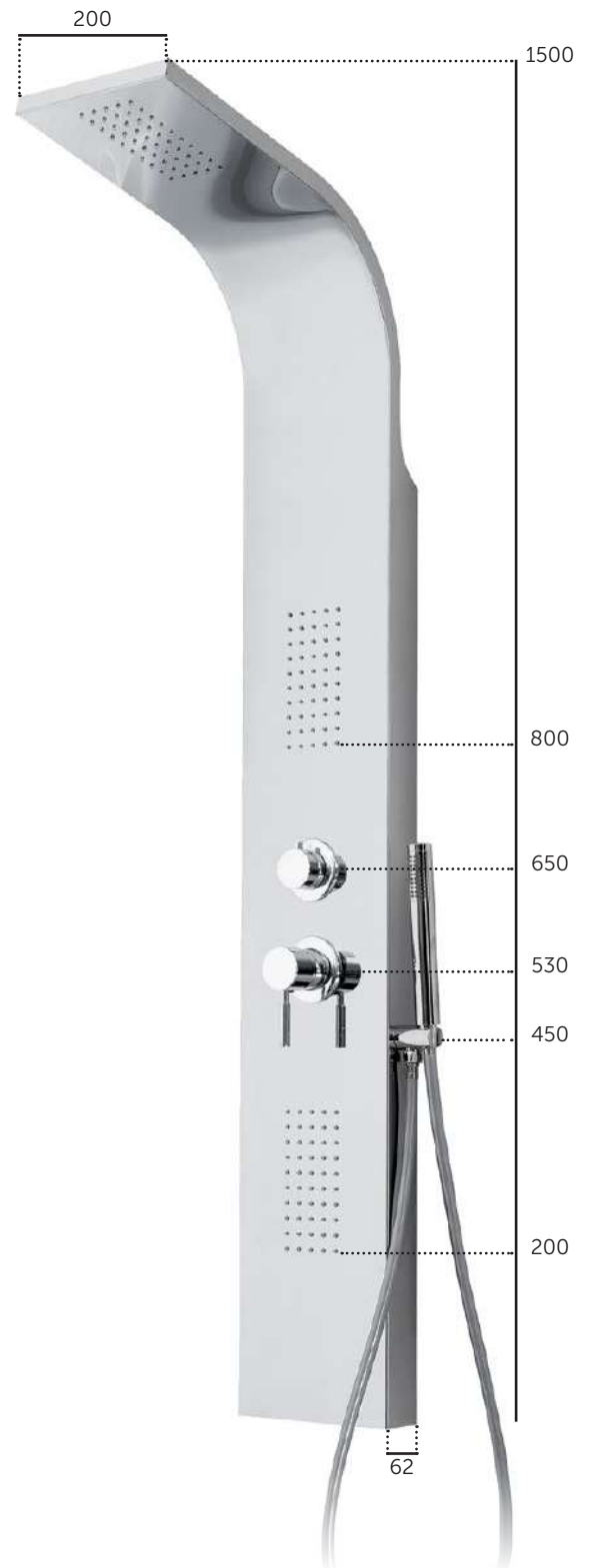

4000 - INOX LUCIDO

Colonna doccia sospesa in acciaio inox lucido con soffione a pioggia e soffioni laterali. Dotata di MISCELATORE, deviatore, flessibile e doccetta. *Chromed inox column set with mixer, diverter included, front idro-jets, handshower and flexible hose.*

Art.

4000

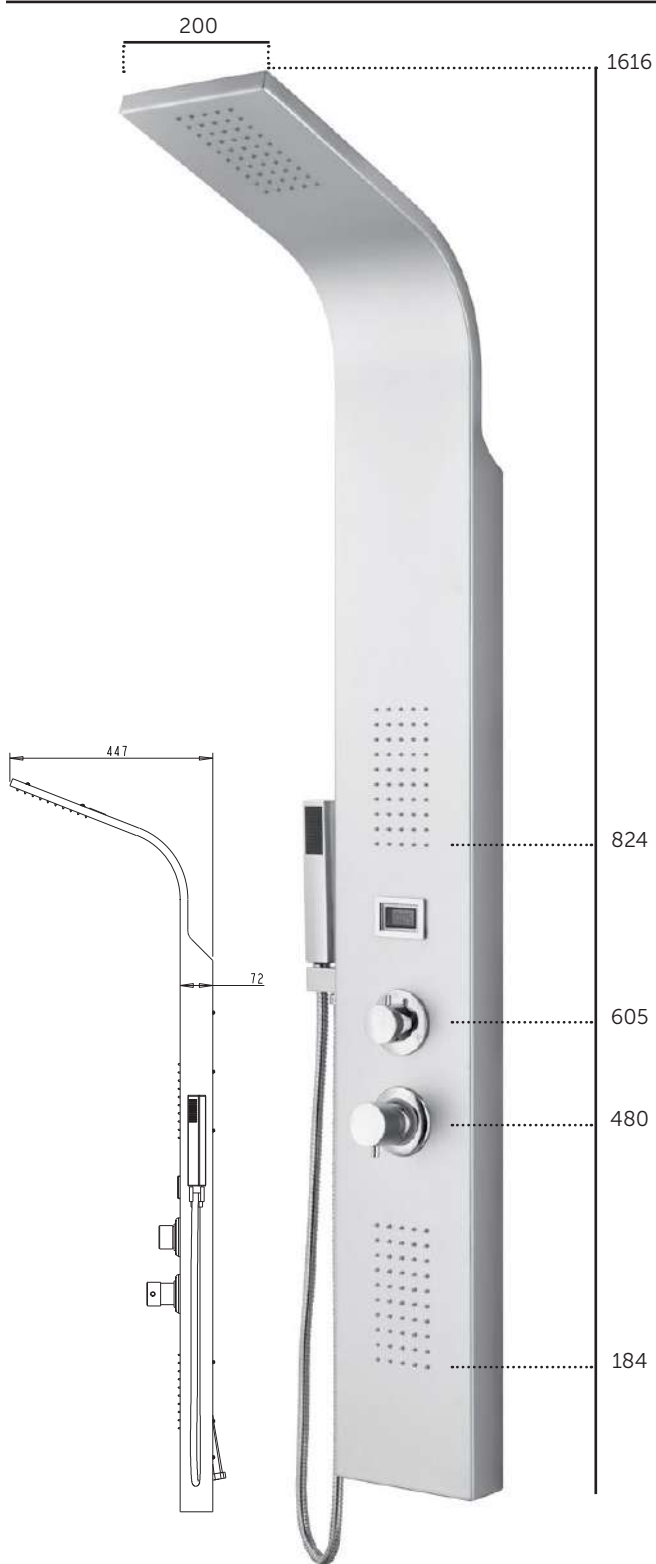

4004 - ALLUMINIO SATINATO

Colonna in alluminio satinato multifunzione anticalcare con miscelatore e display temperatura.
Antiscale stainless steel shower column multifunction with mixer and temperature display.

Art.
4004



4005 - ALLUMINIO BIANCO / NERO OPACO

Colonna in alluminio bianca o nera multifunzione anticalcare con miscelatore e getto a cascata.
Antiscale aluminium shower column multifunction with mixer and waterfall jet.

4005
 BO - NO



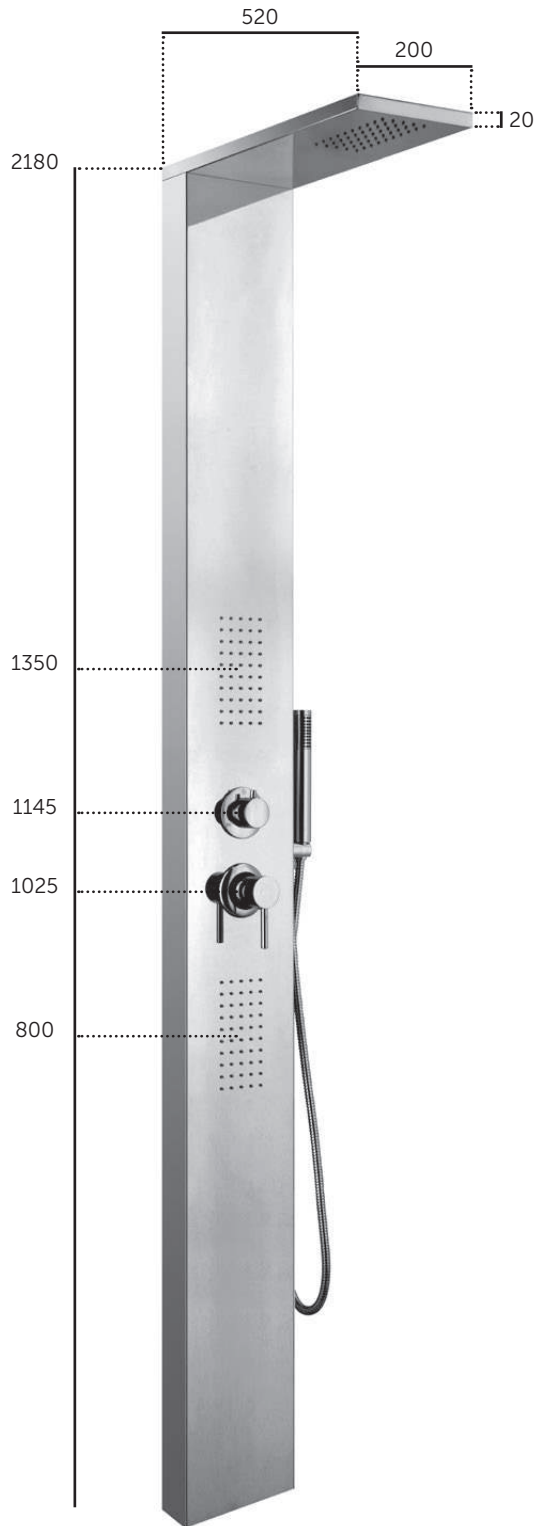

4006 - INOX LUCIDO

Colonna doccia da pavimento in acciaio inox lucido con soffione a pioggia e soffioni laterali.
Dotata di MISCELATORE, deviatore, flessibile e doccetta.
Chromed inox column set with mixer, diverter included, front idro-jets, handshower and flexible hose.

Art.
4006



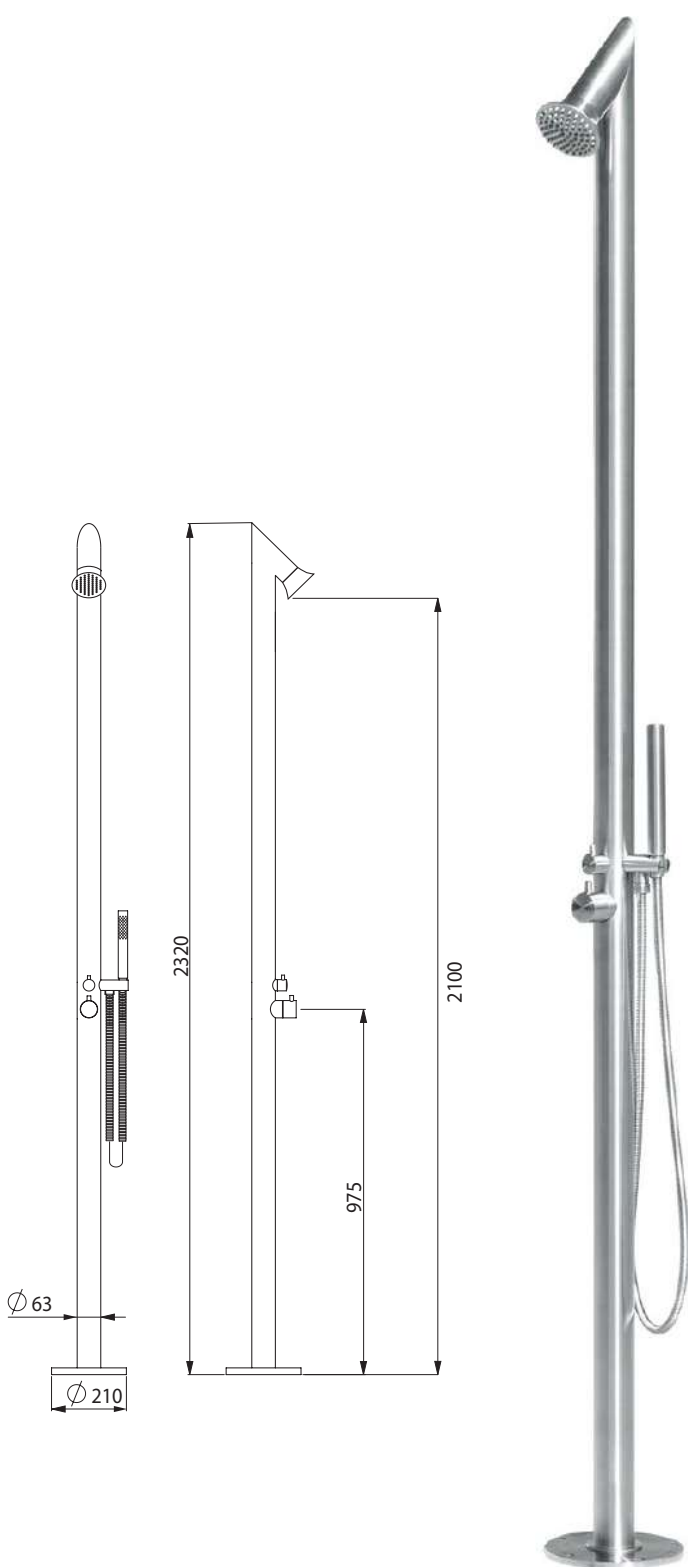

4010 - INOX 316 L

Set colonna da esterno in acciaio inox spazzolato 316 L,
con miscelatore e deviatore incorporati.
Brushed stainless steel 316 L column set, mixer and diverter included.

Art.
4010

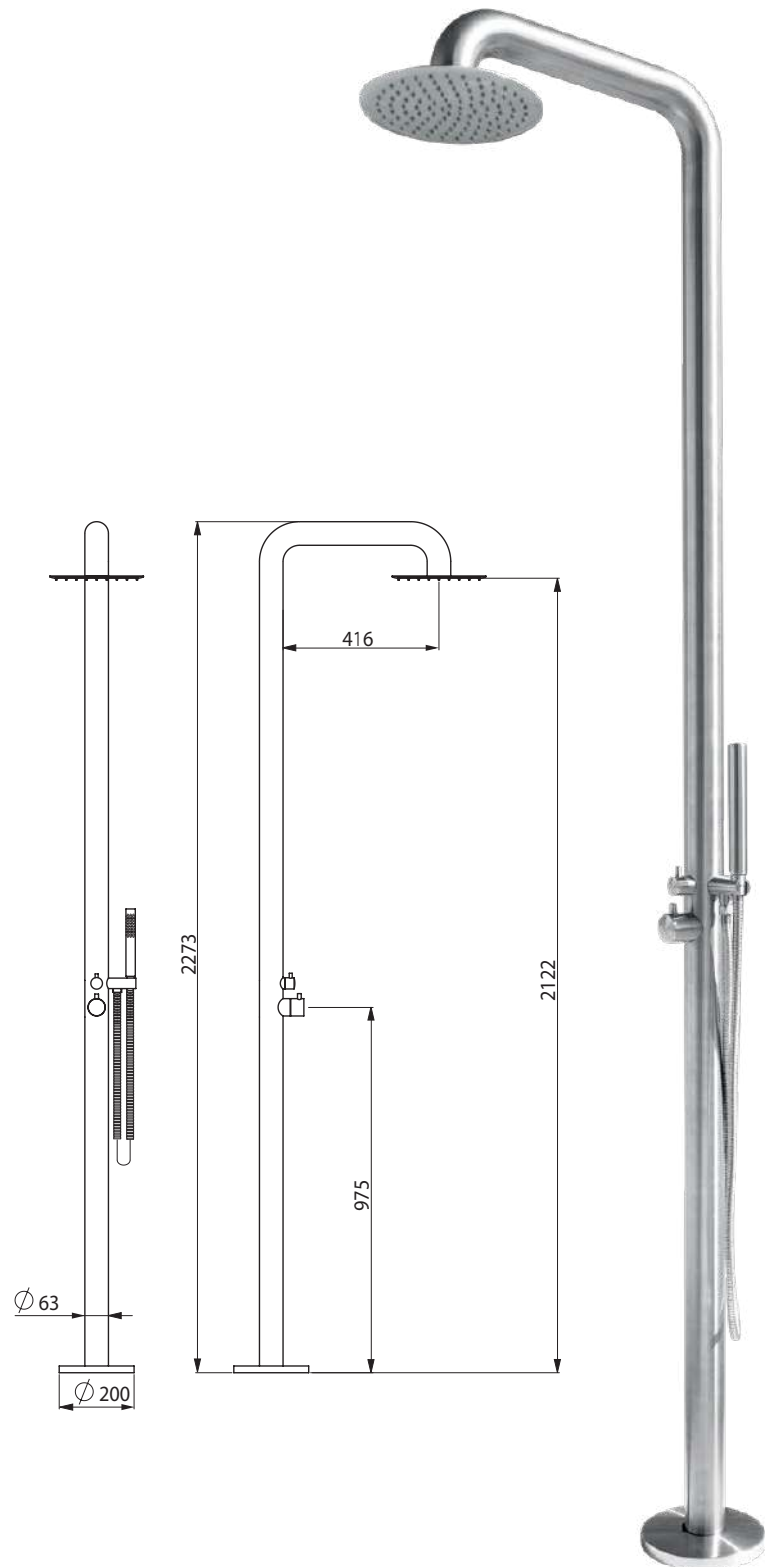

4011 - INOX 316 L

Set colonna da esterno in acciaio inox spazzolato 316 L,
con miscelatore e deviatore incorporati.
Brushed stainless steel 316 L column set, mixer and diverter included.

Art.
4011

serie 500 EMOTIONS

Pacchetto doccia completo con soffione doccia, soffione a cascata, mix incasso e kit doccia con supporto.
Shower kit.

Art.

KIT completo

Soffione doccia cm. 250x250
in acciaio inox ultrasottile con braccio cm. 35.
Ultrathin shower heads, in square shape with shower arm 35 cm.
Riesenbrausekopf mit brausenarm 35 cm.

Art. soffione

15025 **Quadrato**

Soffione Tucano in acciaio inox a cascata ultrasottile.
Nice curved wall waterfall.
Riesenbrausekopf.

Art. soffione

6085 **a cascata**

Mix incasso doccia con deviatore a 3 uscite.
Single lever for built-in shower with diverter with 3 outputs.
Einhebelmischbatterie für Dusche zum Einbau mit Umschaltventil.

Art. leva

SY41/3 **Quadrato**

Kit doccia con supporto doccetta con presa acqua, flessibile silver e doccetta quadrata abs.
Square water supply with support, silver flexible and abs shower.

Art. doccetta

SH99 **Quadrato**

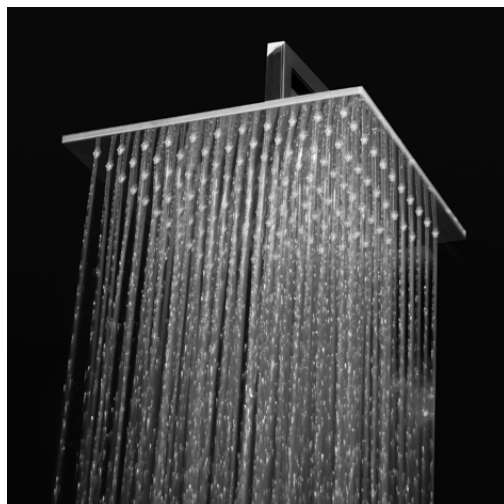



CR

NO

NI

serie 500 CLASSIC

Pacchetto doccia completo con soffione doccia rettangolare con cascata, mix incasso e kit doccia con supporto.

Shower kit.

KIT completo

CR

NO

NI

Soffione doccia rettangolare in acciaio inox con cascata, spessore 24 mm.

Rectangular shower head, with waterfall.

Riesenbrausekopf.

Art. soffione

6165 Rettangolare

Mix incasso doccia con deviatore a 3 uscite.

Single lever for built-in shower with diverter with 3 outputs.

Einhebelmischbatterie für Dusche zum Einbau mit Umschaltventil.

Art. leva

SY41/3 Mix

Kit doccia con supporto doccetta quadrato con presa acqua, flessibile silver e doccetta quadrata abs.

Square water supply with support, silver flexible and abs shower.

Art. doccetta

SH99 Quadrato



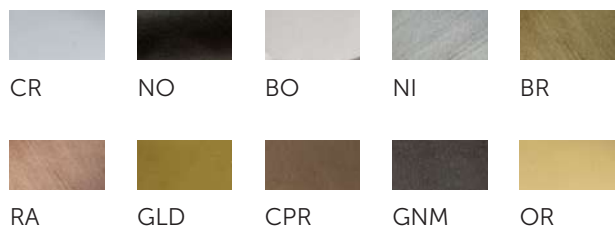

COLONNE DOCCIA



NOTB
Nero opaco total black
con ugelli neri

14005 - 14007

Kit soffione cilindrico diametro mm 200, 250 o 300 con **TERMOSTATICO** incasso doccia, deviatore a 2 uscite + kit doccia cilindrico con presa acqua, flessibile cm 150 e doccetta cilindrica.

Shower kit with headshower and thermostatic mixer + water supply with flexible hose and handshower.

Art.		soffione	Ø mm.
14005/20	CR	ABS	200
14007/20	CR	INOX	200
14007/25	CR	INOX	250
14007/25	NO - BO	OTTONE	250
14007/25	NOTB	INOX	250
14007/25	NI	INOX	250
14007/25	BR - RA	OTTONE	250
14007/25	GLD - CPR - GNM	INOX	250
14007/25	OR	OTTONE	250
14007/30	CR	INOX	300

14008 - 14009

Kit soffione cilindrico diametro mm 200, 250 o 300 con **MISCELATORE** incasso doccia, deviatore a 2 uscite + kit doccia cilindrico con presa acqua, flessibile cm 150 e doccetta cilindrica.

Shower kit with headshower and mixer + water supply with flexible hose and handshower.

Art.		soffione	Ø mm.
14008/20	CR	ABS	200
14009/20	CR	INOX	200
14009/25	CR	INOX	250
14009/25	NO - BO	OTTONE	250
14009/25	NOTB	INOX	250
14009/25	NI	INOX	250
14009/25	BR - RA	OTTONE	250
14009/25	GLD - CPR - GNM	INOX	250
14009/25	OR	OTTONE	250
14009/30	CR	INOX	300

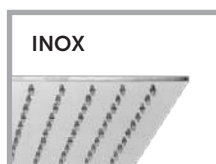
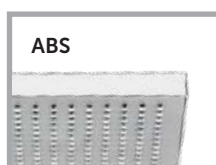
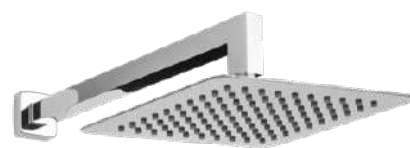

NOTB
Nero opaco total black
con ugelli neri



14015 - 14017

Kit soffione quadrato mm 200, 250 o 300 con **TERMOSTATICO** incasso doccia, deviatore a 2 uscite + kit doccia quadrato con presa acqua, flessibile cm 150 e doccetta quadrata.

Shower kit with headshower and thermostatic mixer + water supply with flexible hose and handshower.

Art.		soffione	mm.
14015/20	CR	ABS	200x200
14017/20	CR	INOX	200x200
14017/25	CR	INOX	250x250
14017/25	NO - BO	OTTONE	250x250
14017/25	NOTB	INOX	250x250
14017/25	NI	INOX	250x250
14017/25	BR - RA	OTTONE	250x250
14017/25	GLD - CPR - GNM	INOX	250x250
14017/25	OR	OTTONE	250x250
14017/30	CR	INOX	300x300

14018 - 14019

Kit soffione quadrato mm 200, 250 o 300 con **MISCELATORE** incasso doccia, deviatore a 2 uscite + kit doccia quadrato con presa acqua, flessibile cm 150 e doccetta quadrata.

Shower kit with headshower and thermostatic mixer + water supply with flexible hose and handshower.

Art.		soffione	mm.
14018/20	CR	ABS	200x200
14019/20	CR	INOX	200x200
14019/25	CR	INOX	250x250
14019/25	NO - BO	OTTONE	250x250
14019/25	NOTB	INOX	250x250
14019/25	NI	INOX	250x250
14019/25	BR - RA	OTTONE	250x250
14019/25	GLD - CPR - GNM	INOX	250x250
14019/25	OR	OTTONE	250x250
14019/30	CR	INOX	300x300



COLONNE DOCCIA

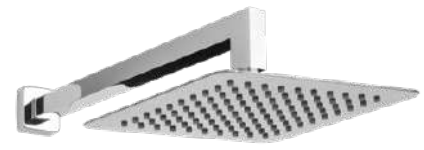

ABS

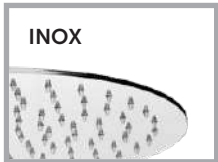

INOX



INOX

NOTB
Nero opaco total black
con ugelli neri

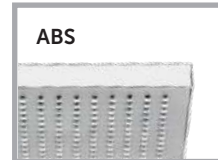

ABS

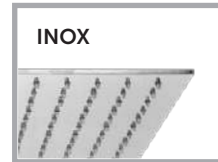

INOX

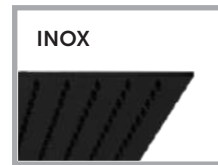

INOX

NOTB
Nero opaco total black
con ugelli neri



14005 A - 14007 A

Kit soffione cilindrico diametro mm 200, 250 o 300 con kit doccia cilindrico con presa acqua, flessibile cm 150 e doccetta cilindrica.
Shower kit with headshower + water supply with flexible hose and handshower.

Art.	soffione	Ø mm.
14005 A/20 CR	ABS	200
14007 A/20 CR	INOX	200
14007 A/25 CR	INOX	250
14007 A/25 NO - BO	OTTONE	250
14007 A/25 NOTB	INOX	250
14007 A/25 NI	INOX	250
14007 A/25 BR - RA	OTTONE	250
14007 A/25 GLD - CPR - GNM	INOX	250
14007 A/25 OR	OTTONE	250
14007 A/30 CR	INOX	300

14015 A - 14017 A

Kit soffione quadrato mm 200, 250 o 300 con kit doccia quadrato con presa acqua, flessibile cm 150 e doccetta quadrata.
Shower kit with headshower + water supply with flexible hose and handshower.

Art.	soffione	mm.
14015 A/20 CR	ABS	200x200
14017 A/20 CR	INOX	200x200
14017 A/25 CR	INOX	250x250
14017 A/25 NO - BO	OTTONE	250x250
14017 A/25 NOTB	INOX	250x250
14017 A/25 NI	INOX	250x250
14017 A/25 BR - RA	OTTONE	250x250
14017 A/25 GLD - CPR - GNM	INOX	250x250
14017 A/25 OR	OTTONE	250x250
14017 A/30 CR	INOX	300x300



Incasso doccia a doppia uscita esterno senza deviatore estremamente innovativo e molto facile da utilizzare. Con un semplice movimento rotatorio della leva si passa velocemente dal soffione alla doccetta e viceversa. La cartuccia a dischi ceramici utilizzata è del tipo a "risparmio energetico" infatti, nelle prime fasi dell'utilizzo del soffione o della doccetta, l'acqua calda non viene utilizzata.

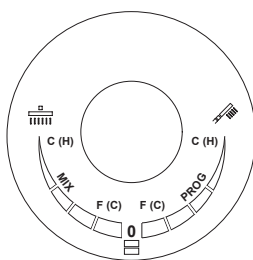

A highly innovative and user friendly built-in shower mixer with two outlets without diverter. By simply rotating the lever water swiftly goes from the showerhead to the handspray and back to the showerhead. Fitted with a water saving ceramic disc cartridge it does not make use of hot water in the early stage of activation of the showerhead and the handspray.

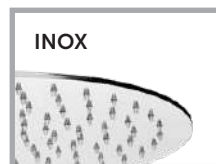

NOTB
Nero opaco total black con ugelli neri



13062

Kit colonna doccia stile antico, **MISCELATORE** dotato di deviatore, soffione Ø 200 in ottone, doccetta ottone e flessibile cm 150.
Old fashion shower column, mixer with diverter, brass headshower Ø 200 mm and flexible cm 150.

13062

CR
BR - RA - NI
OR

14010 - 14011

Kit soffione cilindrico diametro mm 200, 250 o 300 con **MISCELATORE** incasso doccia dotato di deviatore + kit doccia cilindrico con presa acqua, flessibile cm 150 e doccetta cilindrica.

Shower kit with headshower and mixer with diverter + water supply with flexible hose and handshower.

Art.		soffione	Ø mm.
14010/20	CR	ABS	200
14011/20	CR	INOX	200
14011/25	CR	INOX	250
14011/25	NO - BO	OTTONE	250
14011/25	NOTB	INOX	250
14011/25	NI	INOX	250
14011/25	BR - RA	OTTONE	250
14011/25	GLD - CPR - GNM	INOX	250
14011/25	OR	OTTONE	250
14011/30	CR	INOX	300



COLONNE DOCCIA

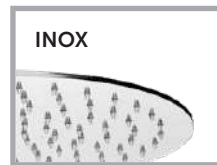

NOTB
Nero opaco total black
con ugelli neri



13075 - 13077

Kit colonna doccia cilindrica con soffione diametro mm 200, 250 o 300, **TERMOSTATICO** cilindrico dotato di deviatore, flessibile cm 150 e doccetta cilindrica.

Shower columns with headshower Ø 200/250/300 mm, thermostatic mixer with diverter, flexible cm 150 and handshower.

Art.		soffione	Ø mm.
13075/20	CR	ABS	200
13077/20	CR	INOX	200
13077/25	CR	INOX	250
13077/25	NO - NOTB	INOX	250
13077/25	BO	OTTONE	250
13077/25	NI	INOX	250
13077/25	BR - RA	OTTONE	250
13077/30	CR	INOX	300

13100 - 13101

Kit colonna doccia cilindrica con soffione diametro mm 200, 250 o 300, **MISCELATORE** cilindrico dotato di deviatore, flessibile cm 150 e doccetta cilindrica.

Shower columns with headshower Ø 200/250/300 mm, mixer with diverter, flexible cm 150 and handshower.

Art.		soffione	Ø mm.
13100/20	CR	ABS	200
13101/20	CR	INOX	200
13101/25	CR	INOX	250
13101/25	NO - NOTB	INOX	250
13101/25	BO	OTTONE	250
13101/25	NI	INOX	250
13101/25	BR - RA	OTTONE	250
13101/25	OR	OTTONE	250
13101/30	CR	INOX	300

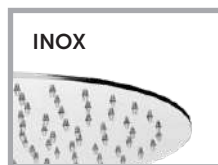

NOTB
Nero opaco total black
con ugelli neri



13075 A - 13077 A

Kit colonna doccia cilindrica con deviatore e soffione Ø mm 200, 250 o 300, flessibile cm 60, presa acqua, flessibile cm 150 e doccetta cilindrica.
Shower columns with diverter and inox or abs headshower Ø 200/250/300 mm, flexible cm 60, water supply, flexible cm 150 and handshower.

Art.	soffione	Ø mm.
13075 A/20 CR	ABS	200
13077 A/20 CR	INOX	200
13077 A/25 CR	INOX	250
13077 A/25 NO - NOTB	INOX	250
13077 A/25 BO	OTTONE	250
13077 A/25 NI	INOX	250
13077 A/25 BR - RA	OTTONE	250
13077 A/30 CR	INOX	300

13075 B - 13077 B

Kit colonna doccia cilindrica con deviatore e soffione diametro mm 200, 250 o 300, presa acqua, flessibile cm 150 e doccetta cilindrica.
Shower columns with diverter and inox or abs headshower Ø 200/250/300 mm, water supply, flexible cm 150 and handshower.

Art.	soffione	Ø mm.
13075 B/20 CR	ABS	200
13077 B/20 CR	INOX	200
13077 B/25 CR	INOX	250
13077 B/25 NO - NOTB	INOX	250
13077 B/25 BO	OTTONE	250
13077 B/25 NI	INOX	250
13077 B/25 BR - RA	OTTONE	250
13077 B/30 CR	INOX	300



COLONNE DOCCIA

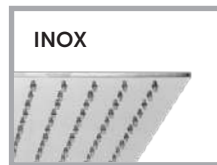
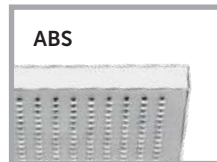

NOTB
Nero opaco total black
con ugelli neri



13086 - 13087

Kit colonna doccia cilindrica con soffione quadrato mm 200, 250 o 300, **TERMOSTATICO** quadrato dotato di deviatore, flessibile cm 150 e doccetta quadrata.

Shower columns with inox or abs headshower 200/250/300 mm, thermostatic mixer with diverter, flexible cm 150 and abs handshower.

Art.		soffione	mm.
13086/20	CR	ABS	200x200
13087/20	CR	INOX	200x200
13087/25	CR	INOX	250x250
13087/25	NO - NOTB	INOX	250x250
13087/25	BO	OTTONE	250x250
13087/25	NI	INOX	250x250
13087/25	BR - RA	OTTONE	250x250
13087/30	CR	INOX	300x300

13110 - 13111

Kit colonna doccia cilindrica con soffione quadrato mm 200, 250 o 300, **MISCELATORE** quadrato dotato di deviatore, flessibile cm 150 e doccetta quadrata.

Shower columns with headshower 200/250/300 mm, mixer with diverter, flexible cm 150 and handshower.

Art.		soffione	mm.
13110/20	CR	ABS	200x200
13111/20	CR	INOX	200x200
13111/25	CR	INOX	250x250
13111/25	NO - NOTB	INOX	250x250
13111/25	BO	OTTONE	250x250
13111/25	NI	INOX	250x250
13111/25	BR - RA	OTTONE	250x250
13111/30	CR	INOX	300x300

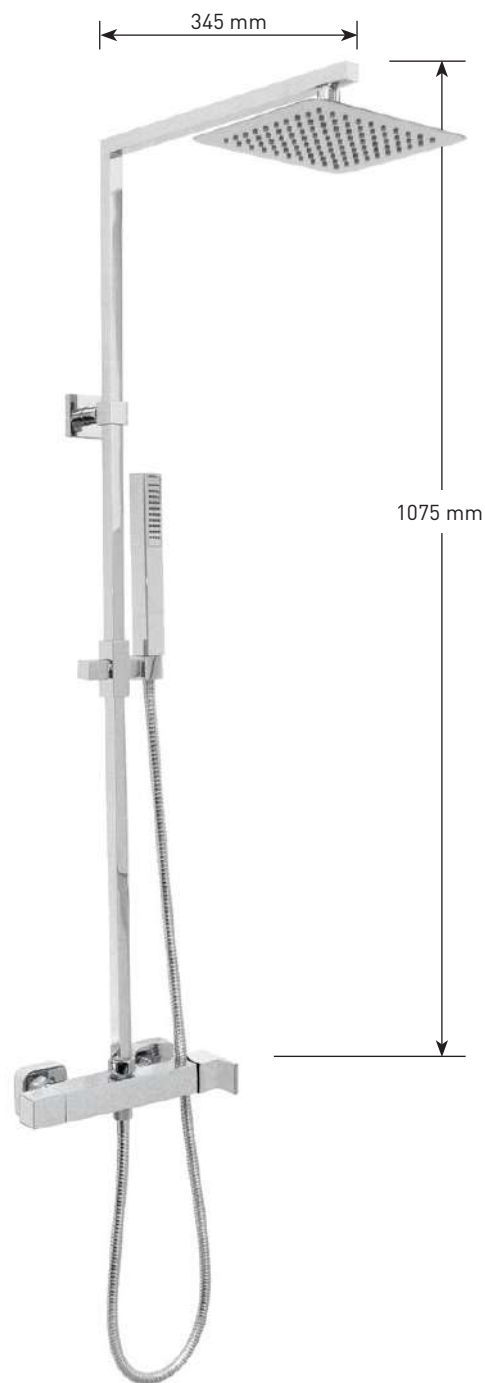
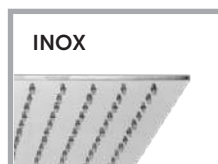
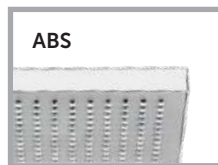
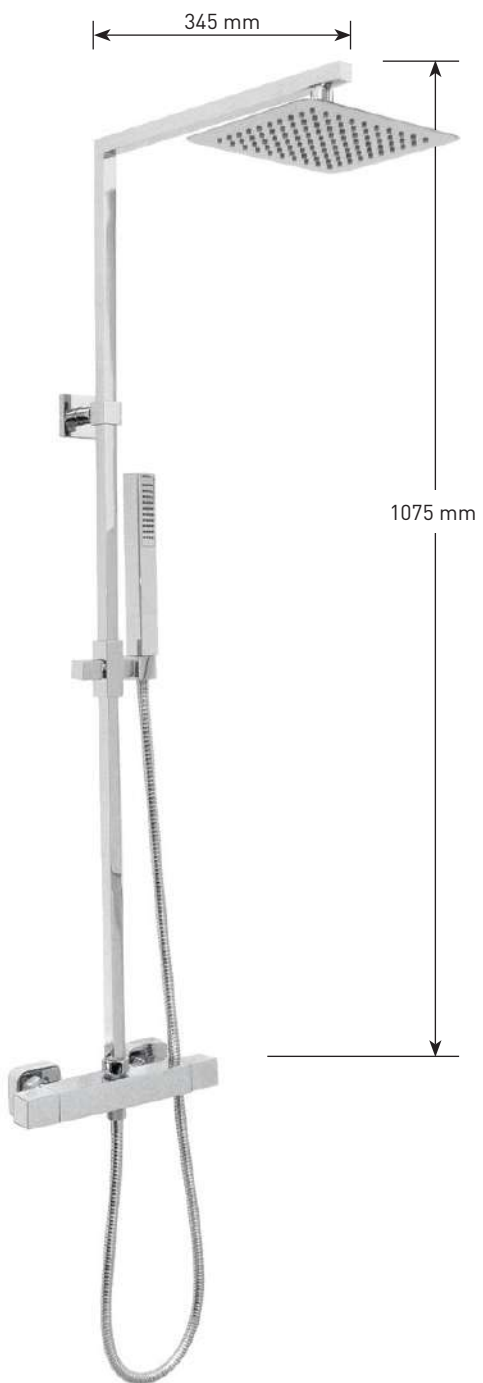

13095 - 13097

Kit colonna doccia quadrata, soffione quadrato mm 200, 250 o 300, **TERMOSTATICO** quadrato con deviatore, flessibile cm 150 e doccetta quadrata. Finitura cromata.

Shower columns, headshower 200/250/300 mm, thermostatic mixer with diverter, flexible cm 150 and handshower.

Art.	soffione	mm.
13095/20	ABS	200x200
13097/20	INOX	200x200
13097/25	INOX	250x250
13097/30	INOX	300x300

13198 - 13199

Kit colonna doccia quadrata con deviatore, soffione quadrato mm 200, 250 o 300, **MISCELATORE** quadrato, flessibile cm 150 e doccetta quadrata. Finitura cromata.

Shower columns with diverter, headshower 200/250/300 mm, mixer, flexible cm 150 and handshower.

Art.	soffione	mm.
13198/20	ABS	200x200
13199/20	INOX	200x200
13199/25	INOX	250x250
13199/30	INOX	300x300



COLONNE DOCCIA

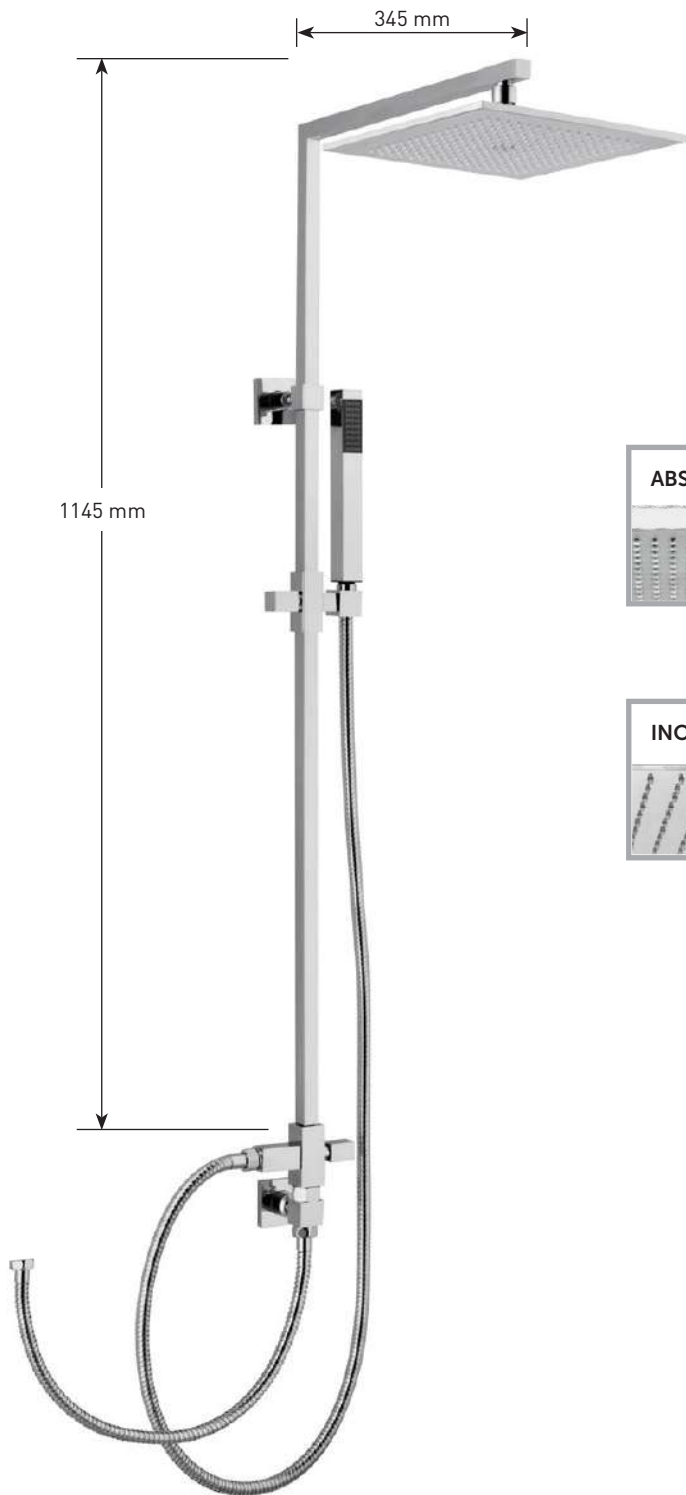

13095 A - 13097 A

Kit colonna doccia quadrata con deviatore, soffione quadrato mm 200, 250 o 300, flessibile cm 60, presa acqua, flessibile cm 150 e doccetta quadrata. Finitura cromata.

Shower columns with headshower 200/250/300 mm, flexible cm 60, water supply, flexible cm 150 and handshower.

Art.	soffione	mm.
13095 A/20	ABS	200x200
13097 A/20	INOX	200x200
13097 A/25	INOX	250x250
13097 A/30	INOX	300x300

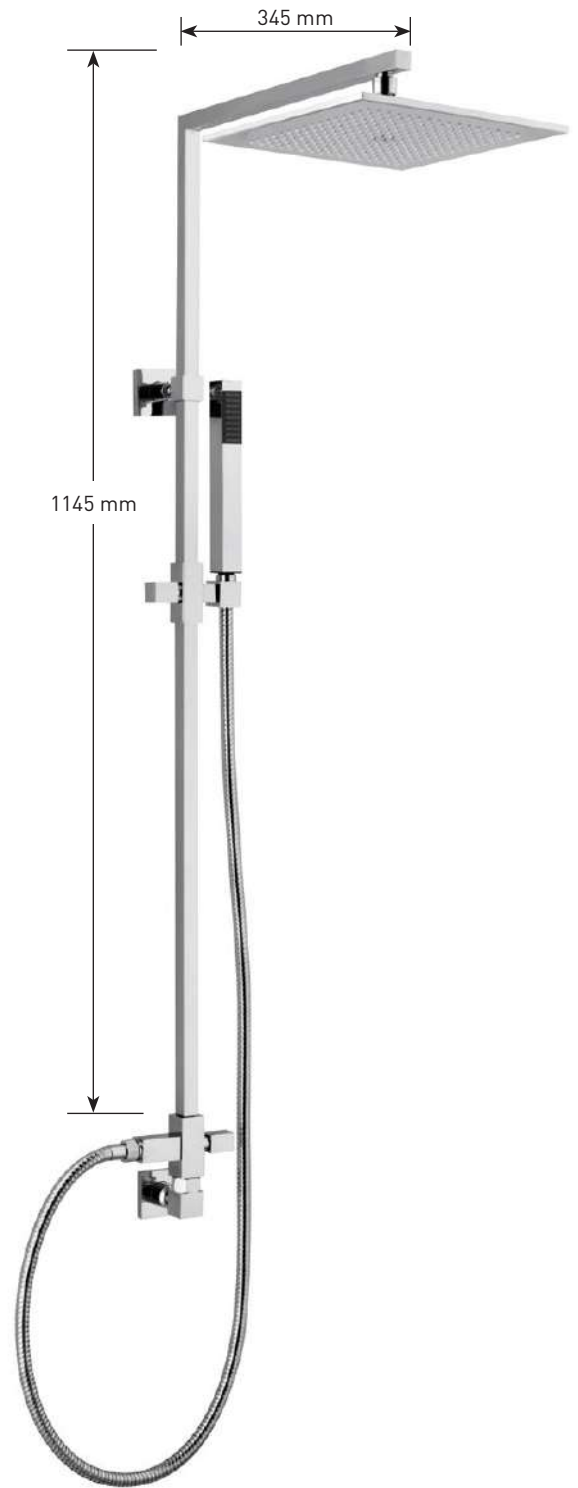

13095 B - 13097 B

Kit colonna doccia quadrata con deviatore, soffione quadrato mm 200, 250 o 300, presa acqua, flessibile cm 150 e doccetta quadrata. Finitura cromata.

Shower columns with headshower 200/250/300 mm, water supply, flexible cm 150 and handshower.

Art.	soffione	mm.
13095 B/20	ABS	200x200
13097 B/20	INOX	200x200
13097 B/25	INOX	250x250
13097 B/30	INOX	300x300



CR NI BR RA OR



13061

Kit colonna doccia stile antico con deviatore, soffione Ø 200 in ottone, doccetta ottone e gruppo doccia.
Old fashion shower columns with diverter, brass headshower Ø 200 mm and brass handshower.

13061

CR
BR - RA - NI
OR



13061 A

Kit colonna doccia stile antico con deviatore, soffione Ø 200 in ottone, flessibile cm 60, presa acqua, flessibile cm 150 e doccetta ottone. Finitura cromata.
Old fashion shower columns with diverter, brass headshower Ø 200 mm, flexible cm 60, water supply, flexible cm 150 and brass handshower.

13061 A

CR
BR - RA - NI
OR





13061 B

Kit colonna doccia stile antico con deviatore, soffione Ø 200 in ottone, presa acqua, flessibile cm 150 e doccetta ottone.

Finitura cromata.

Old fashion shower columns with diverter, brass headshower Ø 200 mm, water supply, flexible cm 150 and brass handshower.

13061 B

CR

BR - RA - NI

OR

SOFFIONI E BRACCI





INOX

CHROMOTHERAPY



Tipologia	1 Bar L/min.	2 Bar L/min.	3 Bar L/min.
	11	17	22
	6,4	8	10
	10	14	18

- Pioggia
Rain shower
Regenschauer
- Nebulizzazione
Fogging
Fogging
- Cascata
Waterfall
Wasserfall
- Cromoterapia
Chromotherapy
Farbtherapie

Alimentazione 220V, con trasformatore e telecomando.

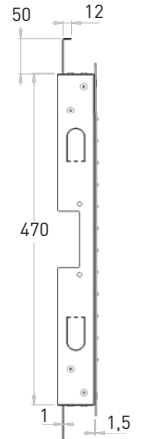
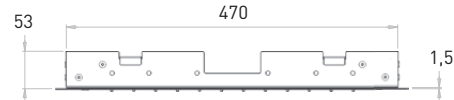
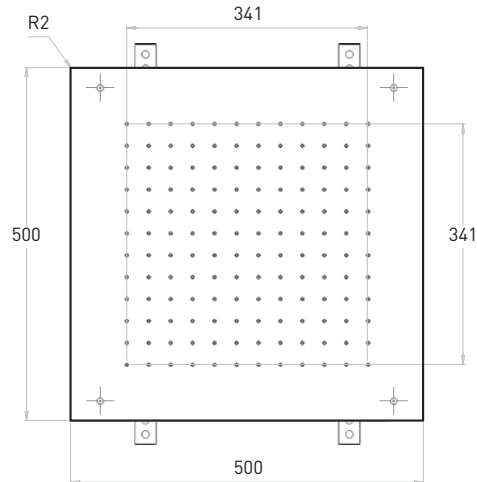
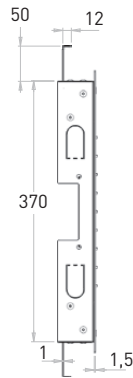
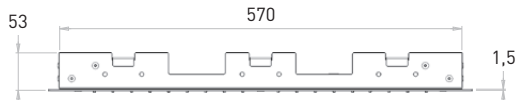
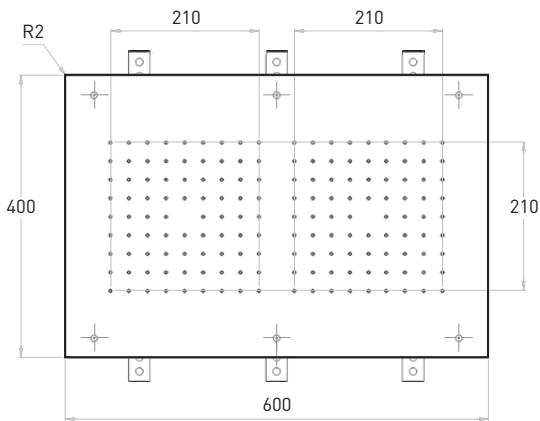

MAGIC 60x40 - INOX

Soffione doccia anticalcare a soffitto, 600 x 400 mm.
Antiscale shower heads, 600 x 400 mm.
Riesenbrausekopf, 600 x 400 mm.

Art.					
75040	CR - NI	✓			
75040	NO - BO	✓			
75040	GLD - CPR - GNM - OR	✓			
75030	CR - NI	✓	✓		
75030	NO - BO	✓	✓		
75030	GLD - CPR - GNM - OR	✓	✓		
75034	CR - NI	✓	✓	✓	
75034	NO - BO	✓	✓	✓	
75034	GLD - CPR - GNM - OR	✓	✓	✓	
75035	CR - NI	✓	✓	✓	✓
75035	NO - BO	✓	✓	✓	✓
75035	GLD - CPR - GNM - OR	✓	✓	✓	✓

MAGIC 50x50 - INOX

Soffione doccia anticalcare a soffitto, 500 x 500 mm.
Antiscale shower heads, 500 x 500 mm.
Riesenbrausekopf, 500 x 500 mm.

Art.					
74220	CR - NI	✓			
74220	NO - BO	✓			
74220	GLD - CPR - GNM - OR	✓			
74230	CR - NI	✓	✓		
74230	NO - BO	✓	✓		
74230	GLD - CPR - GNM - OR	✓	✓		
74234	CR - NI	✓	✓	✓	
74234	NO - BO	✓	✓	✓	
74234	GLD - CPR - GNM - OR	✓	✓	✓	
74235	CR - NI	✓	✓	✓	✓
74235	NO - BO	✓	✓	✓	✓
74235	GLD - CPR - GNM - OR	✓	✓	✓	✓



3620/25

Braccio doccia snake con soffione Ø 250 mm
 Snake shower arm with round shower head Ø 250 mm
 Schlangenbrausearm mit rundem Duschkopf Ø 250 mm.

3620/25

CR
 BO - NO
 NI
 GLD - CPR - GNM

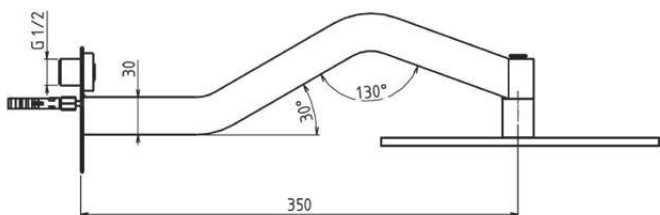
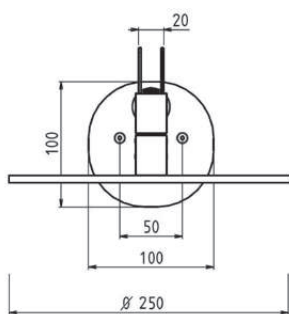



INOX

Acciaio INOX AISI304 AISI304 stainless steel

Lavorazione laser Laser processing

Pioggia Rain shower

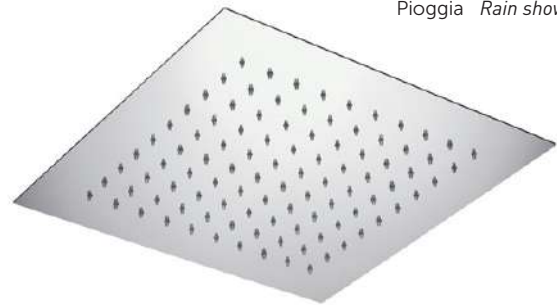

SISTEMA DI FISSAGGIO BREVETTATO

Questo sistema unisce due grandi benefici: la riduzione del 66% del tempo di installazione e l'assenza di viti di tiraggio nella parte estetica del prodotto. Il soffione si installa ricavando una semplice sede nel controsoffitto, il sistema Spring-Fix® permette poi l'installazione in qualche minuto soltanto senza bisogno di utensili.

PATENTED SYSTEM

This system combines two great benefits: a reduction by 66% of the installation time and no needs for screws on the aesthetic part of the rainshower. The product is installed by simply creating a sitting site in the false ceiling and the Spring-Fix® system will allow for a installation in a few minutes with no tools.

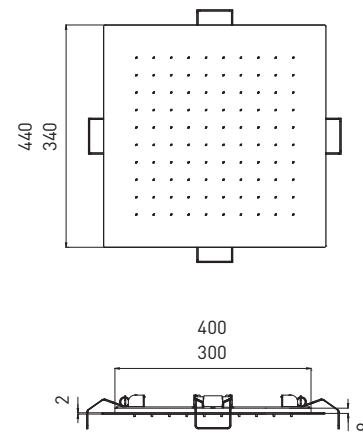
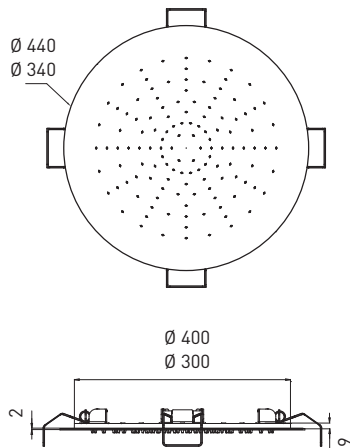

6026 - INOX AISI 304

Soffione ispezionabile tondo fissaggio a soffitto con sistema brevettato a molle.
Inspectable round showerhead with ceiling-mount spring patented system.

6046 - INOX AISI 304

Soffione ispezionabile quadro fissaggio a soffitto con sistema brevettato a molle.
Inspectable square showerhead with ceiling-mount spring patented system.

6026/34	Ø mm.
CR	340
NI	340
BO - NO	340
GLD - CPR - GNM - OR	340

6046/34	mm.
CR	340x340
NI	340x340
BO - NO	340x340
GLD - CPR - GNM - OR	340x340

6026/44	Ø mm.
CR	440
NI	440
BO - NO	440
GLD - CPR - GNM - OR	440

6046/44	mm.
CR	440x440
NI	440x440
BO - NO	440x440
GLD - CPR - GNM - OR	440x440



SOFFIONI e BRACCI INOX

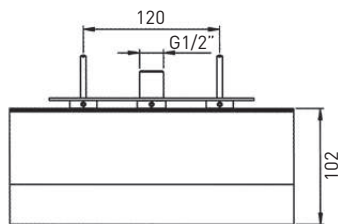
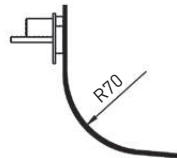
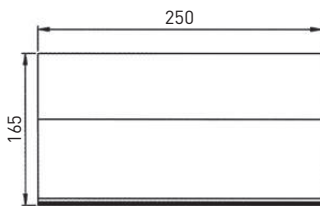
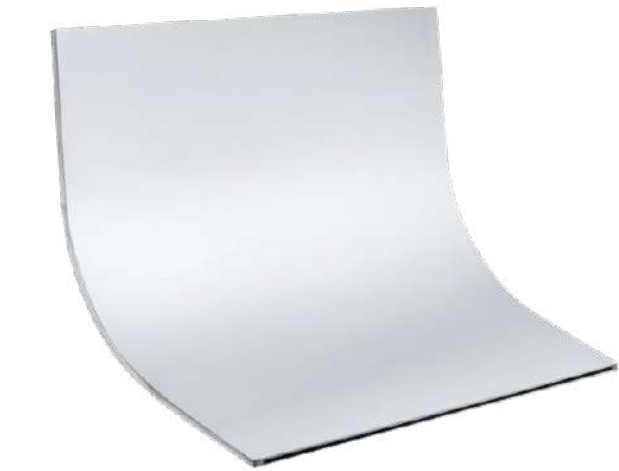

6085 TUCANO - INOX

Elegante cascata a muro curva.
Nice curved wall waterfall.

Art.	1 Bar L/min.	2 Bar L/min.	3 Bar L/min.
6085	12	18,5	23,5

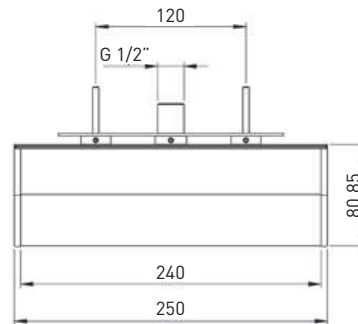
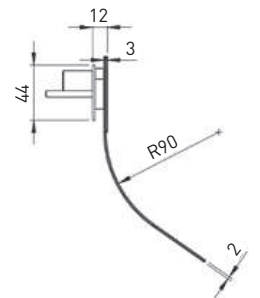

6086 TUCANO - INOX

Elegante cascata a muro curva.
Nice curved wall waterfall.

Art.	1 Bar L/min.	2 Bar L/min.	3 Bar L/min.
6086	12	18,5	23,5



CR

NI

INOX

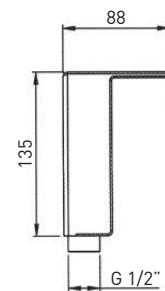
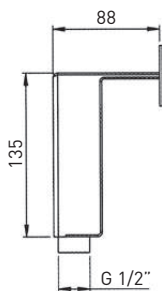
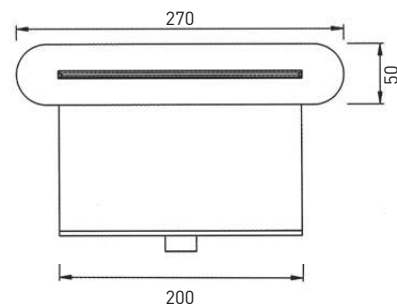
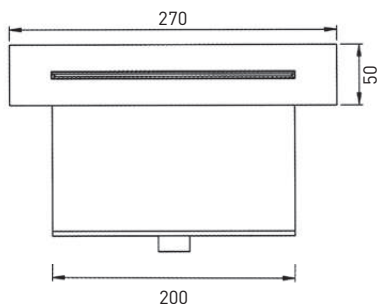
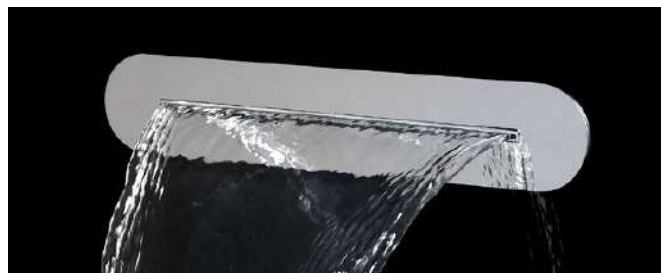
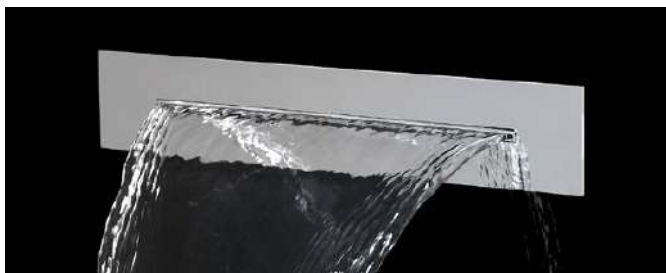
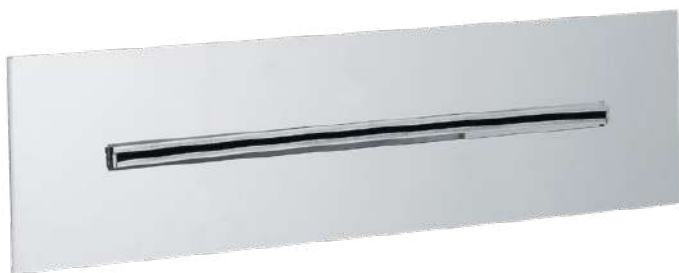

6095 CASSIOPEA - INOX

Cascata ad incasso quadrata.
Built-in waterfall square shape.

Art.		mm.	1 Bar L/min.	2 Bar L/min.	3 Bar L/min.
6095	CR	270x50	11	16	20,5
6095	NI	270x50	11	16	20,5

6105 CASSIOPEA - INOX

Cascata ad incasso arrotondata.
Built-in waterfall round shape.

Art.		mm.	1 Bar L/min.	2 Bar L/min.	3 Bar L/min.
6105	CR	270x50	11	16	20,5
6105	NI	270x50	11	16	20,5



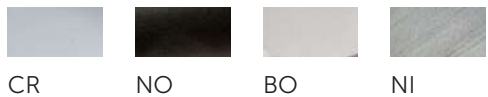

CR NO BO NI

SOFFIONI e BRACCI

INOX

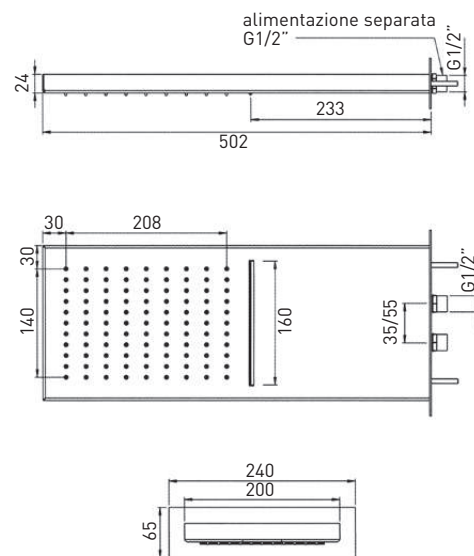
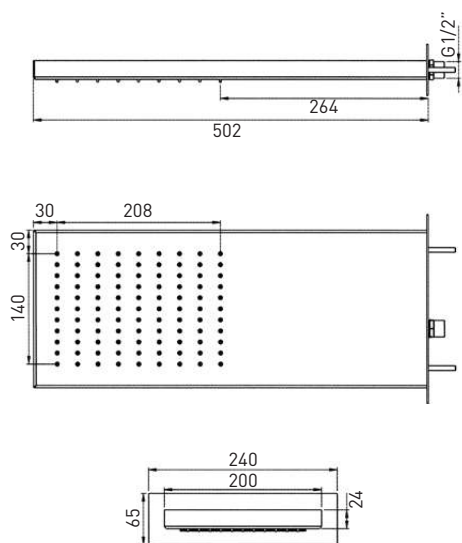

6160 GEMELLI - INOX

Soffione doccia rettangolare.
Rectangular shower head.
Riesenbrausekopf.

6160	1 Bar L/min.	2 Bar L/min.	3 Bar L/min.
CR	4,3	6,5	8,2
NI	4,3	6,5	8,2
BO - NO	4,3	6,5	8,2

6165 GEMELLI - INOX

Soffione doccia rettangolare, con cascata.
Rectangular shower head, with waterfall.
Riesenbrausekopf.

6165	1 Bar L/min.	2 Bar L/min.	3 Bar L/min.
CR	4,3	6,5	8,2
NI	4,3	6,5	8,2
BO - NO	4,3	6,5	8,2

INOX

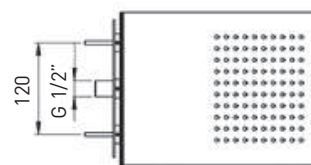
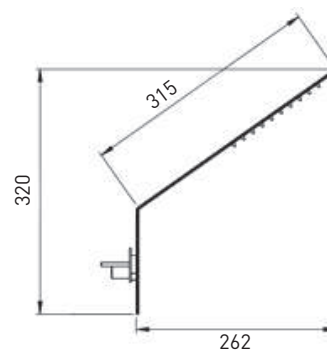
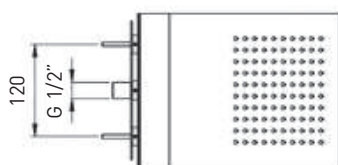
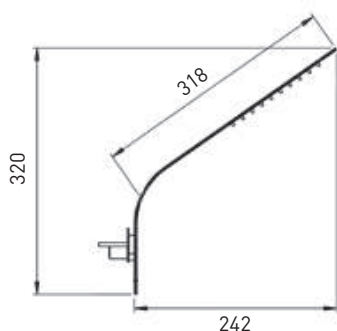

8310 QUARZO - INOX

Soffione doccia ultrasottile.
Ultrathin shower heads.
Riesenbrausekopf.

Art.	1 Bar L/min.	2 Bar L/min.	3 Bar L/min.
8310	4,3	6,5	8,2

8320 QUARZO - INOX

Soffione doccia ultrasottile.
Ultrathin shower heads.
Riesenbrausekopf.

Art.	1 Bar L/min.	2 Bar L/min.	3 Bar L/min.
8320	4,3	6,5	8,2

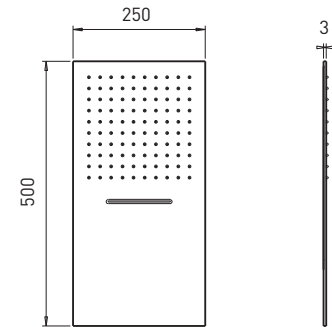
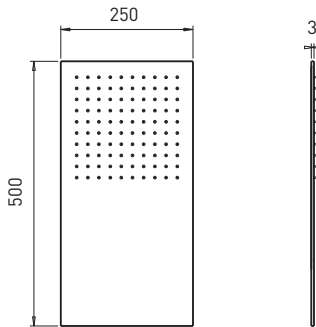

6161 OSCAR - INOX

Soffione doccia rettangolare, ultrapiatto, con getto a pioggia.
Rectangular ultrathin shower head.
Riesenbrausekopf.

Art.	1 Bar L/min.	2 Bar L/min.	3 Bar L/min.
6161	4,3	6,5	8,2

6166 OSCAR - INOX

Soffione doccia rettangolare, ultrapiatto, con getto a pioggia
 e getto a cascata.
Rectangular ultrathin shower head with waterfall.
Riesenbrausekopf.

Art.	1 Bar L/min.	2 Bar L/min.	3 Bar L/min.
6166	4,3	6,5	8,2



INOX

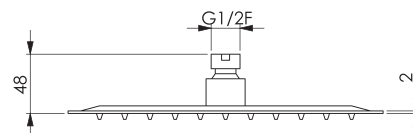
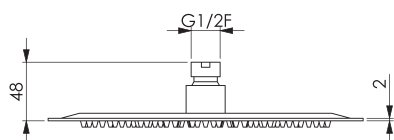
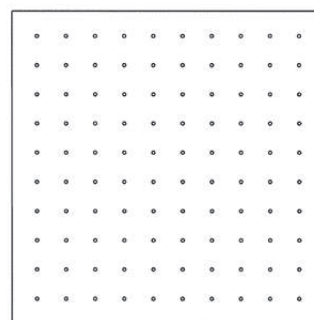
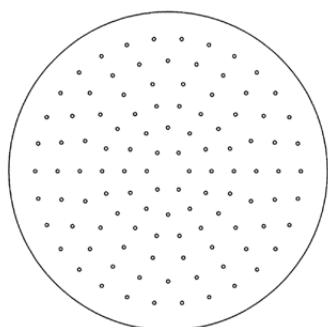
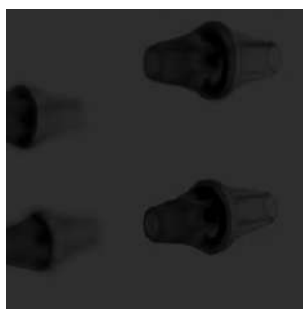

NOTB
Nero opaco total black con ugelli neri

PRIME ROTONDO - INOX

Soffioni doccia tondi ultrapiatti con braccio da 350 mm.
Ultrathin shower heads, in round shape with shower arm 350 mm.
Riesenbrausekopf mit brausenarm 350 mm.

Art.	Ø mm.	1 Bar L/min.	2 Bar L/min.	3 Bar L/min.
14020 CR	200	10	16	21
14020 NI	200	10	16	21
14020 NO	200	10	16	21
14020 GLD-CPR-GNM	200	10	16	21
14025 CR	250	11	17	22
14025 NI	250	11	17	22
14025 NO	250	11	17	22
14025 NOTB	250	11	17	22
14025 GLD-CPR-GNM	250	11	17	22
14030 CR	300	11	17	22
14030 NI	300	11	17	22
14030 NO	300	11	17	22
14030 GLD-CPR-GNM	300	11	17	22
14040 CR	400	12,5	19	23,3

PRIME QUADRATO - INOX

Soffioni doccia quadri ultrapiatti con braccio da 350 mm quadrato.
Ultrathin shower heads, in square shape with shower arm 350 mm.
Riesenbrausekopf mit brausenarm 350 mm.

Art.	mm.	1 Bar L/min.	2 Bar L/min.	3 Bar L/min.
15020 CR	200x200	10	16	21
15020 NI	200x200	10	16	21
15020 NO	200x200	10	16	21
15020 GLD-CPR-GNM	200x200	10	16	21
15025 CR	250x250	11	17	22
15025 NI	250x250	11	17	22
15025 NO	250x250	11	17	22
15025 NOTB	250x250	11	17	22
15025 GLD-CPR-GNM	250x250	11	17	22
15030 CR	300x300	11	17	22
15030 NI	300x300	11	17	22
15030 NO	300x300	11	17	22
15030 GLD-CPR-GNM	300x300	11	17	22
15040 CR	400x400	12,5	19	23,3
15032 CR	200x300	11	17	22





OTTONE ISPEZIONABILE



Ispezionabile
Inspectable



Ispezionabile
Inspectable

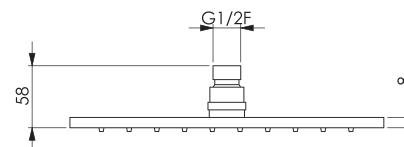
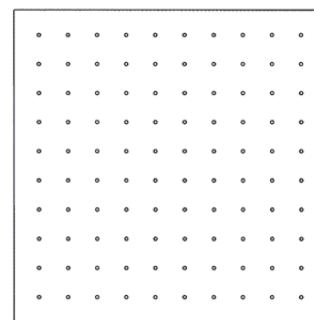
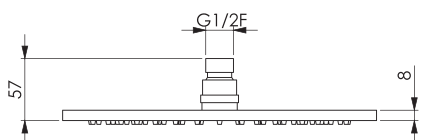
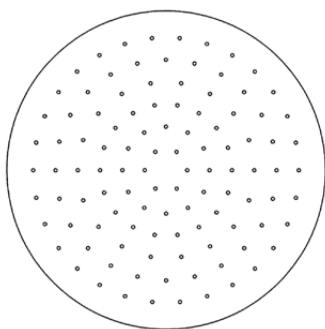

MINERVA ROTONDO - OTTONE cromato

Soffioni doccia tondi con braccio da 350 mm.
Shower heads, in round shape with shower arm 350 mm.
Riesenbrausekopf mit brausenarm 350 mm.

Art.	Ø mm.	1 Bar L/min.	2 Bar L/min.	3 Bar L/min.
16020 CR	200	10	16	21
16020 NI	200	10	16	21
16020 BO - NO	200	10	16	21
16020 BR - RA	200	10	16	21
16020 GLD-CPR-GNM	200	10	16	21
16020 OR	200	10	16	21
16025 CR	250	11	17	22
16025 NI	250	11	17	22
16025 BO - NO	250	11	17	22
16025 BR - RA	250	11	17	22
16025 GLD-CPR-GNM	250	11	17	22
16025 OR	250	11	17	22
16030 CR	300	11	17	22
16030 NI	300	11	17	22
16030 BO - NO	300	11	17	22
16030 BR - RA	300	11	17	22
16030 GLD-CPR-GNM	300	11	17	22
16030 OR	300	11	17	22

MINERVA QUADRATO - OTTONE cromato

Soffioni doccia quadri con braccio da 350 mm quadrato.
Shower heads, in square shape with shower arm 350 mm.
Riesenbrausekopf mit brausenarm 350 mm.

Art.	mm.	1 Bar L/min.	2 Bar L/min.	3 Bar L/min.
17020 CR	200x200	10	16	21
17020 NI	200x200	10	16	21
17020 BO - NO	200x200	10	16	21
17020 BR - RA	200x200	10	16	21
17020 GLD-CPR-GNM	200x200	10	16	21
17020 OR	200x200	10	16	21
17025 CR	250x250	11	17	22
17025 NI	250x250	11	17	22
17025 BO - NO	250x250	11	17	22
17025 BR - RA	250x250	11	17	22
17025 GLD-CPR-GNM	250x250	11	17	22
17025 OR	250x250	11	17	22
17030 CR	300x300	11	17	22
17030 NI	300x300	11	17	22
17030 BO - NO	300x300	11	17	22
17030 BR - RA	300x300	11	17	22
17030 GLD-CPR-GNM	300x300	11	17	22
17030 OR	300x300	11	17	22

SOFFIONI e BRACCI

ABS

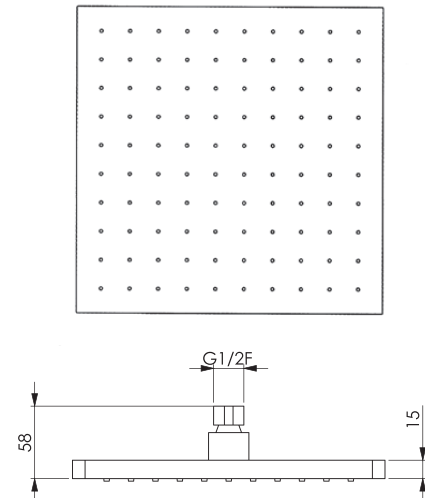
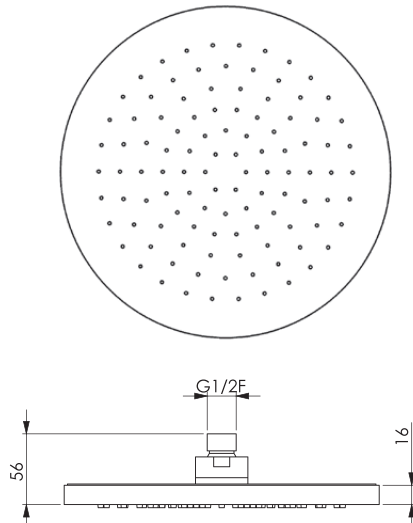

GRAPHITE ROTONDO - ABS cromato

Soffioni doccia tondi con braccio da 350 mm*.
Round shower heads with shower arm 350 mm.*
Riesenbrausekopf mit brausenarm 350 mm.*

*Supplemento braccio da 400 mm
Shower arm 400 mm / Brausenarm 400 mm

Art.	Ø mm.	1 Bar L/min.	2 Bar L/min.	3 Bar L/min.
18020	200	10	16	21
18025	250	11	17	22
18030	300	11	17	22

GRAPHITE QUADRATO - ABS cromato

Soffioni doccia quadro con braccio da 350 mm* quadrato.
Square shower heads with shower arm 350 mm.*
Riesenbrausekopf mit brausenarm 350 mm.*

*Supplemento braccio da 400 mm
Shower arm 400 mm / Brausenarm 400 mm

Art.	mm.	1 Bar L/min.	2 Bar L/min.	3 Bar L/min.
19020	200x200	10	16	21
19025	250x250	11	17	22
19030	300x300	11	17	22





OTTONE

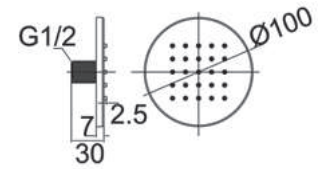

6441

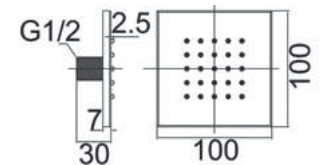
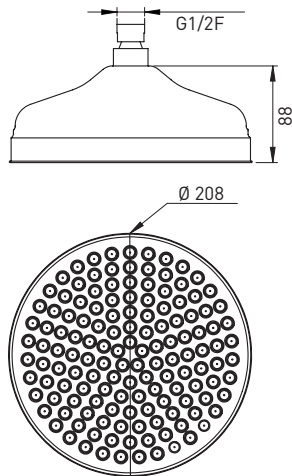

6451

RETRO - OTTONE cromato

Soffioni doccia anticalcare, con braccio in ottone.
Antiscale shower heads, with brass shower arm.
Riesenbrausekopf mit brausenarm.

4220/20	Ø mm.
CR	200
BR - RA - NI	200
OR	200
4220/30	Ø mm.
CR	300
BR - RA - NI	300
OR	300

ALISSO - OTTONE cromato

Soffione doccia in ottone cromato attacco 1/2 M.
Brass shower head, with rubber clean 1/2 M.
Brausekopf 1/2 M.

Art.		mm.
6441	CR	Ø 100
6441	NI	Ø 100
6451	CR	100x100
6451	NI	100x100



CR NO BO NI BR RA GLD CPR GNM OR

OTTONE

3710 - OTTONE cromato

Braccio tondo a soffitto.
Ceiling shower arm.
Decken Brausenarm.

3710/20	mm.
CR	200
BO - NO	200
BR - RA - NI	200
GLD - CPR - GNM	200
OR	200

3710/30	mm.
CR	300
BO - NO	300
BR - RA - NI	300
GLD - CPR - GNM	300
OR	300

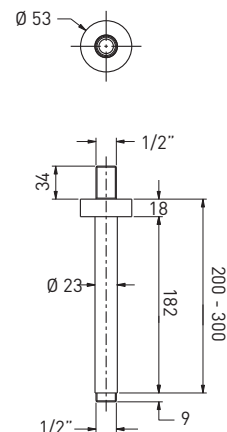

3720 - OTTONE cromato

Braccio quadrato a soffitto.
Ceiling shower arm.
Decken Brausenarm.

3720/20	mm.
CR	200
BO - NO	200
BR - RA - NI	200
GLD - CPR - GNM	200
OR	200

3720/30	mm.
CR	300
BO - NO	300
BR - RA - NI	300
GLD - CPR - GNM	300
OR	300

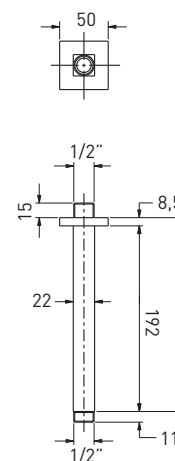
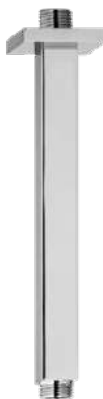

3730 - OTTONE cromato

Braccio tondo, con deviatore.
Ceiling shower arm, with diverter.
Brausenarm.

Art.	mm.
3730	350

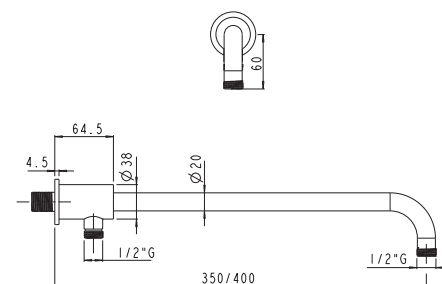

3740 - OTTONE cromato

Braccio quadrato, con deviatore.
Ceiling shower arm, with diverter.
Brausenarm.

Art.	mm.
3740	350

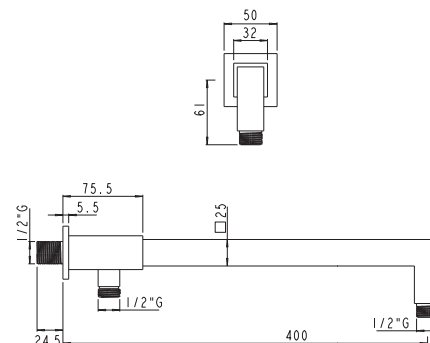

3750 - OTTONE cromato

Braccio doccia.
Shower arm.
Brausenarm.

Art.

3750

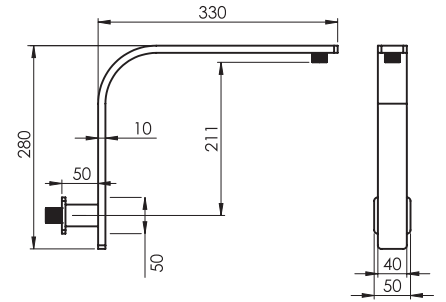

3500

Braccio doccia retrò.
Shower arm.
Brausenarm.

3500

CR

BR - RA - NI

GLD - CPR - GNM

OR

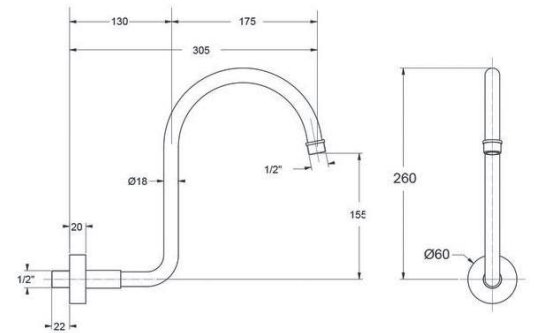

3510

Braccio doccia tondo cm 35.
Shower arm.
Brausenarm.

3510

CR

BO - NO

BR - RA - NI

GLD - CPR - GNM

OR

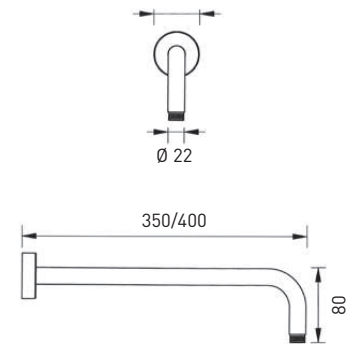

3610

Braccio doccia quadro cm 35.
Shower arm.
Brausenarm.

3610

CR

BO - NO

BR - RA - NI

GLD - CPR - GNM

OR

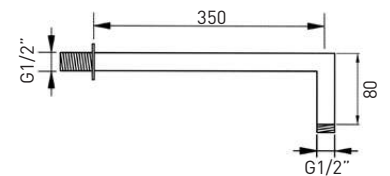

SALISCENDI





5000

Saliscendi ovale in ottone, scorrevole abs, doccia multigetto anticalcare in ABS.
Oval slide bar, in brass, with ABS multijet water softener shower.

Art.
5000



max 680 mm

5020

Saliscendi sez. quadrata completamente in ottone, scorrevole in ottone, doccia abs, regolabile.
Squared sliding rail.

Art.
5020



max 680 mm

5030

Saliscendi minimalista completamente in ottone, scorrevole in ottone, doccia multigetto abs, regolabile.
Round sliding rail.

Art.
5030



5040

Saliscendi sezione quadrata in ottone, scorrevole e doccetta in abs.
Squared sliding rail.

Art.
5040

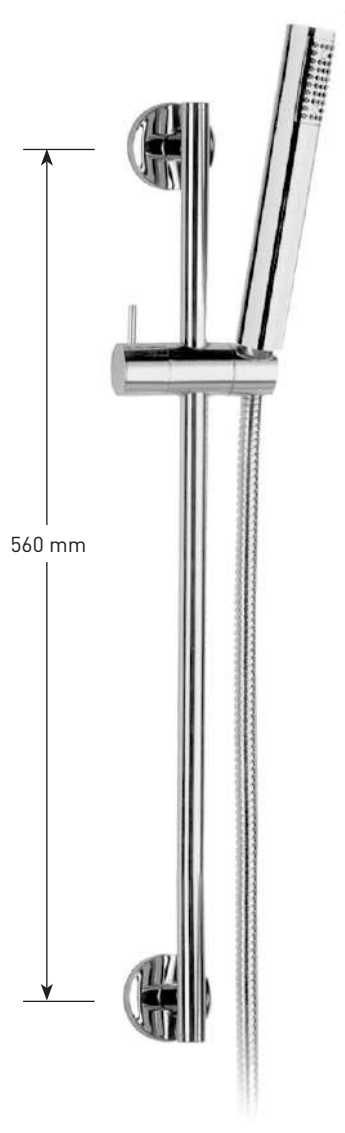

5100

Saliscendi minimalista in ottone, scorrevole e doccetta abs.
Round sliding rail.

Art.
5100



5060

Saliscendi asta \varnothing 25 mm in ottone, scorrevole e doccetta multigetto in abs, regolabile.
Slide bar, in brass, with multijet water softener shower.

Art.
5060



CR



NI



BR



RA



OR



5145

Saliscendi in ottone, scorrevole e doccetta multigetto in abs.
Slide bar, in brass, with multijet water softener shower.

Art.

5145



5150

Saliscendi stile antico completamente in ottone.
Old fashion sliding rail all in brass.

Art.

5150

CR

BR - RA - NI

OR



RUBINETTI ELETTRONICI



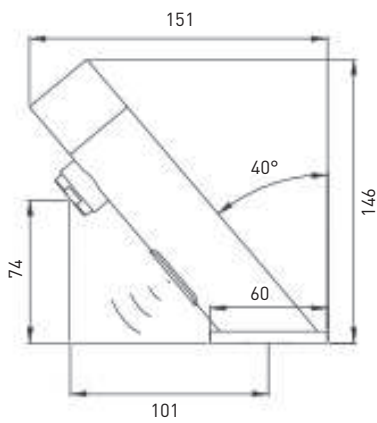

7024B - 7024C

Rubinetto lavabo elettronico
Electronic sink tap

7024B - alimentazione a batteria

CR

7024C - alimentazione a corrente

CR

+ N. 1 x **1200**

Rubinetto sottolavabo con filtro
Under basin tap with filter

1200

CR

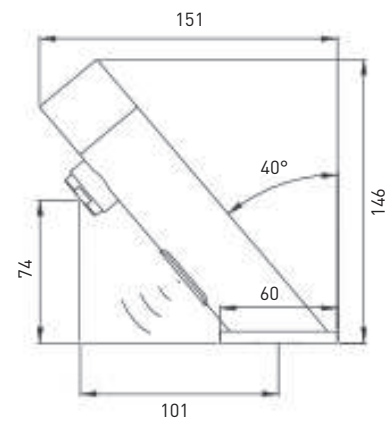

7025B - 7025C

Miscelatore lavabo elettronico
Electronic basin mixer

7025B - alimentazione a batteria

CR

7025C - alimentazione a corrente

CR

+ N. 2 x **1200**

Rubinetto sottolavabo con filtro
Under basin tap with filter

1200

CR

I rubinetti sottolavabo con filtro sono indispensabili per il corretto funzionamento del rubinetto e per la validità della garanzia.
The under basin taps with filter are indispensable for the correct functioning of the tap and for the warranty validity.



RUBINETTI ELETTRONICI

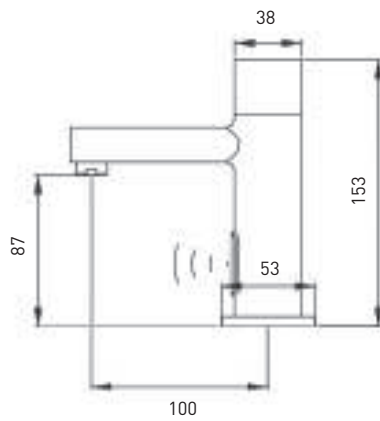

7031B - 7031C

Rubinetto lavabo elettronico
Electronic sink tap

7031B - alimentazione a batteria

CR

7031C - alimentazione a corrente

CR

+ N. 1 x **1200**

Rubinetto sottolavabo con filtro
Under basin tap with filter

1200

CR

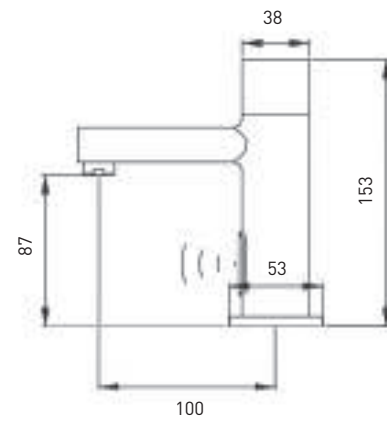

7030B - 7030C

Miscelatore lavabo elettronico
Electronic basin mixer

7030B - alimentazione a batteria

CR

7030C - alimentazione a corrente

CR

+ N. 2 x **1200**

Rubinetto sottolavabo con filtro
Under basin tap with filter

1200

CR

I rubinetti sottolavabo con filtro sono indispensabili per il corretto funzionamento del rubinetto e per la validità della garanzia.
The under basin taps with filter are indispensable for the correct functioning of the tap and for the warranty validity.

ACCESSORI





IF 99 - SA 99

Pres a acqua cilindrica in ottone con supporto.
Completa di flessibile satilux e doccia.
*Round water supply with support.
With luxury flexible and shower.*

IF 99 - con doccia in OTTONE

- CR
- BO - NO
- BR - RA - NI
- GLD - CPR - GNM
- OR

SA 99 - con doccia in ABS

- CR
- BO - NO
- NI

IF 99
OTTONE



SA 99
ABS

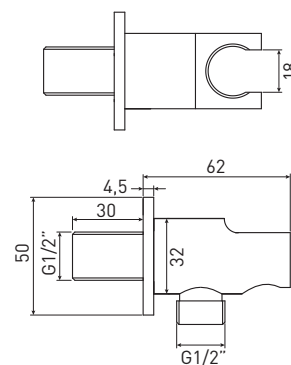

SY 99 - SH 99

Pres a acqua quadrata in ottone con supporto.
Completa di flessibile satilux e doccia.
*Square water supply with support.
With luxury flexible and shower.*

SY 99 - con doccia in OTTONE

- CR
- BO - NO
- BR - RA - NI
- GLD - CPR - GNM
- OR

SH 99 - con doccia in ABS

- CR
- BO - NO
- NI

SY 99
OTTONE



SH 99
ABS

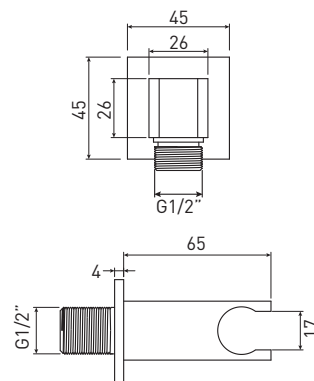

KN 99

Pres a acqua cilindrica in ottone con supporto.
Completa di flessibile satilux e doccia in **ottone**.
*Round water supply with support.
With luxury flexible and shower.*

KN 99 - con doccia in OTTONE

- CR
- BR - RA - NI
- OR

KS 99

Pres a acqua cilindrica in ottone con supporto.
Completa di flessibile satilux e doccia in **ottone**.
*Round water supply with support.
With luxury flexible and shower.*

KS 99 - con doccia in OTTONE

- CR
- BR - RA - NI
- OR

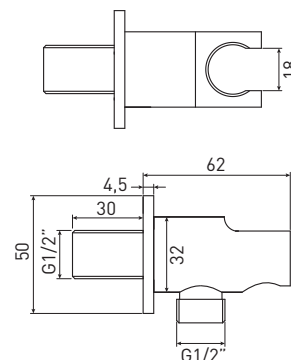
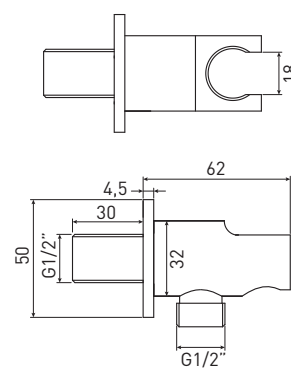

IF 98

Preso acqua cilindrica in ottone.
Round water supply.

IF 98

CR

BO - NO

BR - RA - NI

OR

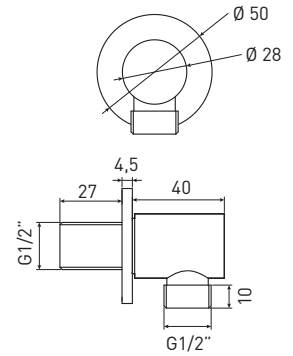

SH 98

Preso acqua quadrata in ottone.
Square water supply.

SH 98

CR

BO - NO

BR - RA - NI

OR

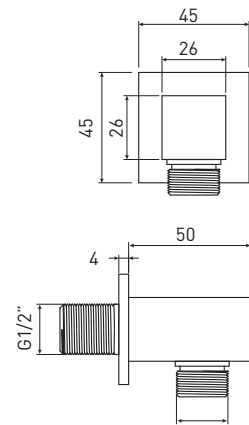

1410

Preso acqua in ottone.
Water supply.

Art.

1410

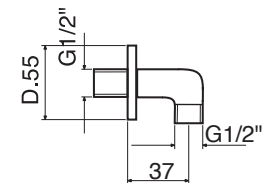

3910

Supporto inferiore in ottone per colonne con
attacco esterno U 3/4" - E 1/2".
Brass lower support for column, outlet
connection.

3910

CR

BO - NO

BR - RA - NI

OR

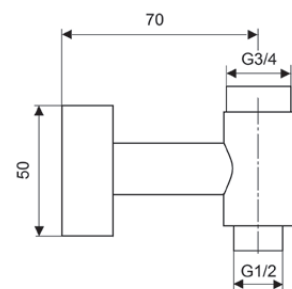
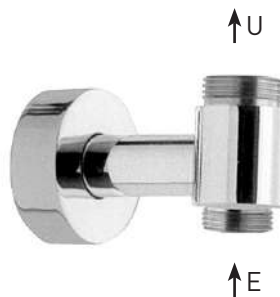



3920

Supporto inferiore in ottone per colonne con presa acqua incasso U 3/4" - E 1/2".
Brass lower support for column, inlet connection.



3920

- _____ CR
- _____ BO - NO
- _____ BR - RA - NI
- _____ OR

3930

Supporto inferiore in ottone per colonne con attacco esterno U 3/4" - E 1/2".
Brass lower support for column, outlet connection.

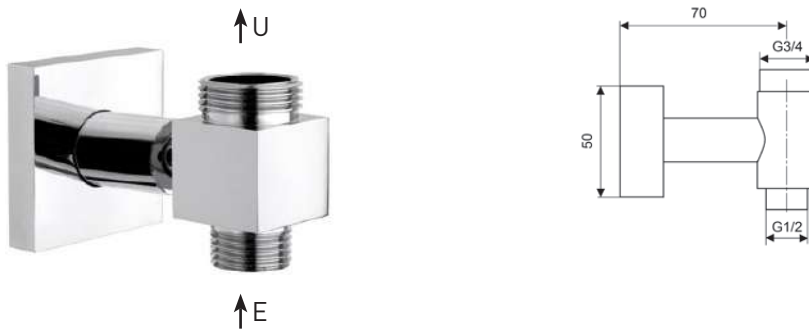

3930

- _____ CR
- _____ BO - NO
- _____ BR - RA - NI
- _____ OR

3940

Supporto inferiore in ottone per colonne con presa acqua incasso U 3/4" - E 1/2".
Brass lower support for column, inlet connection.



3940

- _____ CR
- _____ BO - NO
- _____ BR - RA - NI
- _____ OR

3950

Supporto inferiore in ottone per colonne con attacco esterno U 3/4" - E 1/2".
Brass lower support for column, outlet connection.

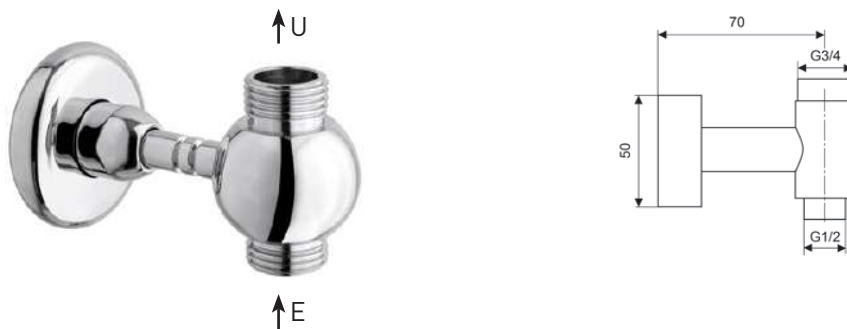

3950

- _____ CR
- _____ BO - NO
- _____ BR - RA - NI
- _____ OR



3960

Supporto inferiore in ottone per colonne con presa acqua incasso U 3/4" - E 1/2".
Brass lower support for column, inlet connection.

3960

CR
 BO - NO
 BR - RA - NI
 OR

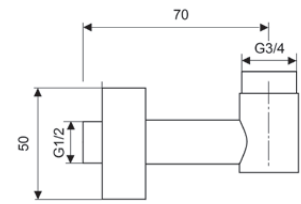

2081

Bocca a parete in ottone cromato.
Bath spout on the wall.
Wandauslauf.

2081

CR
 BO - NO
 BR - RA - NI
 GLD - CPR - GNM
 OR

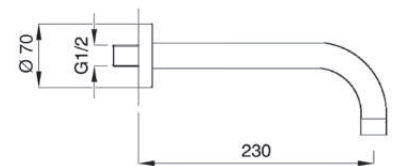

2082

Bocca a parete in ottone cromato.
Bath spout on the wall.
Wandauslauf.

2082

CR
 BR - RA - NI
 OR

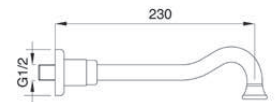

B15 - INOX

Bocca a cascata a parete attacco da 1/2".
S/S wall spout 1/2 M.

Art.
B15

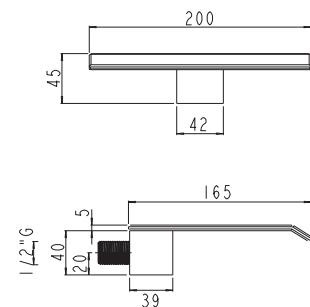



KI 9121

Set **rubinetto** idroscopico in ottone cromato, flessibile doppia aggraffatura cm. 120.
Hydrobrush jet set, brass chrome plated tap, flexible hose double lock cm. 120.

KI 9121

- CR
- BO - NO
- BR - RA - NI
- GLD - CPR - GNM
- OR

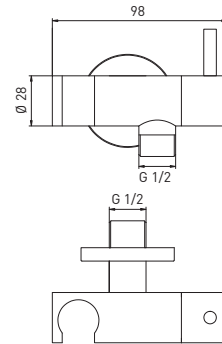

KI 9261

Set **rubinetto** idroscopico in ottone cromato, flessibile doppia aggraffatura cm. 120.
Hydrobrush jet set, brass chrome plated tap, flexible hose double lock cm. 120.

KI 9261

- CR
- BO - NO
- BR - RA - NI
- GLD - CPR - GNM
- OR

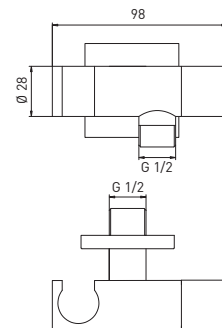

KI 9181

Set **miscelatore** idroscopico in ottone cromato, flessibile doppia aggraffatura cm. 120.
Hydrobrush jet set, brass chrome plated tap, flexible hose double lock cm. 120.

NEW

KI 9181

- CR
- BO - NO
- BR - RA - NI
- GLD - CPR - GNM
- OR

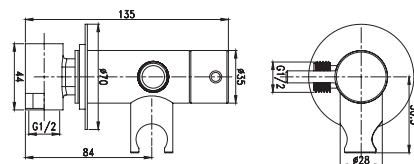

KI 6191

Set **miscelatore** idroscopico in ottone cromato, flessibile doppia aggraffatura cm. 120.
Hydrobrush jet set, brass chrome plated tap, flexible hose double lock cm. 120.

NEW

KI 6191

- CR
- BO - NO
- BR - RA - NI
- GLD - CPR - GNM
- OR

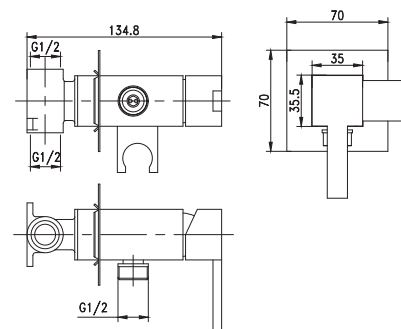

1285

Sifone da arredo in ottone quadro.
Brass syphon chrome.
Siphon.

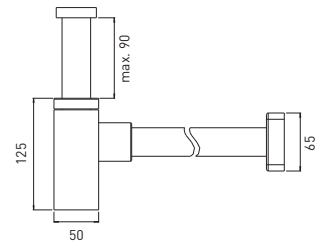

1285

CR
 BO - NO
 BR - RA - NI
 GLD - CPR - GNM
 OR

1290

Sifone da arredo in ottone tondo.
Brass syphon chrome.
Siphon.

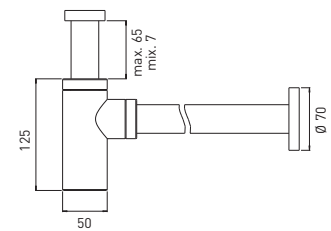

1290

CR
 BO - NO
 BR - RA - NI
 GLD - CPR - GNM
 OR

1103

Scarico Click Clack in ottone,
 regolabile con tappo tondo.
Click Clack pop up.
Click clack ablauf.



1103

CR
 BO - NO
 BR - RA - NI
 GLD - CPR - GNM
 OR

1104

Scarico Click Clack in ottone,
 regolabile con tappo quadro.
Click Clack pop up.
Click clack ablauf.



1104

CR
 BO - NO
 BR - RA - NI
 GLD - CPR - GNM
 OR



1815

Doccetta minimalista tonda in **ABS**.
Abs round minimal shower.
Handbrause minimal.



1815

CR
BO - NO
BR - NI

1816

Doccetta minimalista tonda in **ottone**.
Round minimal brass shower.
Handbrause minimal.



1816

CR
BO - NO
BR - RA - NI
OR
GLD - CPR - GNM

1830

Doccetta minimalista quadra in **ABS**.
Abs square minimal shower.
Handbrause minimal.



1830

CR
BO - NO
BR - NI

1831

Doccetta minimalista quadra in **ottone**.
Square minimal brass shower.
Handbrause minimal.



1831

CR
BO - NO
BR - RA - NI
OR
GLD - CPR - GNM



1820

Doccia antica in ottone.
Old fashion brass shower.
Handbrause antike.

1820

CR
BR - RA - NI
OR



1821

Doccia antica lusso in ottone.
Old fashion brass shower.
Handbrause antike.

1821

CR
BR - RA - NI
OR



1850

Doccia multigetto anticalcare in abs.
Abs multijet handshower with rubber clean.
Handbrause.

Art.

1850



1855

Doccia monogetto anticalcare in abs.
Abs monojet handshower with rubber clean.
Handbrause.

Art.

1855





1860

Doccia idromassaggio anticalcare multigetto abs.
Multijets hydromassage abs handshower with rubber clean.
Handbrause mit Wasserstrahlmass.

Art. _____
1860



1861

Doccia idromassaggio anticalcare lusso multigetto abs.
Multijets hydromassage abs handshower with rubber clean.
Handbrause mit Wasserstrahlmass.

Art. _____
1861



1900

Doccia cucina 2 getti in abs.
Kitchen handshower 2 jets.
Handbrause.

Art. _____
1900



1600

Flessibile doccia Satilux.
Satilux flexible.
Flexibel.

Art.		cm.
1600/150	CR	150
1600/150	NO - BO	150
1600/200	CR	200
1600/200	NO - BO	200



1620

Flessibile doccia doppia aggraffatura in ottone.
Double locked chromed flexible hose.
Flexibel doppelklammer.

1620/150 cm. 150

CR

BR - RA - NI

GLD - CPR - GNM

OR

1620/200 cm. 200

CR

BR - RA - NI

OR



1910

Flessibile cucina doppia aggraffatura in ottone con contrappeso.
Double locked chromed flexible hose, with counterweight.
Flexibel doppelklammer.

1910/150 cm. 150

CR

BR - RA - NI

OR

1910/200 cm. 200

CR

BR - RA - NI

OR



1000

Cartuccia ø 35 mm con distributore.
Ceramic cartridge ø 35 mm with distributor.
Kartusche ø 35 mm.

Art.

1000



1001

Cartuccia ø 35 mm senza distributore.
Ceramic cartridge ø 35 mm without distributor.
Kartusche ø 35 mm.

Art.

1001



1011

Cartuccia termostatica.
Thermostatic cartridge.
Kartusche.

Art.

1011

NEW





CR NO BO NI BR RA OR

1005

Cartuccia ø 40 mm con distributore.
Ceramic cartridge ø 40 mm with distributor.
Kartusche ø 40 mm.

Art. _____

1005



1006

Cartuccia ø 40 mm senza distributore.
Ceramic cartridge ø 40 mm without distributor.
Kartusche ø 40 mm.

Art. _____

1006



1008

Cartuccia ø 25 mm.
Ceramic cartridge ø 25 mm.
Kartusche ø 25 mm.

Art. _____

1008



1009

Cartuccia ø 30 mm.
Ceramic cartridge ø 30 mm.
Kartusche ø 30 mm.

Art. _____

1009



1010

Vitone ceramico.
Ceramic disk valve.
Oberteil aus keramik.

Art. _____

1010



1206

Rubinetti tondo sottolavabo in ottone
1/2M x 3/8M, senza filtro.
Brass round underbawash basin tap 1/2M x 3/8M.

1206

CR
NO - BO
BR - RA - NI
OR



1207

Rubinetti quadrato sottolavabo in ottone
1/2M x 3/8M, senza filtro.
Brass squared underbawash basin tap 1/2M x 3/8M.

1207

CR
NO - BO
BR - RA - NI
OR



RV 4000

Rubinetti sottolavabo con filtro 1/2M x 3/8M.
Brass underbawash basin tap 1/2M x 3/8M.

RV 4000

CR

NEW



RV 4200

Rubinetti sottolavabo con filtro e snodo
1/2M x 3/8M.
Brass underbawash basin tap 1/2M x 3/8M.

RV 4200

CR
BR - RA
OR

NEW





CR NO BO NI BR RA OR

1263

Colonna scarico in ottone, minimalista.
Brass drain column.

1263

- _____
- CR _____
- NO - BO _____
- BR - RA - NI _____
- OR _____



1264

Colonna scarico in plastica, minimalista.
Plastic drain column.

1264

- _____
- CR _____
- NO - BO _____
- BR - RA - NI _____
- OR _____



1265 - OTTONE

Colonna scarico in ottone, click clack.
Brass drain column.

1265

- _____
- CR _____
- NO - BO _____
- BR - RA - NI _____
- OR _____



1266

Colonna scarico in plastica, click clack.
Plastic drain column.

1266

- _____
- CR _____
- NO - BO _____
- BR - RA - NI _____
- OR _____



VK DESIGN



SI 63

Rubinetto con portagomma
Bibcock with hose connection

SI 63

CR - cromo

BR - bronzo

RA - rame

NI - nickel

OR - oro

FU - fucsia

BL - blu

BO - bianco opaco

NO - nero opaco



SI 63 CR

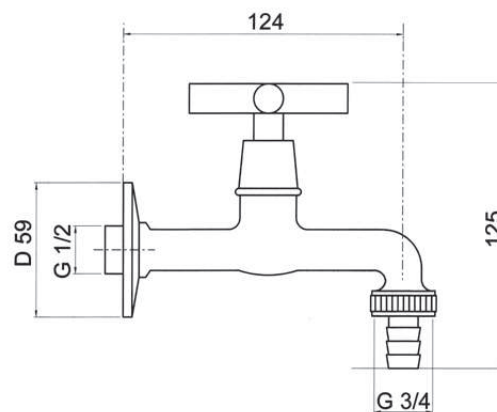

SI 63 BR



SI 63 RA



SI 63 NI



SI 63 OR



SI 63 FU



SI 63 BL



SI 63 BO



SI 63 NO

CONDIZIONI DI VENDITA

- 1) Con il conferimento dell'ordine il cliente accetta pienamente e tacitamente tutte le nostre condizioni di vendita e di consegna sottostanti.
- 2) I prezzi si intendono per merce resa franco nostro stabilimento di Gozzano. I prezzi dei nostri listini sono soggetti a variazioni e non sono impegnativi. Ogni ordine comunque conferito potrà essere ritenuto valido solo se da noi accettato.
- 3) I termini di pagamento specificati in fattura si intendono tassativi: ogni variazione, che non sia stata preventivamente ed espressamente pattuita, verrà respinta. Sono liberatori solo i pagamenti delle fatture eseguiti al nostro domicilio in Gozzano, salvo accordi speciali di pagamenti a termine. Il ritardato pagamento delle forniture darà luogo all'addebito degli interessi bancari. Al verificarsi di pagamenti non eseguiti nei termini convenuti è nostra facoltà sospendere le consegne e gli eventuali ordini già accettati. Si precisa che nessun pagamento potrà essere differito in caso di contestazione. Eventuali aggiunte o modifiche effettuate dal cliente su ordini da lui trasmessi saranno prive di validità se non comunicate in forma scritta.
- 4) I tempi di consegna si intendono approssimativi e non impegnativi essendo essi vincolati alle possibilità del momento. La mancata osservanza da parte nostra dei termini di consegna indicati, non dà diritto al cliente di annullare l'ordine, differire pagamenti o reclamare indennizzi, compensi, penali o danni di sorta. Quanto sopra vale anche nei casi in cui la mancata osservanza dei termini di consegna è conseguente a carenza di materie prime, avarie del macchinario, scioperi, serrate, epidemie, interruzione o ritardi nei trasporti.
- 5) Consegna merci: la Rubinetteria Keller Taps si impegna a far ritirare la merce o al vettore di sua fiducia o al vettore indicato dal compratore, per il trasporto alla destinazione indicata dal compratore stesso. In ogni caso, anche quando le spese di trasporto faranno carico alla Rubinetteria Keller Taps, la merce si intende consegnata al compratore nel luogo di consegna al vettore designato. Dalla rimessa della merce al vettore per il trasporto, il venditore è liberato da ogni rischio e responsabilità relativamente ad essa.
- 6) La merce viaggia a rischio e pericolo del committente anche se la spedizione è effettuata in porto franco, l'Azienda declina ogni responsabilità per ritardi, guasti, avarie, rotture, ammacchi che si verificassero durante il trasporto. Spetta al committente presentare eventuali reclami al trasportatore, anche se questo è stato scelto dalla Keller Taps. La Keller Taps si riserva la facoltà di addebitare al Cliente gli oneri aggiuntivi al puro costo di trasporto (es. soste, operazioni di scarico particolari, ecc.) eventualmente corrisposti al vettore.
- 7) Tutti i nostri articoli sono accuratamente provati e controllati. La nostra responsabilità sulla qualità del materiale si limita, previa nostra autorizzazione, ad accettare il reso, in porto franco, di prezzi riscontrati difettosi per disporre la sostituzione, senza essere tenuti a corrispondere alcun indennizzo. Non possiamo inoltre accettare alcuna responsabilità ove i materiali da noi forniti risultassero manomessi. Si esclude qualsiasi tipo di risarcimento per danni diretti o indiretti causati dalla posa in opera di materiale difettoso. È fatto assoluto divieto agli acquirenti di effettuare qualsiasi lavorazione ulteriore sui prodotti di nostra produzione. Non riceveremo merce in restituzione se non sarà da noi autorizzato o non sarà inviata con nostro corriere convenzionale.
- 8) Le illustrazioni dei nostri cataloghi e depliant hanno lo scopo di dimostrare e rappresentare i singoli articoli e non costituiscono quindi obbligo di fedele esecuzione. I dettagli, le misure ed i pesi indicati sono da considerarsi approssimativi. Pertanto non ci assumiamo alcuna responsabilità in ordine a quanto sopra e conseguentemente non riconosceremo richieste per danni di qualsiasi specie.
- 9) Per qualsiasi contestazione è sempre e solo competente il foro di Novara (Italia), anche se gli ordini siano rimessi altrove. Non hanno alcun valore e non vengono da noi riconosciute dichiarazioni, impegnative o garanzie di sorta assunte da nostri dipendenti, agenti o rappresentanti, che non risultano dalle presenti condizioni generali di vendita o da atti ufficialmente sottoscritti dalla Società.
- 10) Riserva di proprietà. La merce consegnata rimane di riservato dominio della fornitrice fino all'avvenuto pagamento.

GENERAL TERMS OF SALE

- 1) Passing the order, the Customer fully and tacitly accepts all the below mentioned sale and delivery terms.
- 2) Prices are quoted Ex Works. Prices are subject to change and are binding only on the Customer. Every order is valid only after our acceptance.
- 3) Payment terms in the Invoice are peremptory. Every change that is not previously and expressly agreed will be refused. Payments of Invoice made in our Registered Office are in settlement, apart special agreements for payments on expired date. The delayed payment causes the debit of bank interest. In case of payment effected not in the agreed terms, Keller Taps reserves to stop the delivery and the already accepted orders. Payment cannot be postponed in case of claim. Eventual variations or additions are accepted only if the notice is written.
- 4) Delivery time is approximate and not binding since it depends on the possibility at the moment. Our non observance of the delivery time does not entitle the Customer to cancel the order, to postpone payments, to claim damage and compensation. The above mentioned is also valid in case of lack of raw materials, strikes, damages in the machines, epidemics, stop or delay in trasport.
- 5) Rubinetterie Keller Taps undertakes to have the goods picked up either by its trusted carrier or by the carrier indicated by the buyer, for transportation to the destination indicated by the buyer. In any case, even when the transport expenses are borne by Rubinetterie Keller Taps, the goods are understood as delivered to the buyer in the place of delivery indicated to the carrier. Starting from the moment when the goods are given to the carrier for the transportation, the seller is free from any risk and responsibility relating to the shipment of the goods themselves.
- 6) Delivery: Goods are carried at the customer's risk even if shipped free place of destination. We disclaim any responsibility for delays, damages, breakdowns occurred during the transport. The Customer presents possible claims to the carrier, even if it was chosen by Keller Taps. Keller Taps reserves to charge additional costs to the Customer at the pure cost of transport eventually due to the carrier.
- 7) All our products are carefully tested. With reference to the quality of materials, our responsibility is limited to accept the return of goods, upon written authorisation, free collect, for examination. We are not obliged to allow any damages. We cannot accept any responsibility if the materials result to be tampered. We exclude any claim for direct or indirect damages caused by installation of defect materials. It is strictly forbidden to effect any further processing on our products. We do not receive goods on return if they are not authorised and if they are not
- 8) The illustration in our catalogues and brochures show and represent the single articles. We are not obliged to produce them faithfully. The details, sizes and weights are approximate. We decline all responsibility for the above and we do not accept any claims for damages.
- 9) Any controversy will always be within the competence of the Court of Novara (Italy), even if the orders are accepted anywhere. Any statement or warranty not included in this agreement and made by our agents, representatives and workers are no worth and are not recognised by our Company.
- 10) Reserve of property. The delivered goods are property of the supplier until payment is effected.

ALLGEMEINE GESCHÄFTSBEDINGUNGEN

- 1) Mit der Warenbestellung akzeptiert der Kunde vollständig und stillschweigend alle nachstehenden Geschäftsbedingungen der Firma Keller Taps.
- 2) Die Preise verstehen sich ab Werk. Die Listenpreise können sich ändern und sind unverbindlich. Ein Auftrag, wie auch immer erteilt, ist nur gültig, wenn er bestätigt wird.
- 3) Die in der Rechnung angegebene Zahlungsweise ist verbindlich; jede Abweichung, die nicht vorher ausdrücklich vereinbart wurde, wird nicht akzeptiert. Nur Zahlungen von Rechnungen, die an den Sitz der Gesellschaft in Gozzano geleistet werden, wirken befreiend, es sei denn, es wurden besondere abweichende Vereinbarungen bei Terminzahlungen getroffen. Bei verspäteter Zahlung von Lieferungen werden Verzugszinsen berechnet. Bei nicht vereinbarungsgemäß erfolgten Zahlungen behält sich die Firma Keller Taps vor, die Lieferungen einzustellen und eventuell bereits bestätigte Aufträge nicht auszuführen. Reklamationen rechtfertigen keinen Zahlungsverzug. Eventuelle Ergänzungen oder Änderungen des Auftrags durch den Kunden sind nur in schriftlicher Form gültig.
- 4) Die genannten Lieferzeiten sind unverbindlich, da sie von den momentan gegebenen Möglichkeiten abhängig sind. Die Nichteinhaltung von angegebenen Lieferzeiten berechtigt den Kunden nicht zur Stornierung des Auftrages, zur Verzögerung der Zahlung, zur Geltendmachung von Entschädigungsleistungen, Ausgleichszahlungen, Strafgeldern oder irgendwelcher Schäden. Dies gilt auch für den Fall, dass die Nichteinhaltung der Lieferfrist durch den Mangel von Rohstoffen, Maschinenschäden, Streiks, Aussperrungen, Epidemien und durch Unterbrechungen oder Verzögerungen beim Transport verursacht wird.
- 5) Lieferung: Die Rubinetterie Keller Taps sorgt dafür, dass die Ware entweder von einem Transporteur ihres Vertrauens oder vom Transportunternehmen abgeholt wird, das der Käufer angegeben hat und dann zum vom Käufer angezeigten Bestimmungsort transportiert wird. Auf jeden Fall gilt, auch wenn die Rubinetterie Keller Taps die Frachtkosten trägt, die Ware dem Käufer an dem Ort zugestellt, die dem Transporteur vorgegeben wurde. Von der Übergabe der Ware an das Transportunternehmen an ist der Verkäufer von jeglichen Risiken und diesbezüglicher Verantwortung entbunden.
- 6) Der Versand der Ware erfolgt auf Risiko des Käufers, auch wenn er frachtfrei erfolgt. Das Unternehmen übernimmt keine Haftung für Verzögerungen, Schäden, Bruch oder Fehlbestände, die während des Transports entstehen. Der Käufer hat eventuelle Reklamationen direkt an das Transportunternehmen zu richten, auch wenn dieser von der Firma Keller Taps gewählt wurde. Keller Taps behält sich die Weiterberechnung von Kosten an den Kunden vor, die über die reinen Transportkosten hinaus anfallen sollten (z.B. Haltezeiten, spezielle Entladungstätigkeiten usw.) und die dem Beförderer eventuell erstattet wurden.
- 7) Alle Keller Taps-Produkte sind sorgfältig geprüft und erprobt. Die Haftung hinsichtlich der Produktqualität beschränkt sich auf die frachtfreie Rücknahmen von mangelhaften Teilen zwecks Ersatzlieferung, jedoch nur nach vorheriger Genehmigung, ohne Verpflichtung zu irgendwelchen Entschädigungsleistungen. Weiterhin wird keine Haftung für den Fall übernommen, dass die gelieferten Produkte manipuliert wurden. Jeglicher Schadensersatz für direkte oder indirekte Schäden, die durch den Einbau mangelhafter Teile verursacht wurden, ist ausgeschlossen. Dem Käufer ist es kategorisch untersagt, die Produkte Keller Taps auf irgendwelche Weise weiter zu bearbeiten. Es wird keine Rückgabe von Ware ohne vorherige Genehmigung durch Keller taps akzeptiert. Dies gilt auch für den Fall, dass der Transport nicht durch Vertragsunternehmen der Firma Keller Taps erfolgt ist.
- 8) Die Abbildungen in den Keller Taps-Katalogen und Prospekten haben den Zweck, die Produkte anschaulich darzustellen. Sie beinhalten daher nicht die Verpflichtung zum getreuen Nachbau. Bei den angegebenen Details, Abmessungen und Gewichte handelt es sich um Richtwerte. Es wird daher diesbezüglich keine Verantwortung übernommen und infolgedessen werden keine Ansprüche wegen Schäden irgendwelcher Art anerkannt.
- 9) Zuständiger Gerichtsstand für Auseinandersetzungen jeglicher Art ist NOVARA (Italien), auch wenn der Auftrag woanders erteilt worden ist. Es gilt das Italienische Recht. Keinerlei Gültigkeit haben Erklärungen, Verpflichtungen oder irgendwelche Garantien, die von den Mitarbeitern, Handelsvertretern oder Vertretern der Firma Keller taps abgegeben bzw. übernommen wurden, wenn sie nicht mit den vorliegenden allgemeinen Geschäftsbedingungen übereinstimmen oder sich nicht aus offiziell von der Gesellschaft Keller taps unterzeichneten Dokumenten ergeben.
- 10) Eigentumsvorbehalt. Die gelieferte Ware bleibt Eigentum des Herstellers bis zu ihrer vollständigen Bezahlung.

GARANZIA PRODOTTI

I prodotti Keller Taps, rigorosamente collaudati prima di essere posti in vendita, sono garantiti da difetti di fabbricazione per un periodo di 10 anni per le finiture cromo di 2 anni per tutte le altre finiture a partire dalla data di acquisto (farà fede la data della ricevuta di acquisto). L'usura delle cartucce ceramiche nei miscelatori monocomando, dei vitoni tradizionali e dei vitoni ceramici dipende dalla qualità dell'acqua: Keller Taps garantisce queste parti per 5 anni quando siano stati installati i rubinetti sottolavabo, vengano rispettati i valori di pressione di alimentazione consigliati e l'acqua presenti dei valori di durezza medi.

La garanzia comprende difetti di fusione, difetti di porosità e difetti di cromatura e consiste nella riparazione del pezzo riscontrato difettoso dopo la verifica da parte di Keller Taps e dietro presentazione della ricevuta d'acquisto.

La garanzia decade nel caso si riscontrino:

- Deterioramento delle superfici cromate dovuto all'uso di prodotti per la pulizia contenenti acidi o sostanze abrasive.
- Deterioramento delle superfici con finiture diverse da quelle cromate. La loro durata è infatti subordinata alla cura ed alla delicatezza d'uso da parte dell'utente.
- Deterioramento della rubinetteria imputabile ad installazione effettuata in modo non corretto.
- Utilizzo della rubinetteria in modo non corretto.
- Riparazione e manutenzione effettuate in modo non idoneo e senza preventiva autorizzazione dell'Azienda.

La garanzia non include le spese di manodopera per la sostituzione dei pezzi difettosi, né la richiesta di risarcimenti per danni diretti od indiretti subiti od insorti. La garanzia Keller Taps non è rinnovabile.

WARRANTY

All Keller Taps products are carefully tested before they are put on sale. Chrome and zirconium- finish products are guaranteed against production defects for 10 years while products with other finishes are guaranteed for 2 years as from the date of purchase date (as proven by receipt of payment). Wear on ceramic cartridges in single-lever mixers, traditional large screws and ceramic large screws depends on the quality of the water. Keller Taps guarantees these components for 5 years where a beneath-basin filter cock has been installed and where recommended water supply pressure is observed and water is of medium hardness.

The warranty covers casting defects, porosity defects and chrome-plating defects. We will repair or replace the faulty piece after examination and upon production of the receipt to confirm the purchase date.

The warranty does not apply to damage resulting from:

- Deterioration of chrome surfaces caused by the use of acid or abrasive cleaning products.
- Deterioration of surfaces with finishes other than chrome. Their lifespan depends on the care taken by the user.
- Improper installation.
- Improper use.
- Repair and maintenance carried out under unsuitable circumstances and without prior authorisation from Keller Taps.

The warranty does not include the labour charges incurred in replacing the faulty pieces, nor any claims for direct or indirect, damages suffered or arisen. The Keller Taps warranty cannot be renewed.

GARANTIE

Alle KELLER TAPS Produkte werden geprüft bevor sie in den Verkauf kommen. Chrom- und Zirkoniumbeschichtete Produkte haben 10 Jahre Garantie für Produktionsfehler, während Produkte mit anderen Farbbeschichtungsflächen 2 Jahr Garantie ab dem Verkaufsdatum haben (RECHNUNGSDATUM). KELLER TAPS gibt 5 Jahre Garantie auf die Keramikkartuschen sowie Keramikoberteile, wenn die Installation nach DIN 1988, Hauswasserstation eingebaut sind oder zu diesem Zeitpunkt nachweislich Installiert wurde. Ein Wasserversorgungsdruck von 3,8 Bar darf nicht überschritten werden. Eine Wasserqualität mittlere Härte ist noch vertretbar Härtebereich 3.

Die Garantie bezieht sich auf Defekte, Porosität und Verchromungsdefekte. KELLER TAPS wird das fehlerhafte Stück nach Prüfung des Sachverhaltes gegebenenfalls ersetzen, wobei das Rechnungsdatum mit berücksichtigt wird.

Die Garantie schließt folgendes nicht ein: KELLER TAPS Armaturen müsse durch einen Fachhandwerker installiert werden.

- Beschädigung von Chrom- und Zirkonium Oberflächen, die durch die Verwendung von Säure oder Scheuermitteln bei der Reinigung verursacht wurden.
- Beschädigung von Farbbeschichtungsflächen, verursacht durch die Verwendung von Säure oder Scheuermitteln bei der Reinigung.
- Fehlerhafte Installation.
- Unzeckmäßige Verwendung.
- Reparatur durch nicht ausdrücklich autorisierten Fachhandwerksbetrieb von KELLER TAPS.

Die Garantie schließt die Arbeitskosten nicht ein, die zum Ersetzen der fehlerhaften Stücke anfallen, ebenso irgendwelche Behauptungen für direkt oder indirekt erlittenen Schäden, die entstanden sein sollen. Die KELLER TAPS Garantie kann nicht verlängert werden.

Concept & photo: SGP Creativa - Omegna
Photo at pages 4-5-6-7-8-9 courtesy granted by CIPI' Bathroom

©2021 KELLER TAPS - Gozzano - NO - Italy
Edition 10/2021

Le illustrazioni della presente pubblicazione, nonché le descrizioni e i dati riportati, sono indicativi e possono essere soggetti a modifiche senza preavviso.
Illustrations, descriptions, and data in this publication are for informational purpose and may be amended without prior notice*.

Die, in dieser Veröffentlichung dargestellten Abbildungen, sowie die angeführten Beschreibungen und Angaben sind rein hinweisend und können ohne Vorankündigung Abänderungen unterzogen werden.



Rubinetteria
KELLER TAPS s.r.l.

Uffici e produzione
Via Martiri delle Foibe, 4
28024 - GOZZANO (NO) - Italy
Tel. e Fax +39 0322 1958151
Email: info@kellertaps.com

www.kellertaps.com

Sede legale
Via Milano, 5
21052 - BUSTO ARSIZIO (VA) - Italy